

TECHNICAL CATALOGUE

YUTAKI

R32 / R410A SERIES

MODELS

SPLIT SYSTEM

YUTAKI S: RWM-(2.0-10.0)(N/R)1E

YUTAKI S COMBI: RWD-(2.0-6.0)(N/R)W1E-220S(-K)

OUTDOOR UNITS: RAS-(2-3)WHVRP1 / RAS-(4-10)WH(V)NPE



Cooling & Heating

Contents

General information	1
General data	2
Capacity and selection data	3
Acoustic characteristic curves	4
Working range	5
General dimensions	6
Refrigerant cycle and hydraulic circuit	7
Refrigerant and water piping	8
Electrical and control settings	9
LCD Controller	10
Optional functions	11
Complementary system CASCADE CONTROLLER	12

General Index

1.	General information.....	1
1.1	General information.....	2
1.1.1	General notes.....	2
1.1.2	Introduction.....	2
1.1.2.1	Overview of YUTAKI system.....	2
1.1.2.2	Summary of operations.....	3
1.2	Applied symbols.....	4
1.3	Norms and Regulations.....	4
1.4	Product guide.....	5
1.4.1	Classification of the units.....	5
1.4.1.1	Split system - Outdoor unit.....	5
1.4.1.2	Split system - Indoor unit.....	5
1.4.2	Product guide.....	6
1.4.2.1	Split system - Outdoor unit.....	6
1.4.2.2	Split system - Indoor unit.....	6
1.4.3	Accessory code list.....	9
1.4.4	Outdoor unit accessories code list.....	12
2.	General data.....	15
2.1	Capacity tables.....	16
2.2	ERP performance data (Preliminary data).....	19
2.2.2.2	ERP data - YUTAKI S COMBI.....	25
2.2.2.3	ERP additional data - YUTAKI S.....	30
2.2.2.4	ERP additional data - YUTAKI S COMBI.....	31
2.2.3	General ERP data for combi heaters.....	32
2.2.3.1	YUTAKI S COMBI.....	32
2.2.3.2	General ERP data for hot water storage tanks (YUTAKI S).....	33
2.3	Cooling mode application (EN 14825) (Models with cooling kit accessory) (Preliminary data).....	34
2.3.1	Cooling data (EN 14825) - YUTAKI S.....	34
2.3.2	Cooling data (EN 14825) - YUTAKI S COMBI.....	38
2.3.3	Additional Cooling data (EN 14825) - YUTAKI S.....	40
2.3.4	Additional Cooling data (EN 14825) - YUTAKI S COMBI.....	42
2.4	General specifications.....	43
2.4.2	Split system - Outdoor unit (Preliminary data).....	43
2.4.4	Domestic Hot Water Tank.....	50
2.5	Component data (Preliminary data).....	51
2.5.1	Split system - Outdoor unit.....	51
2.5.2	Split system - Indoor unit.....	53
2.5.2.1	YUTAKI S.....	53
2.5.2.2	YUTAKI S COMBI.....	54
2.6	Electrical data.....	56
2.6.2	Split system - Outdoor unit.....	56
2.6.3	Split system - Indoor unit.....	57

2.6.3.1 YUTAKI S	57
2.6.3.2 YUTAKI S COMBI	58
3. Capacity and selection data.....	59
3.1 YUTAKI S	60
3.1.1 Maximum heating capacity table (kW) (Integrated) (Standard Humidity).....	60
3.1.2 Maximum heating capacity table (kW) (Integrated) (High Humidity condition) (Only for RAS-(2-3)WHVRP1 outdoor combination models).....	62
3.1.3 Maximum cooling capacity table (kW).....	63
3.2 YUTAKI S COMBI	65
3.2.1 Maximum heating capacity table (kW) (Integrated) (Standard Humidity).....	65
3.2.2 Maximum heating capacity table (kW) (Integrated) (High Humidity condition) (Only for RAS-(2-3)WHVRP1 outdoor combination models).....	66
3.2.3 Maximum cooling capacity table (kW)	67
3.3 Correction factors.....	68
3.3.1 Piping length correction factor.....	68
3.3.2 Correction factor depending on the altitude	71
4. Acoustic characteristic curves.....	73
4.1 Considerations	74
4.2 Sound pressure level for Outdoor unit.....	75
5. Working range.....	77
5.1 Power supply working range	78
5.2 Temperature working range.....	78
5.2.1 Space heating	78
5.2.2 DHW.....	79
5.2.3 Swimming pool heating	80
5.2.4 Space cooling (Necessary cooling kit)	80
5.3 Hydraulic working range.....	81
5.3.1 Hydraulic data	81
5.3.2 Pump performance curves	81
6. General dimensions.....	85
6.1 Name of parts and Dimensional data.....	86
6.1.1 Split system - Outdoor unit	86
6.1.2.2 YUTAKI S COMBI	91
6.2 Service space.....	92
6.2.1 Split system - Outdoor unit.....	92
6.2.2 Split system - Indoor unit.....	95
6.2.2.1 YUTAKI S	95
6.2.2.2 YUTAKI S COMBI	96
7. Refrigerant cycle and hydraulic circuit.....	97
7.1 Refrigerant cycle and hydraulic circuit for Split system.....	98

7.1.1	Outdoor units	98
7.1.2	Indoor units.....	100
8.	Refrigerant and water piping	103
8.1	General notes before performing piping work	104
8.1.1	Piping work.....	104
8.1.2	Suspension of refrigerant and water pipes.....	104
8.2	R32 refrigerant circuit.....	105
8.2.1	General notes R32 refrigerant.....	105
8.2.2	Refrigerant piping	105
8.2.3	Refrigerant charge.....	107
8.2.3.1	Refrigerant charge amount	107
8.2.3.2	Refrigerant charge before shipment (W_0 (kg))	107
8.3	R410A refrigerant circuit.....	107
8.3.1	Refrigerant charge.....	107
8.3.2	Refrigerant piping	107
8.3.3	Refrigerant charge.....	108
8.3.3.1	Refrigerant charge amount	108
8.3.3.2	Refrigerant charge before shipment (W_0 (kg))	108
8.3.4	Precautions in the event of gas refrigerant leaks	108
8.4	Space heating and DHW.....	110
8.4.1	Additional hydraulic necessary elements for space heating.....	110
8.4.2	Additional hydraulic necessary elements for DHW.....	111
8.4.3	Additional hydraulic optional elements (For DHW).....	113
8.4.4	Additional hydraulic necessary elements for DHW (only for UK market)	113
8.4.5	Requirements and recommendations for the hydraulic circuit	114
8.4.6	Water piping	115
8.4.7	Water quality.....	116
9.	Electrical and control settings.....	117
9.1	General check	118
9.1.1	Split system - Outdoor unit.....	118
9.1.2	Split system - Indoor unit.....	118
9.2	System wiring diagram	120
9.3	Electrical connection	121
9.3.1	Wiring size.....	121
9.3.2	Minimum requirements of the protection devices.....	122
9.4	Transmission wiring.....	125
9.4.1	YUTAKI units	125
9.5	Optional indoor unit wiring (accessories)	126
9.5.1	Summary of the terminal board connections for YUTAKI units	126
9.6	Setting of DIP switches and RSW switches	132
9.6.1	Outdoor unit.....	132
9.6.1.1	Location of DIP switches and rotary switches.....	132
9.6.1.2	Function of DIP switches and rotary switches.....	132
9.6.1.3	LED indication	135

9.6.2	YUTAKI unit.....	136
9.6.2.1	Location of DIP switches and rotary switches.....	136
9.6.2.2	Function of DIP switches and rotary switches.....	136
9.6.2.3	LED indication.....	139
10.	LCD Controller	141
10.1	General information.....	142
10.2	Display.....	142
10.2.1	Main view	142
10.2.2	Dual view.....	143
10.2.3	Menu display	143
10.3	New features	144
10.3.1	Live view.....	144
10.3.2	Operational data list	145
10.3.3	Lock controller.....	145
10.3.4	Communication status menu.....	145
10.3.5	Serial number	146
10.3.6	Alarm description.....	146
10.3.7	Alarm history.....	146
10.3.8	Pump down procedure	146
10.3.9	DHW tank position.....	147
10.3.10	Water pump operation	147
10.3.11	Electrical Heater limitation	147
10.3.12	Energy consumption data.....	148
10.3.13	Wizard start up	148
10.3.14	Fan coils control	149
10.3.15	Wizard to timer set	151
10.3.16	Weekly timer.....	152
10.3.17	Override function.....	152
10.3.18	Display theme.....	152
11.	Optional functions	153
11.1	Indoor unit	154
11.1.1	Optional functions by DSW setting	154
11.1.2	Optional functions by Unit controller (PC-ARFH2E).....	156
11.1.2.1	Optional functions for Space Heating or Space Cooling	156
11.1.2.2	Optional functions for DHW.....	156
11.1.2.3	Optional functions for Heat pump.....	157
11.1.2.4	Optional functions for Unit controller (PC-ARFH2E)	158
11.1.3	Optional external input/output configuration signals.....	158
11.2	Additional functions by accessory sensor	161
11.3	Change of defrost condition	162
11.4	Output/input signals for outdoor units.....	163
12.	Complementary system CASCADE CONTROLLER.....	165
12.1	Main features.....	166
12.1.1	Multi configurations	166

12.1.2	Installation benefits.....	167
12.1.3	Maintenance benefits	169
12.1.4	Control features.....	169
12.1.5	CASCADE control	171
12.1.6	Rotary token control	172
12.1.7	Synchronized defrost.....	173
12.2	General data.....	173
12.3	Electrical data.....	173
12.4	Name of parts.....	174
12.5	Service space.....	175
12.6	Electrical wiring	176
12.7	Transmission wiring.....	177
12.7.3	Summary of the terminal board connections for YUTAKI CASCADE CONTROLLER.....	179
12.7.4	Location of DIP switches and rotary switches	180
12.7.4.1	Function of DIP switches and rotary switches.....	181
12.7.4.2	LED indication.....	184
12.8	Optional functions.....	185
12.8.1	Optional functions by DSW setting.....	185
12.8.2	Optional functions by Unit controller (PC-ARFH2E).....	186
12.8.2.1	Optional functions for Space Heating or Space Cooling.....	186
12.8.2.2	Optional functions for DHW.....	186
12.8.2.3	Optional functions for Heat pump.....	187
12.8.2.4	Optional functions for Unit controller (PC-ARFH2E)	188
12.8.3	Optional external input/output configuration signals.....	188
12.9	Additional functions by accessory sensor	190

1 . General information

Index

1.1	General information.....	2
1.1.1	General notes.....	2
1.1.2	Introduction.....	2
1.1.2.1	Overview of YUTAKI system.....	2
1.1.2.2	Summary of operations.....	3
1.2	Applied symbols.....	4
1.3	Norms and Regulations.....	4
1.4	Product guide.....	5
1.4.1	Classification of the units.....	5
1.4.1.1	Split system - Outdoor unit.....	5
1.4.1.2	Split system - Indoor unit.....	5
1.4.2	Product guide.....	6
1.4.2.1	Split system - Outdoor unit.....	6
1.4.2.2	Split system - Indoor unit.....	6
1.4.3	Accessory code list.....	9
1.4.4	Outdoor unit accessories code list.....	12

1.1 General information

1.1.1 General notes

© Copyright 2021 Johnson Controls-Hitachi Air Conditioning Spain, S.A.U. – All rights reserved.

No part of this publication may be reproduced, copied, filed or transmitted in any shape or form without the permission of Johnson Controls-Hitachi Air Conditioning Spain, S.A.U.

Within the policy of continuous improvement of its products, Johnson Controls-Hitachi Air Conditioning Spain, S.A.U. reserves the right to make changes at any time without prior notification and without being compelled to introducing them into previously sold products. This document may therefore have been subject to amendments during the life of the product.

Hitachi makes every effort to offer correct, up-to-date documentation. Despite this, printing errors cannot be controlled by Hitachi and are not its responsibility.

As a result, some of the images or data used to illustrate this document may not refer to specific models. No claims will be accepted based on the data, illustrations and descriptions included in this manual.

No type of modification must be made to the equipment without prior, written authorization from the manufacturer.



NOTE

This air conditioner has been designed for standard air conditioning for human beings. For use in other applications, please contact your Hitachi dealer or service contractor.

1.1.2 Introduction

Hitachi proudly announces the newest air-to-water heat pumps in its award-winning YUTAKI range.

YUTAKI units produce heating and domestic hot water like any oil or gas boiler, but transforming renewable energy from the outside air into heat. Air to water heat pumps extract the free energy present in the air, which is enough to heat a home up to a comfortable temperature, even on the coldest winter day. Every kW of electricity used to power the heat pump can yield up to more than 5 kW of energy for heating; this provides savings of up to 80% on heating expenses compared to a traditional fossil fuel boiler.

The new YUTAKI series, based on state-of-the-art technology, does not only achieve an outstanding performance in space heating but also provides domestic hot water with high efficiency. Additionally, cooling operation for summer can also be provided installing the dedicated "Cooling kit" accessory of Hitachi.

The system is simple to control; its new user controller (PC-ARFH2E) improves the acclaimed and successful design used with the existing LCD controller and provides a great deal of new functions like: live view, energy consumption data, fan coils control, weekly timer, wizard to set timer, override function, etc.

1.1.2.1 Overview of YUTAKI system

◆ Split system - YUTAKI S, YUTAKI S COMBI

It consists of one outdoor unit and one indoor unit. The outdoor unit extracts the heat present in the air, increases its refrigerant temperature and transmits it to the water circuit using the plate heat exchanger of the indoor unit, where the heat is taken to radiators (fan-coils), underfloor heating components or both (2nd temperature area).

Two types of indoor unit can be used in heating split systems:

YUTAKI S

The indoor unit of YUTAKI S is designed for space heating, in wall-mounted installation. It is convenient for new installations with low capacity requirements (Well insulated installations, high efficiency radiators...).

YUTAKI S COMBI

The indoor unit of YUTAKI S COMBI is conceived as a floor standing unit. It is prepared for heating operation as well as for domestic hot water production. For this purpose, it has a built-in domestic hot water 220 L tank. In line with YUTAKI S units, it meets the needs of installations with low capacity requirements.

Furthermore, new YUTAKI S COMBI models have been designed for the UK market that meet the UK requirements referred in the UK Building Regulations.

1.1.2.2 Summary of operations

Space heating

YUTAKI units are factory-supplied ready for space heating operation. Different heating installation configurations can be selected, providing a comfortable atmosphere all year long, even in the coldest climates:

- **Mono-valent system**
The air to water heat pump is sized to provide 100% of the heating requirements on the coldest day the year.
- **Mono-energy system**
This is the most popular configuration. The air to water heat pump is sized to provide 80% of the heating requirements on the coldest days of the year. An auxiliary electric heater is used to provide the additional heating required on cold days. This option usually results in an ideal balance between installation costs and future energy consumption, as proven by its popularity in colder climates than ours, such as Sweden and Norway.
- **Alternating Bi-valent system**
For installations with an existing heating system by boiler and when is needed to heat the supplied water temperature to the circuit up to high temperatures (80°C), the boiler can be configured to alternate with the air to water heat pump.

Selecting the different configuration types it is possible to adapt the system to all customer requirements, providing a wide application range from the simplest configuration to complete configuration: Radiator, heating floor or both (2nd temperature area).

Domestic hot water production

For YUTAKI S, the Hitachi accessory “DHWT-(200/300)S-3.0H2E” can be used for the production of DHW.

In case of YUTAKI S COMBI, the domestic hot water tank is built in the indoor unit.

An electric heater is incorporated inside both remote and integrated tanks in order to allow an immediate heating of the domestic hot water in accordance with the user’s needs.

Space cooling

YUTAKI units can also be operated in cooling operation. The dedicated “Cooling kit” accessory has been designed for this purpose. Combining the heating only models with these cooling kits, the reversible models become available. In this case, combination with fan-coils, refreshing floor or both (2nd temperature area) can be applied.

Combination with solar panels

YUTAKI system can be combined with solar panel. The solar combination enables to heat up the DHW by means of the sun. The solar combination is designed to transfer the heat from the solar panels (sun radiation) to the heat exchanger of DHW tank.

Swimming pool water heating operation

For summer session period, YUTAKI system can be used to heat up the water temperature of swimming pools up to a value between 24 and 33°C.

1.2 Applied symbols

During normal air conditioning system design work or unit installation, greater attention must be paid in certain situations requiring particular care in order to avoid damage to the unit, the installation or the building or property.

Situations that pose a risk to the safety of those in the surrounding area or to the unit itself are clearly indicated in this manual.

A series of special symbols are used to clearly identify these situations.

Pay close attention to these symbols and to the messages following them, as your safety and that of others depends on it.

DANGER

- *The text following this symbol contains information and instructions relating directly to your safety.*
- *Not taking these instructions into account could lead to serious, very serious or even fatal injuries to you and others.*

In the texts following the danger symbol you can also find information on safety procedures during unit installation.

CAUTION

- *The text following this symbol contains information and instructions relating directly to your safety.*
- *Not taking these instructions into account could lead to minor injuries to you and others.*
- *Not taking these instructions into account could lead to unit damage.*

In the texts following the caution symbol you can also find information on safety procedures during unit installation.

NOTE

- *The text following this symbol contains information or instructions that may be of use or that require a more thorough explanation.*
- *Instructions regarding inspections to be made on unit parts or systems may also be included.*

1.3 Norms and Regulations

Following Regulation EU No. 517/2014 on Certain Fluorinated Greenhouse gases, it is mandatory to fill in the label attached to the unit with the total amount of refrigerant charged on the installation.

Do not vent R32 / R410A into the atmosphere: R32 / R410A are fluorinated greenhouse gases covered by the Kyoto protocol global warming potential (GWP) R32 = 675 / R410A = 2088.

Tn of CO₂ equivalent of fluorinated greenhouse gases contained is calculated by indicated GWP * Total Charge (in kg indicated in the product label and divided by 1000.

Appropriate refrigerant

The refrigerant used in each unit is identified on the specification label and manuals of the unit. Hitachi shall not be held liable for any failure, trouble, malfunction or accident caused by units illegally charged with refrigerants other than the specified one.

Consequences of charging non-specified refrigerant

It may cause mechanical failure, malfunction and other accidents. It may cause operational failure of protection and safety devices of air conditioners. It may also cause lubrication failure of the sliding part of the compressor due to deterioration of refrigerant oil.

In particular, hydrocarbon refrigerants (such as propane, R441A, R443A, GF-08, etc.) are not allowed, since these are combustible and may cause major accidents such as fire and explosion in case of improper handling.

Once a non-specified refrigerant has been charged, no further servicing (including draining of refrigerant) shall be performed, even in case of malfunction. Improper handling of refrigerant may be a cause of fire and explosion, and servicing in such cases may be considered an illegal act.

End clients and costumers shall be informed that servicing is not approved, and the installer who charged the nonspecified refrigerant shall be asked to fix the unit.

Hitachi will accept no responsibility for units that have been charged with non-specified refrigerant once.

1.4 Product guide

1.4.1 Classification of the units

1.4.1.1 Split system - Outdoor unit

Unit type: Outdoor unit (Split air system)										
Position-separating hyphen (fixed)										
Compressor power (HP): 2, 2.5, 3, 4, 5, 6, 8, 10										
For water combination										
Heat pump										
V: Single phase unit (1~ 230V 50Hz)										
—: Three phase unit (3N~ 400V 50Hz)										
N: R410A refrigerant										
R: R32 refrigerant										
Premium series										
Serie 1										
Made in Europe										
RAS	-	X	W	H	(V)	(X)	P	(1)	(E)	

1.4.1.2 Split system - Indoor unit

◆ YUTAKI S

Unit type: YUTAKI S (Split system - Single water module (Indoor unit) - Medium/Low temperature)										
Position-separating hyphen (fixed)										
Compressor power of the combined outdoor unit (HP): 2.0, 2.5, 3.0, 4.0, 5.0, 6.0, 8.0, 10.0										
N: R410A refrigerant										
R: R32 refrigerant										
Serie 1										
Made in Europe										
RWM	-	X.X	(X)		1		E			

◆ YUTAKI S COMBI



Unit type: YUTAKI S COMBI (Split system - Dual water module (Indoor unit + Domestic hot water tank) - Medium/Low temperature)

Position-separating hyphen (fixed)										
Compressor power of the combined outdoor unit (HP): 2.0, 2.5, 3.0, 4.0, 5.0, 6.0										
N: R410A refrigerant										
R: R32 refrigerant										
Water-to-water DHW heat exchanger										
Serie 1										
Made in Europe										
Position-separating hyphen (fixed)										
Tank model: 220 L										
Tank material: Stainless steel										
-K: Model for UK market										
RWD	-	X.X	(X)	W	1	E	-	220	S	(-K)

1.4.2 Product guide

1.4.2.1 Split system - Outdoor unit

1~ 230V 50Hz			
Unit	Code	Unit	Code
RAS-2WHVRP1	60289258	RAS-4WHVNPE	7E350007
RAS-2.5WHVRP1	60289259	RAS-5WHVNPE	7E350008
RAS-3WHVRP1	60289260	RAS-6WHVNPE	7E350009

3N~ 400V 50Hz	
Unit	Code
RAS-4WHNPE	7E350107
RAS-5WHNPE	7E350108
RAS-6WHNPE	7E350109
RAS-8WHNPE	7E350110
RAS-10WHNPE	7E350111









1.4.2.2 Split system - Indoor unit

◆ YUTAKI S

i NOTE

Icons between brackets mean possible extra operations to the factory-supplied operations. For cooling operation, refer to the Cooling kit accessory for YUTAKI S units.

     			
1~ 230V 50Hz			
Unit	Code	Unit	Code
RWM-2.0R1E	7E475216	RWM-4.0N1E	7E475020
RWM-2.0R1E	7E475217	RWM-5.0N1E	7E475021
RWM-3.0R1E	7E475218	RWM-6.0N1E	7E475022

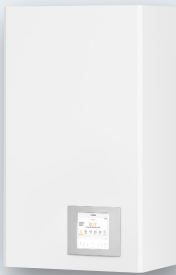
					
3N~ 400V 50Hz					
Unit	Code	Unit	Code	Unit	Code
RWM-2.0R1E	7E475216	RWM-4.0N1E	7E475020	RWM-8.0N1E	7E475023
RWM-2.0R1E	7E475217	RWM-5.0N1E	7E475021	RWM-10.0N1E	7E475024
RWM-3.0R1E	7E475218	RWM-6.0N1E	7E475022		

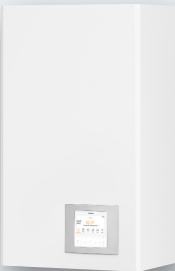
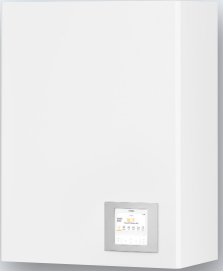

◆ YUTAKI S COMBI

 NOTE





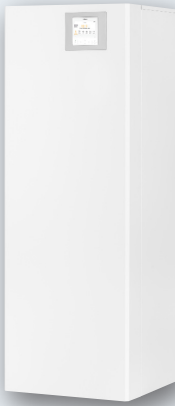

Icons between brackets mean possible extra operations to the factory-supplied operations. For cooling operation, refer to the Cooling kit accessory for YUTAKI S COMBI units.

Standard model

	
1~ 230V 50Hz 3N~ 400V 50Hz	
Unit	Code
RWD-2.0RW1E-220S	7E483503
RWD-2.5RW1E-220S	7E483504
RWD-3.0RW1E-220S	7E483505
RWD-4.0NW1E-220S	7E483507
RWD-5.0NW1E-220S	7E483508
RWD-6.0NW1E-220S	7E483509



Model for UK market

      	
1~ 230V 50Hz 3N~ 400V 50Hz	
Unit	Code
RWD-2.0RW1E-220S-K	7E483516
RWD-2.5RW1E-220S-K	7E483517
RWD-3.0RW1E-220S-K	7E483518
RWD-4.0NW1E-220S-K	7E483520
RWD-5.0NW1E-220S-K	7E483521
RWD-6.0NW1E-220S-K	7E483522



1.4.3 Accessory code list

Model	Ref.
For YUTAKI S units (RWM-(2.0-10.0)(N/R)1E)	S
For YUTAKI S COMBI units (RWD-(2.0-6.0)(N/R)W1E-220S(-K))	SC

◆ Cooling kit accessories



Accessory	Ref.	Name	Code	Figure
ATW-CKS-01	S	Cooling operation kit for YUTAKI S (For 2.0-3.0HP)	7E549927	
ATW-CKS-02	S	Cooling operation kit for YUTAKI S (For 4.0-6.0HP)	7E549928	
ATW-CKS-03	S	Cooling operation kit for YUTAKI S (For 8.0-10.0HP)	7E549929	
NEW ATW-CKSC-02	SC	Cooling operation kit for YUTAKI S COMBI - Insulations + Jumper	7E549959	
NEW ATW-CKSC-03	SC	Cooling operation kit for YUTAKI S COMBI - Insulations + Jumper + Drain Pump	7E549960	

◆ Control accessories

Accessory	Ref.	Name	Code	Figure
NEW PC-ARFH2E	S SC	Unit controller Wired room thermostat	7E543016	
ATW-RTU-04	S SC	Wireless ON/OFF thermostat (Receiver + Room thermostat)	7E543003	
ATW-RTU-06	S SC	Wireless Intelligent thermostat for 2nd circuit (Only Room thermostat. For Intelligent thermostat application)	7E543005	
ATW-RTU-07	S SC	Wireless Intelligent thermostat (Receiver + Room thermostat)	7E543015	

Accessory	Ref.	Name	Code	Figure
AHP-SMB-01	S SC	SmartBox (Hi-Box)	70549919	
ATW-KNX-02	S SC	KNX interface for YUTAKI units	7E549925	
ATW-TAG-02	S SC	Home automation gateway for YUTAKI units	70549926	
ATW-AOS-02	S SC	Auxiliary output signal box (Relay board for additional output signals)	7E549935	
HC-A16MB	S SC	MODBUS gateway for multi YUTAKI systems (up to 8 YUTAKI units max., with or without CASCADE CONTROLLER)	7E513210	
ATW-MBS-02	S SC	MODBUS gateway for single YUTAKI system	7E549924	
 ATW-YCC-03	S SC	YUTAKI CASCADE CONTROLLER (New controller generation (26 languages))	7E549963	

◆ Temperature sensor accessories



Accessory	Ref.	Name	Code	Figure
ATW-2OS-02	S SC	2nd outdoor temperature sensor	9E500017	
ATW-ITS-01	S SC	Indoor wired room temperature sensor	7E549932	
ATW-WTS-02Y	S SC	Universal water temperature sensor	9E500004	

◆ Water circuit accessories

Accessory	Ref.	Name	Code	Figure
ATW-HSK-01	S SC	Hydraulic separator	7E549905	
NEW ATW-CP-05	SC	Active Anode (Impressed current)	7E549954	
ATW-2TK-07	S SC	2nd temperature kit (Wall mounted model)	7E549952	
NEW ATW-2TK-08	SC	2nd temperature kit (Integrable in YUTAKI S COMBI 220 L model)	7E549965	
DHWT-200S-3.0H2E	S	Domestic hot water tank (200 L)	70544002	
DHWT-300S-3.0H2E		Domestic hot water tank (300 L)	70544003	
ATW-AQT-01	S SC	Aquastat security	7E549907	
ATW-3WV-01	S SC	3-way valve (Internal thread and spring return)	7E549906	
ATW-WCV-01	S SC	Water check valve	9E500014	
ATW-DPOV-01	S SC	Differential pressure overflow valve	7E549916	

1.4.4 Outdoor unit accessories code list

Model	Ref.
RAS-(2.0-3.0)WHVRP1	A
RAS-(4.0-10.0)WH(V)NPE	B

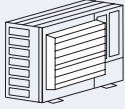
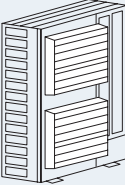
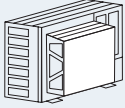
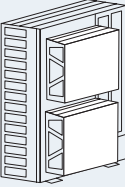
Accessory	OU reference	Description	Code	Figure
DH-SP63A	A	Drain heater	60292335	-
DBS-12L	A	Drain discharge connection	60291491	
DBS-26	B		60299192	
AG-264	A	Air flow guide	60209100	
AG-335A	B		60291432	
WSP-264	A	Wind guard	60291831	
WSP-160A	B		60291753	

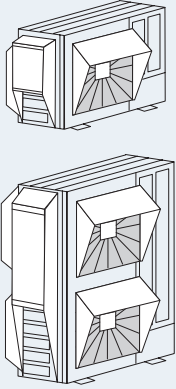
Snow protection hood					
Accessory	OU reference	Description	Code	Figure	
ZINC PLATE					
ASG-SP10FTB (Half)	A	Air outlet	60292336		
ASG-SP11FTB (Full)			60292339		
ASG-NP335F1 (Half)	B		60291771		
ASG-SP11FC (Full)			60291783		
ASG-SP10BTB	A	Air inlet of rear side	60292337		
ASG-NP160B (Half)	B		60291777		
ASG-SP11BA (Full)			60291785		
ASG-SP10LTB	A	Air inlet of side face	60292338		
ASG-NP160L (Half)	B		60291779		
ASG-SP11LA (Full)			60291787		
STAINLESS PLATE					
ASG-SP10FTBS (Half)	A	Air outlet	60292352		
ASG-SP11FTBS (Full)			60292355		
ASG-NP335FS4 (Half)	B		60291940		
ASG-SP11FCS2 (Full)			60291948		
ASG-SP10BTBS (Half)	A	Air inlet of rear side	60292353		
ASG-NP280BS4 (Half)	B		60291945		
ASG-SP11BAS2 (Full)			60291949		
ASG-SP10LTBS (Half)	A	Air inlet of side face	60292354		
ASG-NP280LS4 (Half)	B		60291946		
ASG-SP11LAS2 (Full)			60291950		

2. General data

Index

2.1	Capacity tables.....	16
2.2	ERP performance data (Preliminary data)	19
	2.2.2.2 ERP data - YUTAKI S COMBI.....	25
	2.2.2.3 ERP additional data - YUTAKI S	30
	2.2.2.4 ERP additional data - YUTAKI S COMBI	31
2.2.3	General ERP data for combi heaters	32
	2.2.3.1 YUTAKI S COMBI	32
	2.2.3.2 General ERP data for hot water storage tanks (YUTAKI S).....	33
2.3	Cooling mode application (EN 14825) (Models with cooling kit accessory) (Preliminary data)	34
	2.3.1 Cooling data (EN 14825) - YUTAKI S.....	34
	2.3.2 Cooling data (EN 14825) - YUTAKI S COMBI.....	38
	2.3.3 Additional Cooling data (EN 14825) - YUTAKI S.....	40
	2.3.4 Additional Cooling data (EN 14825) - YUTAKI S COMBI	42
2.4	General specifications	43
	2.4.2 Split system - Outdoor unit (Preliminary data).....	43
	2.4.4 Domestic Hot Water Tank.....	50
2.5	Component data (Preliminary data)	51
	2.5.1 Split system - Outdoor unit	51
	2.5.2 Split system - Indoor unit.....	53
	2.5.2.1 YUTAKI S	53
	2.5.2.2 YUTAKI S COMBI	54
2.6	Electrical data	56
	2.6.2 Split system - Outdoor unit	56
	2.6.3 Split system - Indoor unit.....	57
	2.6.3.1 YUTAKI S	57
	2.6.3.2 YUTAKI S COMBI	58

2.1 Capacity tables

2.1.1 Nominal capacity-performance tables (Preliminary data)

2.1.1.1 Considerations

- The heating capacity tables show the capacity and performance data in integrated values (with defrost correction factor included).
- The nominal heating and cooling capacities are based on the EN 14511 standard: Piping length: 7.5 meters; Piping lift: 0 meters.

Keywords:

- CAP: Nominal capacity (kW)
- COP: Coefficient of performance
- EER: Energy efficiency ratio
- DB: Dry bulb; WB: Wet bulb (°C)
- OAT: Outdoor ambient temperature (°C)
- WIT: Water inlet temperature (°C)
- WOT: Water outlet temperature (°C)

2.1.1.2 Capacity-performance data

Preliminary Performance Subject to Change

◆ YUTAKI S

HP				2.0 HP	2.5 HP	3.0 HP
Outdoor unit model				RAS-2WHVRP1	RAS-2.5WHVRP1	RAS-3WHVRP1
Indoor unit model				RWM-2.0R1E	RWM-2.5R1E	RWM-3.0R1E
OAT (DB/WB)	WIT / WOT	-	Unit	Heating operation		
7 / 6 °C	30 / 35 °C	CAP (Min./Nom./Max.)	kW	1.85 / 4.30 / 6.50	1.8 / 6.00 / 8.0	2.1 / 8.00 / 11.0
		COP (Nom.)	-	5.25	4.80	4.60
	47 / 55 °C	CAP (Nom./Max.)	kW	4.30 / 6.00	6.00 / 7.50	8.00 / 9.50
		COP (Nom.)	-	3.00	2.85	2.80
-7 / -8 °C	30 / 35 °C	CAP (Nom./Max.)	kW	4.50 / 5.30	5.30 / 6.20	5.80 / 7.50
		COP (Nom.)	-	2.8	2.70	2.70
	47 / 55 °C	CAP (Nom./Max.)	kW	4.00 / 4.20	4.7 / 5.00	5.00 / 5.50
		COP (Nom.)	-	2.00	1.80	1.75

OAT (DB/WB)	WIT / WOT	-	Unit	Cooling operation (Using cooling kit accessory)		
35 / -- °C	12 / 7 °C	CAP (Nom./Max.)	kW	4.00 / 5.00	5.30 / 6.00	6.50 / 7.00
		EER (Nom.)	-	4.00	3.60	3.35
	23 / 18 °C	CAP (Nom./Max.)	kW	5.50 / 6.40	6.30 / 7.70	7.00 / 9.00
		EER (Nom.)	-	5.40	5.30	5.00

HP				4.0 HP	5.0 HP	6.0 HP	8.0 HP	10.0 HP
Outdoor unit model				RAS-4WH(V) NPE	RAS-5WH(V) NPE	RAS-6WH(V) NPE	RAS- 8WHNPE	RAS- 10WHNPE
Indoor unit model				RWM-4.0N1E	RWM-5.0N1E	RWM-6.0N1E	RWM-8.0N1E	RWM-10.0N1E
OAT (DB/WB)	WIT / WOT	-	Unit	Heating operation				
7 / 6 °C	30 / 35 °C	CAP (Min./Nom./Max.)	kW	4.3 / 11.0 / 15.2	4.8 / 14.0 / 16.7	5.5 / 16.0 / 17.8	9.0 / 20.0 / 25.5	10.0 / 24.0 / 32.0
		COP (Nom.)	-	5.00	4.71	4.57	4.30	4.29
	47 / 55 °C	CAP (Nom./Max.)	kW	11.0 / 13.5	14.0 / 15.2	16.0 / 17.0	20.0 / 24.0	24.0 / 32.0
		COP (Nom.)	-	3.00	2.80	2.50	2.72	2.65
-7 / -8 °C	30 / 35 °C	CAP (Nom./Max.)	kW	9.7 / 10.6	11.5 / 12.0	12.0 / 13.0	14.2 / 17.9	16.5 / 21.0
		COP (Nom.)	-	2.74	2.65	2.57	2.57	2.46
	47 / 55 °C	CAP (Nom./Max.)	kW	8.7 / 9.7	9.7 / 11.2	10.5 / 12.0	12.5 / 14.5	15.5 / 17.3
		COP (Nom.)	-	1.78	1.85	1.75	1.70	1.50

OAT (DB/WB)	WIT / WOT	-	Unit	Cooling operation (Using cooling kit accessory)				
35 / -- °C	12 / 7 °C	CAP (Nom./Max.)	kW	7.2 / 11.8	9.5 / 12.6	10.5 / 13.7	14.0 / 16.4	17.5 / 20.6
		EER (Nom.)	-	3.54	3.54	3.31	3.12	2.81
	23 / 18 °C	CAP (Nom./Max.)	kW	10.4 / 15.0	12.9 / 16.0	13.5 / 17.5	17.0 / 23.5	20.0 / 27.0
		EER (Nom.)	-	4.50	4.02	3.81	3.81	3.61

◆ YUTAKI S COMBI

HP				2.0 HP	2.5 HP	3.0 HP
Outdoor unit model				RAS-2WHVRP1	RAS-2.5WHVRP1	RAS-3WHVRP1
Indoor unit model				RWD-2.0RW1E- 220S(-K)	RWD-2.5RW1E- 220S(-K)	RWD-3.0RW1E- 220S(-K)
OAT (DB/WB)	WIT / WOT	-	Unit	Heating operation		
7 / 6 °C	30 / 35 °C	CAP (Min./Nom./Max.)	kW	1.85 / 4.30 / 6.50	1.8 / 6.00 / 8.60	2.1 / 8.00 / 11.0
		COP (Nom.)	-	5.25	4.80	4.60
	47 / 55 °C	CAP (Nom./Max.)	kW	4.30 / 6.00	6.00 / 7.50	8.00 / 9.50
		COP (Nom.)	-	3.00	2.85	2.80
-7 / -8 °C	30 / 35 °C	CAP (Nom./Max.)	kW	4.50 / 5.30	5.30 / 6.20	5.80 / 7.50
		COP (Nom.)	-	2.8	2.70	2.70
	47 / 55 °C	CAP (Nom./Max.)	kW	4.00 / 4.20	4.7 / 5.00	5.00 / 5.50
		COP (Nom.)	-	2.00	1.80	1.75
OAT (DB/WB)	WIT / WOT	-	Unit	Cooling operation (Using cooling kit accessory)		
35 / -- °C	12 / 7 °C	CAP (Nom./Max.)	kW	4.00 / 5.00	5.30 / 6.00	7.2 / 11.8
		EER (Nom.)	-	4.00	3.60	3.54
	23 / 18 °C	CAP (Nom./Max.)	kW	5.50 / 6.40	6.30 / 7.70	10.4 / 15.0
		EER (Nom.)	-	5.40	5.30	4.50

HP				4.0 HP	5.0 HP	6.0 HP
Outdoor unit model				RAS-4WH(V)NPE	RAS-5WH(V)NPE	RAS-6WH(V)NPE
Indoor unit model				RWD-4.0NW1E-220S(-K)	RWD-5.0NW1E-220S(-K)	RWD-6.0NW1E-220S(-K)
OAT (DB/WB)	WIT / WOT	-	Unit	Heating operation		
7 / 6 °C	30 / 35 °C	CAP (Min./Nom./Max.)	kW	4.3 / 11.0 / 15.2	4.8 / 14.0 / 16.7	5.5 / 16.0 / 17.8
		COP (Nom.)	-	5.00	4.71	4.57
	47 / 55 °C	CAP (Nom./Max.)	kW	11.0 / 13.5	14.0 / 15.2	16.0 / 17.0
		COP (Nom.)	-	3.00	2.80	2.50
-7 / -8 °C	30 / 35 °C	CAP (Nom./Max.)	kW	9.7 / 10.6	11.5 / 12.0	12.0 / 13.0
		COP (Nom.)	-	2.74	2.65	2.57
	47 / 55 °C	CAP (Nom./Max.)	kW	8.7 / 9.7	9.7 / 11.2	10.5 / 12.0
		COP (Nom.)	-	1.78	1.85	1.75
OAT (DB/WB)	WIT / WOT	-	Unit	Cooling operation (Using cooling kit accessory)		
35 / -- °C	12 / 7 °C	CAP (Nom./Max.)	kW	9.5 / 12.6	10.5 / 13.7	7.2 / 11.8
		EER (Nom.)	-	3.54	3.31	3.54
	23 / 18 °C	CAP (Nom./Max.)	kW	12.9 / 16.0	13.5 / 17.5	10.4 / 15.0
		EER (Nom.)	-	4.02	3.81	4.50

◆ YUTAKI S COMBI Domestic Hot Water tank performance

HP				(2.0-3.0) HP	(4.0-6.0) HP
Tank	Outdoor unit model			RAS-(2-3)WHVRP1	RAS-(4-6)WH(V)NPE
	Indoor unit model			RWD-(2.0-3.0)RW1E-220S(-K)	RWD-(4.0-6.0)NW1E-220S(-K)
220 L	Load profile	-	-	L	L
	COP _{dhw}	-	-	3.2	3.1
	Heating up time	t _h	h:min	1:55	1:05
	Standby power input	Pes	W	30	34
	Mixed water at 40 °C	Vmax	L	288	288
	Ref hot water temperature	θ'wh	°C	52.85	52.85
	Efficiency	ηwh	%	130	127
	Energy class	-	-	A+	A+

2.2 ERP performance data (Preliminary data)

2.2.1 General considerations

- This appliance must be installed, maintained and dismantled by professionals. Do not pour contained refrigerant into the atmosphere since this refrigerant fluid is a fluorinated greenhouse gas regulated under European Regulation (EU) No 517/2014.
- Data between brackets corresponds only to heating and cooling models ("Cooling kit" accessory needed).
- Data with the mark (*) corresponds to the "Energy efficiency contribution (η_s)" due to the use of temperature control.

OTC control (Factory-supplied)		Wired room thermostat (PC-ARFH2E)		7E543016	
		Wireless room thermostat (ATW-RTU-04)		7E543003	
		Wired room sensor (ATW-ITS-01)		7E549932	
Temperature control class	II	Temperature control class		VI	
Energy efficiency contribution	+2%	Contribution to the nominal energy efficiency		+4%	

2.2.2 General ERP data for space heaters

2.2.2.1 ERP data - YUTAKI S

◆ AVERAGE climate

RAS-(2-3)WHVRP1 + RWM-(2.0-3.0)R1E

Model		HP		2.0 HP		2.5 HP		3.0 HP	
		Outdoor unit		RAS-2WHVRP1		RAS-2.5WHVRP1		RAS-3WHVRP1	
		Indoor unit		RWM-2.0R1E		RWM-2.5R1E		RWM-3.0R1E	
Water outlet temperature				35°C	55°C	35°C	55°C	35°C	55°C
Product description	Air to water heat pump	-		Yes					
	Heat pump combination heater	-		No					
	Low temperature heat pump	-		No					
	Complementary heater	-		Yes					
Design capacity (P_{DESIGN})		kW	4.0	4.0	6.0	5.0	7.0	6.0	
Nominal energy efficiency (η_s)		%	181 (186)	130 (132)	177 (180)	127 (128)	177 (179)	125 (126)	
Nominal energy class		-	A+++	A++	A+++	A++	A+++	A++	
Data for Packaged Fiche:									
Energy efficiency with OTC control (η_s) (*)		%	183 (188)	135 (138)	179 (182)	129 (130)	179 (181)	127 (129)	
Energy class with OTC control		-	A+++	A++	A+++	A++	A+++	A++	
Energy efficiency with thermostats/sensors (η_s) (*)		%	185 (190)	137 (140)	181 (184)	131 (132)	181 (183)	129 (131)	
Energy class with thermostats		-	A+++	A++	A+++	A++	A+++	A++	
Supplementary capacity (P_{SUP})		kW	0.0	0.9	0.25	1.1	0.6	1.5	
Type of energy used		-	Electricity						
Declared capacity (Pdh) and coefficient of performance (COP _d) at partial load under the following outdoor temperatures:									
Outdoor temperature (T _j) = -7°C	Pdh	kW	3.54	3.50	5.10	4.42	5.90	5.10	
	COP _d	-	3.20	2.00	2.70	1.85	2.65	1.84	
Outdoor temperature (T _j) = +2°C	Pdh	kW	2.35	2.10	3.10	2.69	3.59	3.10	
	COP _d	-	4.80	3.25	4.60	3.30	4.30	3.10	
Outdoor temperature (T _j) = +7°C	Pdh	kW	3.00	2.43	3.00	2.43	3.20	2.00	
	COP _d	-	6.20	5.20	6.20	4.60	7.00	4.65	
Outdoor temperature (T _j) = +12°C	Pdh	kW	3.05	2.80	3.05	2.80	3.50	2.20	
	COP _d	-	8.30	6.90	8.35	6.35	9.70	6.55	
Outdoor temperature (T _j) = Bivalent temperature (T _{biv})	Pdh	kW	3.54	3.50	5.10	4.42	5.90	5.10	
	COP _d	-	3.20	2.00	2.70	1.85	2.65	1.84	
Outdoor temperature (T _j) = Limit operation temperature (TOL)	Pdh	kW	4.00	3.10	5.30	3.90	5.60	5.00	
	COP _d	-	2.75	1.90	2.50	1.70	2.30	1.50	
Bivalent temperature (T _{biv})		°C	-7	-7	-7	-7	-7	-7	
Limit operation temperature (TOL)		°C	-10	-10	-10	-10	-10	-10	
Water limit operation temperature (WTOL)		°C	55	55	55	55	55	55	
Degradation coefficient (Cdh)		-	0.9	0.9	0.9	0.9	0.9	0.9	
Annual energy consumption (Q _{HE})		kW·h	1798 (1754)	2463 (2420)	2652 (2608)	3186 (3143)	3068 (3024)	3723 (3680)	

RAS-(4-6)WHVNPE + RWM-(4.0-6.0)N1E

Model		HP		4.0 HP		5.0 HP		6.0 HP	
		Outdoor unit		RAS-4WHVNPE		RAS-5WHVNPE		RAS-6WHVNPE	
		Indoor unit		RWM-4.0N1E		RWM-5.0N1E		RWM-6.0N1E	
Water outlet temperature				35°C	55°C	35°C	55°C	35°C	55°C
Product description	Air to water heat pump		-	Yes					
	Heat pump combination heater		-	No					
	Low temperature heat pump		-	No					
	Complementary heater		-	Yes					
Design capacity (P _{DESIGN})			kW	11.0	10.0	14.0	12.0	16.0	14.0
Nominal energy efficiency (η _s)			%	187 (189)	135 (136)	175 (176)	133 (133)	153 (153)	125 (126)
Nominal energy class			-	A+++	A++	A+++	A++	A++	A++
Data for Packaged Fiche:									
Energy efficiency with OTC control (η _s) (*)			%	189 (191)	138 (139)	177 (178)	135 (136)	155 (155)	127 (128)
Energy class with OTC control			-	A+++	A++	A+++	A++	A++	A++
Energy efficiency with thermostats/sensors (η _s) (*)			%	191 (193)	140 (141)	179 (180)	137 (138)	157 (157)	129 (130)
Energy class with thermostats			-	A+++	A++	A+++	A++	A++	A++
Supplementary capacity (P _{SUP})			kW	0.5	2.3	1.9	2.6	1.9	3.1
Type of energy used			-	Electricity					
Declared capacity (P _{dh}) and coefficient of performance (COP _d) at partial load under the following outdoor temperatures:									
Outdoor temperature (T _j) = -7°C	P _{dh}	kW	9.60	8.60	12.00	10.25	13.80	12.00	
	COP _d	-	2.74	1.80	2.55	1.70	2.40	1.60	
Outdoor temperature (T _j) = +2°C	P _{dh}	kW	5.84	5.23	7.30	6.24	8.40	7.30	
	COP _d	-	5.20	3.60	4.70	3.60	3.90	3.35	
Outdoor temperature (T _j) = +7°C	P _{dh}	kW	3.76	3.52	4.70	4.01	5.40	4.70	
	COP _d	-	5.80	4.80	5.70	4.60	5.00	4.35	
Outdoor temperature (T _j) = +12°C	P _{dh}	kW	3.70	3.60	3.50	3.50	3.50	3.60	
	COP _d	-	6.40	5.80	6.00	5.50	6.00	5.50	
Outdoor temperature (T _j) = Bivalent temperature (T _{biv})	P _{dh}	kW	9.60	8.60	12.00	10.25	13.80	12.00	
	COP _d	-	2.74	1.80	2.55	1.70	2.40	1.60	
Outdoor temperature (T _j) = Limit operation temperature (TOL)	P _{dh}	kW	10.50	7.40	12.10	9.00	14.10	10.5	
	COP _d	-	2.65	1.70	2.50	1.60	2.30	1.40	
Bivalent temperature (T _{biv})			°C	-7	-7	-7	-7	-7	-7
Limit operation temperature (TOL)			°C	-10	-10	-10	-10	-10	-10
Water limit operation temperature (WTOL)			°C	55	55	55	55	55	55
Degradation coefficient (C _{dh})			-	0.9	0.9	0.9	0.9	0.9	0.9
Annual energy consumption (Q _{HIE})			kW·h	4714 (4666)	5815 (5767)	6313 (6265)	7066 (7018)	8287 (8239)	8759 (8710)

RAS-(4-6)WHNPE + RWM-(4.0-6.0)N1E

Model		HP	4.0 HP		5.0 HP		6.0 HP	
		Outdoor unit	RAS-4WHNPE		RAS-5WHNPE		RAS-6WHNPE	
		Indoor unit	RWM-4.0N1E		RWM-5.0N1E		RWM-6.0N1E	
Water outlet temperature			35°C	55°C	35°C	55°C	35°C	55°C
Product description	Air to water heat pump	-	Yes					
	Heat pump combination heater	-	No					
	Low temperature heat pump	-	No					
	Complementary heater	-	Yes					
Design capacity (P _{DESIGN})		kW	11.0	10.0	14.0	12.0	16.0	14.0
Nominal energy efficiency (η _s)		%	186 (189)	135 (136)	174 (176)	132 (133)	152 (153)	125 (126)
Nominal energy class		-	A+++	A++	A++ (A+++)	A++	A++	A++
Data for Packaged Fiche:								
Energy efficiency with OTC control (η _s) (*)		%	188 (191)	137 (139)	176 (178)	135 (136)	154 (155)	127 (128)
Energy class with OTC control		-	A+++	A++	A+++	A++	A++	A++
Energy efficiency with thermostats/sensors (η _s) (*)		%	190 (193)	139 (141)	178 (180)	137 (138)	156 (157)	129 (130)
Energy class with thermostats		-	A+++	A++	A+++	A++	A++	A++
Supplementary capacity (P _{SUP})		kW	0.5	2.3	1.9	2.6	1.9	3.1
Type of energy used		-	Electricity					
Declared capacity (P _{dh}) and coefficient of performance (COP _d) at partial load under the following outdoor temperatures:								
Outdoor temperature (T _j) = -7°C	P _{dh}	kW	9.60	8.60	12.00	10.25	13.80	12.00
	COP _d	-	2.74	1.80	2.55	1.70	2.40	1.60
Outdoor temperature (T _j) = +2°C	P _{dh}	kW	5.84	5.23	7.30	6.24	8.40	7.30
	COP _d	-	5.20	3.60	4.70	3.60	3.90	3.35
Outdoor temperature (T _j) = +7°C	P _{dh}	kW	3.76	3.52	4.70	4.01	5.40	4.70
	COP _d	-	5.80	4.80	5.70	4.60	5.00	4.35
Outdoor temperature (T _j) = +12°C	P _{dh}	kW	3.70	3.60	3.50	3.50	3.50	3.60
	COP _d	-	6.40	5.80	6.00	5.50	6.00	5.50
Outdoor temperature (T _j) = Bivalent temperature (T _{biv})	P _{dh}	kW	9.60	8.60	12.00	10.25	13.80	12.00
	COP _d	-	2.74	1.80	2.55	1.70	2.40	1.60
Outdoor temperature (T _j) = Limit operation temperature (TOL)	P _{dh}	kW	10.50	7.40	12.10	9.00	14.10	10.50
	COP _d	-	2.65	1.70	2.50	1.60	2.30	1.40
Bivalent temperature (T _{biv})		°C	-7	-7	-7	-7	-7	-7
Limit operation temperature (TOL)		°C	-10	-10	-10	-10	-10	-10
Water limit operation temperature (WTOL)		°C	55	55	55	55	55	55
Degradation coefficient (C _{dh})		-	0.9	0.9	0.9	0.9	0.9	0.9
Annual energy consumption (Q _{HE})		kW·h	4736 (4666)	5837 (5767)	6335 (6265)	7088 (7018)	8309 (8239)	8781 (8710)

RAS-(8-10)WHNPE + RWM-(8.0-10.0)N1E

Model		HP		8.0 HP		10 HP	
		Outdoor unit		RAS-8WHNPE		RAS-10WHNPE	
		Indoor unit		RWM-8.0N1E		RWM-10.0N1E	
Water outlet temperature				35°C	55°C	35°C	55°C
Product description	Air to water heat pump		-	Yes			
	Heat pump combination heater		-	No			
	Low temperature heat pump		-	No			
	Complementary heater		-	Yes			
Design capacity (P_{DESIGN})			kW	18.0	16.0	20.0	18.0
Nominal energy efficiency (η_S)			%	150 (152)	120 (122)	141 (142)	116 (118)
Nominal energy class			-	A++	A+	A+	A+
Data for Packaged Fiche:							
Energy efficiency with OTC control (η_S) (*)			%	152 (154)	122 (124)	143 (144)	118 (120)
Energy class with OTC control			-	A++	A+	A+	A+
Energy efficiency with thermostats/sensors (η_S) (*)			%	154 (156)	124 (126)	145 (146)	120 (122)
Energy class with thermostats			-	A++	A+ (A++)	A+	A+
Supplementary capacity (P_{SUP})			kW	1.6	3.5	1.7	3.6
Type of energy used			-	Electricity			
Declared capacity (P_{dh}) and coefficient of performance (COP_d) at partial load under the following outdoor temperatures:							
Outdoor temperature (T_j) = -7°C	Pdh	kW	15.60	13.80	17.40	15.60	
	COP_d	-	2.50	1.65	2.30	1.65	
Outdoor temperature (T_j) = +2°C	Pdh	kW	9.50	8.40	10.77	9.50	
	COP_d	-	3.85	3.20	3.60	3.10	
Outdoor temperature (T_j) = +7°C	Pdh	kW	6.10	6.00	8.70	8.30	
	COP_d	-	5.40	4.60	5.10	4.35	
Outdoor temperature (T_j) = +12°C	Pdh	kW	7.00	6.80	8.70	8.50	
	COP_d	-	4.65	4.50	4.90	4.60	
Outdoor temperature (T_j) = Bivalent temperature (T_{biv})	Pdh	kW	15.60	13.80	17.40	15.60	
	COP_d	-	2.50	1.65	2.30	1.65	
Outdoor temperature (T_j) = Limit operation temperature (TOL)	Pdh	kW	16.00	12.10	18.00	14.00	
	COP_d	-	2.40	1.50	2.10	1.45	
Bivalent temperature (T_{biv})			°C	-7	-7	-7	-7
Limit operation temperature (TOL)			°C	-10	-10	-10	-10
Water limit operation temperature (WTOL)			°C	55	55	55	55
Degradation coefficient (Cdh)			-	0.9	0.9	0.9	0.9
Annual energy consumption (Q_{HE})			kW·h	9514 (9382)	10452 (10320)	11324 (11192)	12210 (12078)

◆ **WARMER climate****RAS-(2-3)WHVRP1 + RWM-(2.0-3.0)R1E**

Model	HP		2.0 HP	2.5 HP	3.0 HP
	Outdoor unit		RAS-2WHVRP1	RAS-2.5WHVRP1	RAS-3WHVRP1
	Indoor unit		RWM-2.0R1E	RWM-2.5R1E	RWM-3.0R1E
Design capacity (P_{DESIGN})	kW		4.0	5.0	6.0
⁽¹⁾ Nominal energy efficiency (η_s)	%		185 (194)	182 (189)	170 (175)
Data for Packaged Fiche:					
⁽²⁾ Energy efficiency with OTC control (η_s) (*)	%		187 (196)	184 (191)	172 (177)
⁽³⁾ Energy efficiency with thermostats (η_s) (*)	%		189 (198)	186 (193)	174 (177)
Annual energy consumption (Q_{HE})	kW·h		1137 (1084)	1441 (1389)	1857 (1804)

RAS-(4-6)WH(V)NPE + RWM-(4.0-6.0)N1E

Model	HP		4.0 HP	5.0 HP	6.0 HP
	Outdoor unit		RAS-4WHVNPE	RAS-5WHVNPE	RAS-6WHVNPE
	Indoor unit		RWM-4.0N1E	RWM-5.0N1E	RWM-6.0N1E
Design capacity (P_{DESIGN})	kW		10	12	14
⁽¹⁾ Nominal energy efficiency (η_s)	%		193	183	177
Data for Packaged Fiche:					
⁽²⁾ Energy efficiency with OTC control (η_s) (*)	%		195	185	179
⁽³⁾ Energy efficiency with thermostats (η_s) (*)	%		197	187	181
Annual energy consumption (Q_{HE})	kW·h		2722	3455	4149

Model	HP		4.0 HP	5.0 HP	6.0 HP
	Outdoor unit		RAS-4WHNPE	RAS-5WHNPE	RAS-6WHNPE
	Indoor unit		RWM-4.0N1E	RWM-5.0N1E	RWM-6.0N1E
Design capacity (P_{DESIGN})	kW		10	12	14
⁽¹⁾ Nominal energy efficiency (η_s)	%		191	181	176
Data for Packaged Fiche:					
⁽²⁾ Energy efficiency with OTC control (η_s) (*)	%		193	183	178
⁽³⁾ Energy efficiency with thermostats (η_s) (*)	%		195	185	180
Annual energy consumption (Q_{HE})	kW·h		2748	3481	4175

RAS-(8-10)WHNPE + RWM-(8.0-10.0)N1E

Model	HP		8.0 HP	10.0 HP
	Outdoor unit		RAS-8WHNPE	RAS-10WHNPE
	Indoor unit		RWM-8.0N1E	RWM-10.0N1E
Design capacity (P_{DESIGN})	kW		16	18
⁽¹⁾ Nominal energy efficiency (η_s)	%		178	173
Data for Packaged Fiche:				
⁽²⁾ Energy efficiency with OTC control (η_s) (*)	%		181	178
⁽³⁾ Energy efficiency with thermostats (η_s) (*)	%		183	180
Annual energy consumption (Q_{HE})	kW·h		4725	5466

◆ **COLDER climate****RAS-(2-3)WHVRP1 + RWM-(2.0-3.0)R1E**

Model	HP		2.0 HP	2.5 HP	3.0 HP
	Outdoor unit		RAS-2WHVRP1	RAS-2.5WHVRP1	RAS-3WHVRP1
	Indoor unit		RWM-2.0R1E	RWM-2.5R1E	RWM-3.0R1E
Design capacity (P_{DESIGN})	kW		4.0	5.0	6.0
⁽¹⁾ Nominal energy efficiency (η_s)	%		123 (125)	122 (123)	118 (118)
Data for Packaged Fiche:					
⁽²⁾ Energy efficiency with OTC control (η_s) (*)	%		125 (127)	124 (125)	120 (120)
⁽³⁾ Energy efficiency with thermostats (η_s) (*)	%		127 (129)	126 (127)	122 (122)
Annual energy consumption (Q_{HE})	kW·h		3058 (3031)	4048 (4022)	4910 (4884)

RAS-(4-6)WH(V)NPE + RWM-(4.0-6.0)N1E

Model	HP		4.0 HP	5.0 HP	6.0 HP
	Outdoor unit		RAS-4WHVNP1	RAS-5WHVNP1	RAS-6WHVNP1
	Indoor unit		RWM-4.0N1E	RWM-5.0N1E	RWM-6.0N1E
Design capacity (P_{DESIGN})	kW		11	12	14
⁽¹⁾ Nominal energy efficiency (η_s)	%		120	119	112
Data for Packaged Fiche:					
⁽²⁾ Energy efficiency with OTC control (η_s) (*)	%		122	121	114
⁽³⁾ Energy efficiency with thermostats (η_s) (*)	%		124	123	116
Annual energy consumption (Q_{HE})	kW·h		8641	9514	11620

Model	HP		4.0 HP	5.0 HP	6.0 HP
	Outdoor unit		RAS-4WHNP1	RAS-5WHNP1	RAS-6WHNP1
	Indoor unit		RWM-4.0N1E	RWM-5.0N1E	RWM-6.0N1E
Design capacity (P_{DESIGN})	kW		11	12	14
⁽¹⁾ Nominal energy efficiency (η_s)	%		120	119	112
Data for Packaged Fiche:					
⁽²⁾ Energy efficiency with OTC control (η_s) (*)	%		122	121	114
⁽³⁾ Energy efficiency with thermostats (η_s) (*)	%		124	123	116
Annual energy consumption (Q_{HE})	kW·h		8654	9528	11633

RAS-(8-10)WHNP1 + RWM-(8.0-10.0)N1E

Model	HP		8.0 HP	10.0 HP
	Outdoor unit		RAS-8WHNP1	RAS-10WHNP1
	Indoor unit		RWM-8.0N1E	RWM-10.0N1E
Design capacity (P_{DESIGN})	kW		16	18
⁽¹⁾ Nominal energy efficiency (η_s)	%		109	107
Data for Packaged Fiche:				
⁽²⁾ Energy efficiency with OTC control (η_s) (*)	%		111	109
⁽³⁾ Energy efficiency with thermostats (η_s) (*)	%		113	111
Annual energy consumption (Q_{HE})	kW·h		13987	15956

2.2.2.2 ERP data - YUTAKI S COMBI

◆ AVERAGE climate

RAS-(2-3)WHVRP1 + RWD-(2.0-3.0)RW1E-220S(-K)

Model		HP	2.0 HP		2.5 HP		3.0 HP	
		Outdoor unit	RAS-2WHVRP1		RAS-2.5WHVRP1		RAS-3WHVRP1	
		Indoor unit	RWD-2.0RW1E-220S(-K)		RWD-2.5RW1E-220S(-K)		RWD-3.0RW1E-220S(-K)	
Water outlet temperature			35°C	55°C	35°C	55°C	35°C	55°C
Product description	Air to water heat pump	-	Yes					
	Heat pump combination heater	-	No					
	Low temperature heat pump	-	No					
	Complementary heater	-	Yes					
Design capacity (P _{DESIGN})		kW	4.0	4.0	6.0	5.0	7.0	6.0
Nominal energy efficiency (η _s)		%	181 (186)	130 (132)	177 (180)	127 (128)	177 (179)	125 (126)
Nominal energy class		-	A+++	A++	A+++	A++	A+++	A++
Data for Packaged Fiche:								
Energy efficiency with OTC control (η _s) (*)		%	183 (188)	135 (138)	179 (182)	129 (130)	179 (181)	127 (129)
Energy class with OTC control		-	A+++	A++	A+++	A++	A+++	A++
Energy efficiency with thermostats/sensors (η _s) (*)		%	185 (190)	137 (140)	181 (184)	131 (132)	181 (183)	129 (131)
Energy class with thermostats		-	A+++	A++	A+++	A++	A+++	A++
Supplementary capacity (P _{SUP})		kW	0.0	0.9	0.25	1.1	0.6	1.5
Type of energy used		-	Electricity					
Declared capacity (P _{dh}) and coefficient of performance (COP _d) at partial load under the following outdoor temperatures:								
Outdoor temperature (T _j) = -7°C	P _{dh}	kW	3.54	3.50	5.10	4.42	5.90	5.10
	COP _d	-	3.20	2.00	2.70	1.85	2.65	1.84
Outdoor temperature (T _j) = +2°C	P _{dh}	kW	2.35	2.16	3.10	2.69	3.59	3.10
	COP _d	-	4.80	3.25	4.60	3.30	4.30	3.10
Outdoor temperature (T _j) = +7°C	P _{dh}	kW	3.00	2.43	3.00	2.43	3.20	2.00
	COP _d	-	6.20	5.20	6.20	4.60	7.00	4.65
Outdoor temperature (T _j) = +12°C	P _{dh}	kW	3.05	2.80	3.05	2.80	3.50	2.20
	COP _d	-	8.30	6.90	8.35	6.35	9.70	6.55
Outdoor temperature (T _j) = Bivalent temperature (T _{biv})	P _{dh}	kW	3.54	3.50	5.10	4.42	5.90	5.10
	COP _d	-	3.20	2.00	2.70	1.85	2.65	1.84
Outdoor temperature (T _j) = Limit operation temperature (TOL)	P _{dh}	kW	4.00	3.10	5.30	3.90	5.60	5.00
	COP _d	-	2.75	1.90	2.50	1.70	2.30	1.50
Bivalent temperature (T _{biv})		°C	-7	-7	-7	-7	-7	-7
Limit operation temperature (TOL)		°C	-10	-10	-10	-10	-10	-10
Water limit operation temperature (WTOL)		°C	55	55	55	55	55	55
Degradation coefficient (C _{dh})		-	0.9	0.9	0.9	0.9	0.9	0.9
Annual energy consumption (Q _{HE})		kW·h	1798 (1754)	2463 (2420)	2652 (2608)	3186 (3143)	3068 (3024)	3723 (3680)

RAS-(4-6)WHVNPE + RWD-(4.0-6.0)NW1E-220S(-K)

Model		HP		4.0 HP		5.0 HP		6.0 HP	
		Outdoor unit		RAS-4WHVNPE		RAS-5WHVNPE		RAS-6WHVNPE	
		Indoor unit		RWD-4.0NW1E-220S(-K)		RWD-5.0NW1E-220S(-K)		RWD-6.0NW1E-220S(-K)	
Water outlet temperature				35°C	55°C	35°C	55°C	35°C	55°C
Product description	Air to water heat pump		-		Yes				
	Heat pump combination heater		-		No				
	Low temperature heat pump		-		No				
	Complementary heater		-		Yes				
Design capacity (P_{DESIGN})		kW	11.0	10.0	14.0	12.0	16.0	14.0	
Nominal energy efficiency (η_s)		%	187 (189)	136 (137)	175 (176)	133 (133)	153 (153)	125 (126)	
Nominal energy class		-	A+++	A++	A+++	A++	A++	A++	
Data for Packaged Fiche:									
Energy efficiency with OTC control (η_s) (*)		%	189 (191)	138 (139)	177 (178)	135 (136)	155 (155)	127 (128)	
Energy class with OTC control		-	A+++	A++	A+++	A++	A++	A++	
Energy efficiency with thermostats/sensors (η_s) (*)		%	191 (193)	140 (141)	179 (180)	137 (138)	157 (157)	129 (130)	
Energy class with thermostats		-	A+++	A++	A+++	A++	A++	A++	
Supplementary capacity (P_{SUP})		kW	0.5	2.3	1.9	2.6	1.9	3.1	
Type of energy used		-	Electricity						
Declared capacity (P_{dh}) and coefficient of performance (COP_d) at partial load under the following outdoor temperatures:									
Outdoor temperature (T_j) = -7°C	Pdh	kW	9.60	8.60	12.00	10.25	13.80	12.00	
	COP_d	-	2.74	1.80	2.55	1.70	2.40	1.60	
Outdoor temperature (T_j) = +2°C	Pdh	kW	5.84	5.23	7.30	6.24	8.40	7.30	
	COP_d	-	5.20	3.60	4.70	3.60	3.90	3.35	
Outdoor temperature (T_j) = +7°C	Pdh	kW	3.76	3.52	4.70	4.01	5.40	4.70	
	COP_d	-	5.80	4.80	5.70	4.60	5.00	4.35	
Outdoor temperature (T_j) = +12°C	Pdh	kW	3.70	3.60	3.50	3.50	3.50	3.60	
	COP_d	-	6.40	5.80	6.00	5.50	6.00	5.50	
Outdoor temperature (T_j) = Bivalent temperature (T_{biv})	Pdh	kW	9.60	8.60	12.00	10.25	13.80	12.00	
	COP_d	-	2.74	1.80	2.55	1.70	2.40	1.60	
Outdoor temperature (T_j) = Limit operation temperature (TOL)	Pdh	kW	10.50	7.40	12.10	9.00	14.10	10.5	
	COP_d	-	2.65	1.70	2.50	1.60	2.30	1.40	
Bivalent temperature (T_{biv})		°C	-7	-7	-7	-7	-7	-7	
Limit operation temperature (TOL)		°C	-10	-10	-10	-10	-10	-10	
Water limit operation temperature (WTOL)		°C	55	55	55	55	55	55	
Degradation coefficient (Cdh)		-	0.9	0.9	0.9	0.9	0.9	0.9	
Annual energy consumption (Q_{HE})		kW·h	4714 (4666)	5815 (5767)	6313 (6265)	7066 (7018)	8287 (8239)	8759 (8710)	

RAS-(4-6)WHNPE + RWD-(4.0-6.0)NW1E-220S(-K)

Model		HP	4.0 HP		5.0 HP		6.0 HP	
		Outdoor unit	RAS-4WHNPE		RAS-5WHNPE		RAS-6WHNPE	
		Indoor unit	RWD-4.0NW1E-220S(-K)		RWD-5.0NW1E-220S(-K)		RWD-6.0NW1E-220S(-K)	
Water outlet temperature			35°C	55°C	35°C	55°C	35°C	55°C
Product description	Air to water heat pump	-	Yes					
	Heat pump combination heater	-	No					
	Low temperature heat pump	-	No					
	Complementary heater	-	Yes					
Design capacity (P_{DESIGN})		kW	11.0	10.0	14.0	12.0	16.0	14.0
Nominal energy efficiency (η_s)		%	186 (189)	135 (136)	174 (176)	132 (133)	152 (153)	125 (126)
Nominal energy class		-	A+++	A++	A++ (A+++)	A++	A++	A++
Data for Packaged Fiche:								
Energy efficiency with OTC control (η_s) (*)		%	188 (191)	137 (139)	176 (178)	135 (136)	154 (155)	127 (128)
Energy class with OTC control		-	A+++	A++	A+++	A++	A++	A++
Energy efficiency with thermostats/sensors (η_s) (*)		%	190 (193)	139 (141)	178 (180)	137 (138)	156 (157)	129 (130)
Energy class with thermostats		-	A+++	A++	A+++	A++	A++	A++
Supplementary capacity (P_{SUP})		kW	0.5	2.3	1.9	2.6	1.9	3.1
Type of energy used		-	Electricity					
Declared capacity (P_{dh}) and coefficient of performance (COP_d) at partial load under the following outdoor temperatures:								
Outdoor temperature (T_j) = -7°C	P_{dh}	kW	9.60	8.60	12.00	10.25	13.80	12.00
	COP_d	-	2.74	1.80	2.55	1.70	2.40	1.60
Outdoor temperature (T_j) = +2°C	P_{dh}	kW	5.84	5.23	7.30	6.24	8.40	7.30
	COP_d	-	5.20	3.60	4.70	3.60	3.90	3.35
Outdoor temperature (T_j) = +7°C	P_{dh}	kW	3.76	3.52	4.70	4.01	5.40	4.70
	COP_d	-	5.80	4.80	5.70	4.60	5.00	4.35
Outdoor temperature (T_j) = +12°C	P_{dh}	kW	3.70	3.60	3.50	3.50	3.50	3.60
	COP_d	-	6.40	5.80	6.00	5.50	6.00	5.50
Outdoor temperature (T_j) = Bivalent temperature (T_{biv})	P_{dh}	kW	9.60	8.60	12.00	10.25	13.80	12.00
	COP_d	-	2.74	1.80	2.55	1.70	2.40	1.60
Outdoor temperature (T_j) = Limit operation temperature (TOL)	P_{dh}	kW	10.50	7.40	12.10	9.00	14.10	10.50
	COP_d	-	2.65	1.70	2.50	1.60	2.30	1.40
Bivalent temperature (T_{biv})		°C	-7	-7	-7	-7	-7	-7
Limit operation temperature (TOL)		°C	-10	-10	-10	-10	-10	-10
Water limit operation temperature (WTOL)		°C	55	55	55	55	55	55
Degradation coefficient (Cdh)		-	0.9	0.9	0.9	0.9	0.9	0.9
Annual energy consumption (Q_{HE})		kW·h	4736 (4666)	5837 (5767)	6335 (6265)	7088 (7018)	8309 (8239)	8781 (8710)

◆ **WARMER climate****RAS-(2-3)WHVRP1 + RWD-(2.0-3.0)RW1E-220S(-K)**

Model	HP		2.0 HP	2.5 HP	3.0 HP
	Outdoor unit		RAS-2WHVRP1	RAS-2.5WHVRP1	RAS-3WHVRP1
	Indoor unit		RWD-2.0RW1E-220S(-K)	RWD-2.5RW1E-220S(-K)	RWD-3.0RW1E-220S(-K)
Design capacity (P_{DESIGN})	kW		4.0	5.0	6.0
⁽¹⁾ Nominal energy efficiency (η_S)	%		185 (194)	182 (189)	170 (175)
Data for Packaged Fiche:					
⁽²⁾ Energy efficiency with OTC control (η_S) (*)	%		187 (196)	184 (191)	172 (177)
⁽³⁾ Energy efficiency with thermostats (η_S) (*)	%		189 (198)	186 (193)	174 (177)
Annual energy consumption (Q_{HE})	kW·h		1137 (1084)	1441 (1389)	1857 (1804)

RAS-(4-6)WH(V)NPE + RWD-(4.0-6.0)NW1E-220S(-K)

Model	HP		4.0 HP	5.0 HP	6.0 HP
	Outdoor unit		RAS-4WHVNPE	RAS-5WHVNPE	RAS-6WHVNPE
	Indoor unit		RWD-4.0NW1E-220S(-K)	RWD-5.0NW1E-220S(-K)	RWD-6.0NW1E-220S(-K)
Design capacity (P_{DESIGN})	kW		10	12	14
⁽¹⁾ Nominal energy efficiency (η_S)	%		193	183	177
Data for Packaged Fiche:					
⁽²⁾ Energy efficiency with OTC control (η_S) (*)	%		195	185	179
⁽³⁾ Energy efficiency with thermostats (η_S) (*)	%		197	187	181
Annual energy consumption (Q_{HE})	kW·h		2722	3455	4149

Model	HP		4.0 HP	5.0 HP	6.0 HP
	Outdoor unit		RAS-4WHNPE	RAS-5WHNPE	RAS-6WHNPE
	Indoor unit		RWD-4.0NW1E-220S(-K)	RWD-5.0NW1E-220S(-K)	RWD-6.0NW1E-220S(-K)
Design capacity (P_{DESIGN})	kW		10	12	14
⁽¹⁾ Nominal energy efficiency (η_S)	%		191	181	176
Data for Packaged Fiche:					
⁽²⁾ Energy efficiency with OTC control (η_S) (*)	%		193	183	178
⁽³⁾ Energy efficiency with thermostats (η_S) (*)	%		195	185	180
Annual energy consumption (Q_{HE})	kW·h		2748	3481	4175

◆ **COLDER climate****RAS-(2-3)WHVRP1 + RWD-(2.0-3.0)RW1E-220S(-K)**

Model	HP		2.0 HP	2.5 HP	3.0 HP
	Outdoor unit		RAS-2WHVRP1	RAS-2.5WHVRP1	RAS-3WHVRP1
	Indoor unit		RWD-2.0RW1E-220S(-K)	RWD-2.5RW1E-220S(-K)	RWD-3.0RW1E-220S(-K)
Design capacity (P_{DESIGN})	kW		4.0	5.0	6.0
⁽¹⁾ Nominal energy efficiency (η_s)	%		123 (125)	122 (123)	118 (118)
Data for Packaged Fiche:					
⁽²⁾ Energy efficiency with OTC control (η_s) (*)	%		125 (127)	124(125)	120 (120)
⁽³⁾ Energy efficiency with thermostats (η_s) (*)	%		127 (129)	126 (127)	122 (122)
Annual energy consumption (Q_{HE})	kW·h		3058 (3031)	4048 (4021)	4910 (4884)

RAS-(4-6)WH(V)NPE + RWD-(4.0-6.0)NW1E-220S(-K)

Model	HP		4.0 HP	5.0 HP	6.0 HP
	Outdoor unit		RAS-4WHVNPE	RAS-5WHVNPE	RAS-6WHVNPE
	Indoor unit		RWD-4.0NW1E-220S(-K)	RWD-5.0NW1E-220S(-K)	RWD-6.0NW1E-220S(-K)
Design capacity (P_{DESIGN})	kW		11	12	14
⁽¹⁾ Nominal energy efficiency (η_s)	%		120	119	112
Data for Packaged Fiche:					
⁽²⁾ Energy efficiency with OTC control (η_s) (*)	%		122	121	114
⁽³⁾ Energy efficiency with thermostats (η_s) (*)	%		124	123	116
Annual energy consumption (Q_{HE})	kW·h		8641	9514	11620

Model	HP		4.0 HP	5.0 HP	6.0 HP
	Outdoor unit		RAS-4WHNPE	RAS-5WHNPE	RAS-6WHNPE
	Indoor unit		RWD-4.0NW1E-220S(-K)	RWD-5.0NW1E-220S(-K)	RWD-6.0NW1E-220S(-K)
Design capacity (P_{DESIGN})	kW		11	12	14
⁽¹⁾ Nominal energy efficiency (η_s)	%		120	119	112
Data for Packaged Fiche:					
⁽²⁾ Energy efficiency with OTC control (η_s) (*)	%		122	121	114
⁽³⁾ Energy efficiency with thermostats (η_s) (*)	%		124	123	116
Annual energy consumption (Q_{HE})	kW·h		8654	9528	11633

2.2.2.3 ERP additional data - YUTAKI S**RAS-(2-3)WHVRP1 + RWM-(2.0-3.0)R1E**

Model	HP	2.0 HP	2.5 HP	3.0 HP
	Outdoor unit	RAS-2WHVRP1	RAS-2.5WHVRP1	RAS-3WHVRP1
	Indoor unit	RWM-2.0R1E	RWM-2.5R1E	RWM-3.0R1E
Electrical power input in stand-by mode (Psb)	W	11.9	11.9	11.9
Electrical power input in thermostat-OFF mode (Pto)	W	0.0	0.0	0.0
Electrical power input in OFF mode (Poff)	W	11.9	11.9	11.9
Electrical power input in crankcase heater mode (Pck)	W	0.0	0.0	0.0
Sound power level of indoor unit (L _{WA})	dB(A)	37	37	37
Capacity control mode	-	Variable (Inverter)		
Integrated supplementary heater	kW	3.0	3.0	3.0
Nominal outdoor air flow	m ³ /h	2436	2436	2682

RAS-(4-6)WH(V)NPE + RWM-(4.0-6.0)N1E

Model	HP	4.0 HP	5.0 HP	6.0 HP
	Outdoor unit	RAS-4WHVNPE	RAS-5WHVNPE	RAS-6WHVNPE
	Indoor unit	RWM-4.0N1E	RWM-5.0N1E	RWM-6.0N1E
Electrical power input in stand-by mode (Psb)	W	13.1	13.1	13.1
Electrical power input in thermostat-OFF mode (Pto)	W	0.0	0.0	0.0
Electrical power input in OFF mode (Poff)	W	13.1	13.1	13.1
Electrical power input in crankcase heater mode (Pck)	W	0.0	0.0	0.0
Sound power level of indoor unit (L _{WA})	dB(A)	39	39	39
Sound power level of outdoor unit (L _{WA})	dB(A)	64	65	67
Capacity control mode	-	Variable (Inverter)		
Integrated supplementary heater	kW	6.0	6.0	6.0
Nominal outdoor air flow	m ³ /h	4800	5400	6000

Model	HP	4.0 HP	5.0 HP	6.0 HP
	Outdoor unit	RAS-4WHNPE	RAS-5WHNPE	RAS-6WHNPE
	Indoor unit	RWM-4.0N1E	RWM-5.0N1E	RWM-6.0N1E
Electrical power input in stand-by mode (Psb)	W	19.1	19.1	19.1
Electrical power input in thermostat-OFF mode (Pto)	W	0.0	0.0	0.0
Electrical power input in OFF mode (Poff)	W	19.1	19.1	19.1
Electrical power input in crankcase heater mode (Pck)	W	0.0	0.0	0.0
Sound power level of indoor unit (L _{WA})	dB(A)	39	39	39
Sound power level of outdoor unit (L _{WA})	dB(A)	64	65	67
Capacity control mode	-	Variable (Inverter)		
Integrated supplementary heater	kW	6.0	6.0	6.0
Nominal outdoor air flow	m ³ /h	4800	5400	6000

RAS-(8-10)WHNPE + RWM-(8.0-10.0)N1E

Model	HP		8.0 HP	10.0 HP
	Outdoor unit		RAS-8WHNPE	RAS-10WHNPE
	Indoor unit		RWM-8.0N1E	RWM-10.0N1E
Electrical power input in stand-by mode (Psb)	W		36	36
Electrical power input in thermostat-OFF mode (Pto)	W		0.0	0.0
Electrical power input in OFF mode (Poff)	W		36	36
Electrical power input in crankcase heater mode (Pck)	W		0.0	0.0
Sound power level of indoor unit (L _{WA})	dB(A)		47	47
Sound power level of outdoor unit (L _{WA})	dB(A)		73	74
Capacity control mode	-	Variable (inverter)		
Integrated supplementary heater	kW		9.0	9.0
Nominal outdoor air flow	m ³ /h		7620	8040

2.2.2.4 ERP additional data - YUTAKI S COMBI**RAS-(2-3)WHVRP1 + RWD-(2.0-3.0)RW1E-220S(-K)**

Model	HP		2.0 HP	2.5 HP	3.0 HP
	Outdoor unit		RAS-2WHVRP1	RAS-2.5WHVRP1	RAS-3WHVRP1
	Indoor unit		RWD-2.0RW1E-220S(-K)	RWD-2.5RW1E-220S(-K)	RWD-3.0RW1E-220S(-K)
Electrical power input in stand-by mode (Psb)	W		11.9	11.9	11.9
Electrical power input in thermostat-OFF mode (Pto)	W		0.0	0.0	0.0
Electrical power input in OFF mode (Poff)	W		11.9	11.9	11.9
Electrical power input in crankcase heater mode (Pck)	W		0.0	0.0	0.0
Sound power level of indoor unit (L _{WA})	dB(A)		37	37	37
Capacity control mode	-	Variable (Inverter)			
Integrated supplementary heater	kW		3.0	3.0	3.0
Nominal outdoor air flow	m ³ /h		2436	2436	2682

RAS-(4-6)WHVNPE + RWD-(4.0-6.0)NW1E-220S(-K)

Model	HP		4.0 HP	5.0 HP	6.0 HP
	Outdoor unit		RAS-4WHVNPE	RAS-5WHVNPE	RAS-6WHVNPE
	Indoor unit		RWD-4.0NW1E-220S(-K)	RWD-5.0NW1E-220S(-K)	RWD-6.0NW1E-220S(-K)
Electrical power input in stand-by mode (Psb)	W		13.1	13.1	13.1
Electrical power input in thermostat-OFF mode (Pto)	W		0.0	0.0	0.0
Electrical power input in OFF mode (Poff)	W		13.1	13.1	13.1
Electrical power input in crankcase heater mode (Pck)	W		0.0	0.0	0.0
Sound power level of indoor unit (L _{WA})	dB(A)		39	39	39
Sound power level of outdoor unit (L _{WA})	dB(A)		64	65	67
Capacity control mode	-	Variable (Inverter)			
Integrated supplementary heater	kW		6.0	6.0	6.0
Nominal outdoor air flow	m ³ /h		4800	5400	6000

RAS-(4-6)WHNPE + RWD-(4.0-6.0)NW1E-220S(-K)

Model	HP	4.0 HP	5.0 HP	6.0 HP
	Outdoor unit	RAS-4WHNPE	RAS-5WHNPE	RAS-6WHNPE
	Indoor unit	RWD-4.0NW1E-220S(-K)	RWD-5.0NW1E-220S(-K)	RWD-6.0NW1E-220S(-K)
Electrical power input in stand-by mode (Psb)	W	19.1	19.1	19.1
Electrical power input in thermostat-OFF mode (Pto)	W	0.0	0.0	0.0
Electrical power input in OFF mode (Poff)	W	19.1	19.1	19.1
Electrical power input in crankcase heater mode (Pck)	W	0.0	0.0	0.0
Sound power level of indoor unit (L_{WA})	dB(A)	39	39	39
Sound power level of outdoor unit (L_{WA})	dB(A)	64	65	67
Capacity control mode	-	Variable (Inverter)		
Integrated supplementary heater	kW	6.0	6.0	6.0
Nominal outdoor air flow	m ³ /h	4800	5400	6000

2.2.3 General ERP data for combi heaters**2.2.3.1 YUTAKI S COMBI****RAS-(2-3)WHVRP1 + RWD-(2.0-3.0)RW1E-220S(-K)**

Model	HP	2.0 HP	2.5 HP	3.0 HP
	Outdoor unit	RAS-2WHVRP1	RAS-2.5WHVRP1	RAS-3WHVRP1
	Indoor unit	RWD-2.0RW1E-220S(-K)	RWD-2.5RW1E-220S(-K)	RWD-3.0RW1E-220S(-K)
Declared profile	-	L	L	L
Ability to work during OFF peak hours	-	Yes		
AVERAGE climate				
Water heating energy efficiency (η_{wh})	%	130		
Water heating energy class	-	A+		
Daily electricity consumption	kW·h	2.15		
Annual energy consumption	kW·h	785		
WARMER climate				
Water heating energy efficiency (η_{wh})	%	145		
Daily energy consumption	kW·h	3.21		
Annual energy consumption	kW·h	706		
COLDER climate				
Water heating energy efficiency (η_{wh})	%	112		
Daily energy consumption	kW·h	4.16		
Annual energy consumption	kW·h	914		

RAS-(4-6)WH(V)NPE + RWD-(4.0-6.0)NW1E-220S(-K)

Model	HP	4.0 HP	5.0 HP	6.0 HP
	Outdoor unit	RAS-4WH(V)NPE	RAS-5WH(V)NPE	RAS-6WH(V)NPE
	Indoor unit	RWD-4.0NW1E-220S(-K)	RWD-5.0NW1E-220S(-K)	RWD-6.0NW1E-220S(-K)
Declared profile	-	L	L	L
Ability to work during OFF peak hours	-	Yes		
AVERAGE climate				
Water heating energy efficiency (η_{wh})	%	127		
Water heating energy class	-	A+		
Daily electricity consumption	kW·h	2.22		
Annual energy consumption	kW·h	809		
WARMER climate				
Water heating energy efficiency (η_{wh})	%	143		
Daily energy consumption	kW·h	3.26		
Annual energy consumption	kW·h	717		
COLDER climate				
Water heating energy efficiency (η_{wh})	%	111		
Daily energy consumption	kW·h	4.22		
Annual energy consumption	kW·h	928		

2.2.3.2 General ERP data for hot water storage tanks (YUTAKI S)

Model		DHWT-200S-3.0H2E	DHWT-300S-3.0H2E
Storage volume	L	194	264
Standing loss	W	47.3	62.8
Energy efficiency class	-	B	B

2.3 Cooling mode application (EN 14825) (Models with cooling kit accessory) (Preliminary data)

2.3.1 Cooling data (EN 14825) - YUTAKI S

RAS-(2-3)WHVRP1 + RWM-(2.0-3.0)R1E

Model		Outdoor unit		RAS-2WHVRP1		RAS-2.5WHVRP1		RAS-3WHVRP1	
		Indoor unit		RWM-2.0R1E		RWM-2.5R1E		RWM-3.0R1E	
Water outlet temperature				7°C	18°C	7°C	18°C	7°C	18°C
Product description	Outdoor side heat exchanger of chiller	-		Air to Water		Air to Water		Air to Water	
	Indoor side heat exchanger chiller	-		Water		Water		Water	
	Type	-		Compressor driven vapour compression		Compressor driven vapour compression		Compressor driven vapour compression	
	Driver of compressor	-		Electric motor		Electric motor		Electric motor	
	Capacity Control			Variable		Variable		Variable	
	Water control			Fixed		Fixed		Fixed	
Rated Cooling Capacity (PRATED,C)		kW		4.00	5.50	5.3	6.30	6.5	7.0
Seasonal space cooling energy efficiency ($\eta_{S,C}$)		%		220	319	218	338	208	331
Seasonal energy efficiency ratio cooling mode (SEER)		-		5.57	8.04	5.53	8.50	5.27	8.35
Seasonal active energy ratio cooling mode (SEERON)		-		5.79	8.38	5.69	8.53	5.39	8.64
Declared cooling capacity and efficiency ratio for part load at given outdoor temperatures Tj									
	Outdoor temperature (Tj) = 35°C	Pdc	kW	4.00	5.50	5.30	6.30	6.50	7.00
		EERd	-	4.00	5.40	3.60	5.30	3.35	5.00
	Outdoor temperature (Tj) = 30°C	Pdc	kW	2.95	4.05	3.91	4.64	4.79	5.16
		EERd	-	5.00	7.20	4.50	7.00	4.50	6.40
	Outdoor temperature (Tj) = 25°C	Pdc	kW	2.05	2.61	2.51	2.98	2.90	3.32
		EERd	-	6.45	9.60	6.30	9.90	6.00	10.0
	Outdoor temperature (Tj) = 20°C	Pdc	kW	2.88	2.51	2.88	2.65	3.40	3.60
		EERd	-	8.00	10.3	8.56	12.61	7.50	13.5
Degradation coefficient (Cdc)		-		0.9	0.9	0.9	0.9	0.9	0.9
Annual energy consumption (QCE)		kW·h		431	410	575	337	740	503

RAS-(4-6)WHVNPE + RWM-(4.0-6.0)N1E

Model		Outdoor unit		RAS-4WHVNPE		RAS-5WHVNPE		RAS-6WHVNPE	
		Indoor unit		RWM-4.0N1E		RWM-5.0N1E		RWM-6.0N1E	
Water outlet temperature				7°C	18°C	7°C	18°C	7°C	18°C
Product description	Outdoor side heat exchanger of chiller	-	Air to Water		Air to Water		Air to Water		
	Indoor side heat exchanger chiller	-	Water		Water		Water		
	Type	-	Compressor driven vapour compression		Compressor driven vapour compression		Compressor driven vapour compression		
	Driver of compressor	-	Electric motor		Electric motor		Electric motor		
	Capacity Control		Variable		Variable		Variable		
	Water control		Fixed		Fixed		Fixed		
Rated Cooling Capacity (PRATED,C)		kW	7.2	10.4	9.5	12.9	10.5	13.5	
Seasonal space cooling energy efficiency ($\eta_{S,C}$)		%	202	252	194	215	188	212	
Seasonal energy efficiency ratio cooling mode (SEER)		-	5.13	6.36	4.92	5.44	4.78	5.38	
Seasonal active energy ratio cooling mode (SEERON)		-	5.44	6.69	5.13	5.63	4.96	5.56	
Declared cooling capacity and efficiency ratio for part load at given outdoor temperatures Tj									
	Outdoor temperature (Tj) = 35°C	Pdc	kW	7.2	10.4	9.5	12.9	10.5	13.5
		EERd	-	3.84	4.5	3.4	4.02	3	3.81
	Outdoor temperature (Tj) = 30°C	Pdc	kW	5.3	7.66	7	9.51	7.8	9.95
		EERd	-	4.6	6.3	4.55	5.9	4.4	5.6
	Outdoor temperature (Tj) = 25°C	Pdc	kW	3.5	4.93	4.5	7.2	5	7.2
		EERd	-	5.8	7.2	5.3	6.2	5.1	6.2
	Outdoor temperature (Tj) = 20°C	Pdc	kW	3.6	5.1	3.2	7.8	3.2	7.8
		EERd	-	7.5	8.2	6.8	6.3	6.8	6.3
Degradation coefficient (Cdc)		-	0.9	0.9	0.9	0.9	0.9	0.9	
Annual energy consumption (QCE)		kW·h	491	572	676	830	768	878	

RAS-(4-6)WHNPE + RWM-(4.0-6.0)N1E

Model		Outdoor unit		RAS-4WHVNPE		RAS-5WHVNPE		RAS-6WHVNPE	
		Indoor unit		RWM-4.0N1E		RWM-5.0N1E		RWM-6.0N1E	
Water outlet temperature				7°C	18°C	7°C	18°C	7°C	18°C
Product description	Outdoor side heat exchanger of chiller	-		Air to Water		Air to Water		Air to Water	
	Indoor side heat exchanger chiller	-		Water		Water		Water	
	Type	-		Compressor driven vapour compression		Compressor driven vapour compression		Compressor driven vapour compression	
	Driver of compressor	-		Electric motor		Electric motor		Electric motor	
	Capacity Control			Variable		Variable		Variable	
	Water control			Fixed		Fixed		Fixed	
Rated Cooling Capacity (PRATED,C)		kW		7.02	10.4	9.5	10.9	10.5	13.5
Seasonal space cooling energy efficiency ($\eta_{S,C}$)		%		197	246	190	211	185	209
Seasonal energy efficiency ratio cooling mode (SEER)		-		5	6.22	4.83	5.36	4.7	5.3
Seasonal active energy ratio cooling mode (SEERON)		-		5.44	6.69	5.13	5.63	4.96	5.56
Declared cooling capacity and efficiency ratio for part load at given outdoor temperatures Tj									
	Outdoor temperature (Tj) = 35°C	Pdc	kW	7.2	10.4	9.5	12.9	10.5	13.5
		EERd	-	3.84	4.5	3.4	4.02	3	3.81
	Outdoor temperature (Tj) = 30°C	Pdc	kW	5.3	7.66	7	9.51	7.8	9.95
		EERd	-	4.6	6.3	4.55	5.9	4.4	5.6
	Outdoor temperature (Tj) = 25°C	Pdc	kW	3.5	4.93	4.5	7.2	5	7.2
		EERd	-	5.8	7.2	5.3	6.2	5.1	6.2
	Outdoor temperature (Tj) = 20°C	Pdc	kW	360	5.1	3.2	7.8	3.2	7.8
		EERd	-	7.5	8.2	6.8	6.3	6.8	6.3
Degradation coefficient (Cdc)		-		0.9	0.9	0.9	0.9	0.9	0.9
Annual energy consumption (QCE)		kW·h		504	585	688	843	781	891

RAS-(8-10)WHNPE + RWM-(8.0-10.0)N1E

Model		Outdoor unit		RAS-8WHVNPE		RAS-10WHVNPE	
		Indoor unit		RWM-8.0N1E		RWM-10.0N1E	
Water outlet temperature				7°C	18°C	7°C	18°C
Product description	Outdoor side heat exchanger of chiller	-		Air to Water		Air to Water	
	Indoor side heat exchanger chiller	-		Water		Water	
	Type	-		Compressor driven vapour compression		Compressor driven vapour compression	
	Driver of compressor	-		Electric motor		Electric motor	
	Capacity Control			Variable		Variable	
	Water control			Fixed		Fixed	
Rated Cooling Capacity (PRATED,C)		kW		14	17	17.5	20
Seasonal space cooling energy efficiency ($\eta_{S,C}$)		%		169	213	159	215
Seasonal energy efficiency ratio cooling mode (SEER)		-		4.29	5.4	4.06	5.44
Seasonal active energy ratio cooling mode (SEERON)		-		4.6	5.8	4.28	5.79
Declared cooling capacity and efficiency ratio for part load at given outdoor temperatures Tj							
	Outdoor temperature (Tj) = 35°C	Pdc	kW	14	17	17.5	20
		EERd	-	3.12	3.81	2.81	3.61
	Outdoor temperature (Tj) = 30°C	Pdc	kW	10.32	12.53	12.9	14.74
		EERd	-	3.92	5.6	3.53	5.5
	Outdoor temperature (Tj) = 25°C	Pdc	kW	6.5	8.2	8.2	8.2
		EERd	-	5.3	6.5	4.87	6.5
	Outdoor temperature (Tj) = 20°C	Pdc	kW	8	8.5	8	8.5
		EERd	-	5.8	6.6	5.5	6.6
Degradation coefficient (Cdc)		-		0.9	0.9	0.9	0.9
Annual energy consumption (QCE)		kW-h		1142	1102	1510	1286

2.3.2 Cooling data (EN 14825) - YUTAKI S COMBI**RAS-(2-3)WHVRP1 + RWD-(2.0-3.0)RW1E-220S(-K)**

Model		Outdoor unit		RAS-2WHVRP1		RAS-2.5WHVRP1		RAS-3WHVRP1	
		Indoor unit		RWD-2.0RW1E-220S(-K)		RWD-2.5RW1E-220S(-K)		RWD-3.0RW1E-220S(-K)	
Water outlet temperature				7°C	18°C	7°C	18°C	7°C	18°C
Product description	Outdoor side heat exchanger of chiller	-		Air to Water		Air to Water		Air to Water	
	Indoor side heat exchanger chiller	-		Water		Water		Water	
	Type	-		Compressor driven vapour compression		Compressor driven vapour compression		Compressor driven vapour compression	
	Driver of compressor	-		Electric motor		Electric motor		Electric motor	
	Capacity Control			Variable		Variable		Variable	
	Water control			Fixed		Fixed		Fixed	
Rated Cooling Capacity (PRATED,C)		kW		4.00	5.50	5.3	6.30	6.5	7.0
Seasonal space cooling energy efficiency ($\eta_{S,C}$)		%		220	319	218	338	208	331
Seasonal energy ratio cooling mode (SEER)		-		5.57	8.04	5.53	8.50	5.27	8.35
Seasonal active energy ratio cooling mode (SEERON)		-		5.79	8.38	5.69	8.53	5.39	8.64
Declared cooling capacity and efficiency ratio for part load at given outdoor temperatures T_j									
	Outdoor temperature (T_j) = 35°C	Pdc	kW	4.00	5.50	5.30	6.30	6.50	7.00
		EERd	-	4.00	5.40	3.60	5.30	3.35	5.00
	Outdoor temperature (T_j) = 30°C	Pdc	kW	2.95	4.05	3.91	4.64	4.79	5.16
		EERd	-	5.00	7.20	4.50	7.00	4.50	6.40
	Outdoor temperature (T_j) = 25°C	Pdc	kW	2.05	2.61	2.51	2.98	2.90	3.32
		EERd	-	6.45	9.60	6.30	9.90	6.00	10.0
	Outdoor temperature (T_j) = 20°C	Pdc	kW	2.88	2.51	2.88	2.65	3.40	3.60
		EERd	-	8.00	10.3	8.56	12.61	7.50	13.5
Degradation coefficient (Cdc)		-		0.9	0.9	0.9	0.9	0.9	0.9
Annual energy consumption (QCE)		kW·h		431	410	575	337	740	503

RAS-(4-6)WHVNPE + RWD-(4.0-6.0)NW1E-220S

Model		Outdoor unit		RAS-4WHVNPE		RAS-5WHVNPE		RAS-6WHVNPE	
		Indoor unit		RWD-4.0NW1E-220S(-K)		RWD-5.0NW1E-220S(-K)		RWD-6.0NW1E-220S(-K)	
Water outlet temperature				7°C	18°C	7°C	18°C	7°C	18°C
Product description	Outdoor side heat exchanger of chiller	-		Air to Water		Air to Water		Air to Water	
	Indoor side heat exchanger chiller	-		Water		Water		Water	
	Type	-		Compressor driven vapour compression		Compressor driven vapour compression		Compressor driven vapour compression	
	Driver of compressor	-		Electric motor		Electric motor		Electric motor	
	Capacity Control			Variable		Variable		Variable	
	Water control			Fixed		Fixed		Fixed	
Rated Cooling Capacity (PRATED,C)		kW		7.2	10.4	9.5	12.9	10.5	13.5
Seasonal space cooling energy efficiency ($\eta_{S,C}$)		%		202	252	194	215	188	212
Seasonal energy ratio cooling mode (SEER)		-		5.13	6.36	4.92	5.44	4.78	5.38
Seasonal active energy ratio cooling mode (SEERON)		-		5.44	6.69	5.13	5.63	4.96	5.56
Declared cooling capacity and efficiency ratio for part load at given outdoor temperatures Tj									
	Outdoor temperature (Tj) = 35°C	Pdc	kW	7.2	10.4	9.5	12.9	10.5	13.5
		EERd	-	3.84	4.5	3.4	4.02	3	3.81
	Outdoor temperature (Tj) = 30°C	Pdc	kW	5.3	7.66	7	9.51	7.8	9.95
		EERd	-	4.6	6.3	4.55	5.9	4.4	5.6
	Outdoor temperature (Tj) = 25°C	Pdc	kW	3.5	4.93	4.5	7.2	5	7.2
		EERd	-	5.8	7.2	5.3	6.2	5.1	6.2
	Outdoor temperature (Tj) = 20°C	Pdc	kW	3.6	5.1	3.2	7.8	3.2	7.8
		EERd	-	7.5	8.2	6.8	6.3	6.8	6.3
Degradation coefficient (Cdc)		-		0.9	0.9	0.9	0.9	0.9	0.9
Annual energy consumption (QCE)		kW·h		491	572	676	830	768	878

RAS-(4-6)WHNPE + RWD-(4.0-6.0)NW1E-220S

Model		Outdoor unit		RAS-4WHNPE		RAS-5WHNPE		RAS-6WHNPE		
		Indoor unit		RWD-4.0NW1E-220S(-K)		RWD-5.0NW1E-220S(-K)		RWD-6.0NW1E-220S(-K)		
Water outlet temperature				7°C	18°C	7°C	18°C	7°C	18°C	
Product description	Outdoor side heat exchanger of chiller	-		Air to Water		Air to Water		Air to Water		
	Indoor side heat exchanger chiller	-		Water		Water		Water		
	Type	-		Compressor driven vapour compression		Compressor driven vapour compression		Compressor driven vapour compression		
	Driver of compressor	-		Electric motor		Electric motor		Electric motor		
	Capacity Control			Variable		Variable		Variable		
	Water control			Fixed		Fixed		Fixed		
Rated Cooling Capacity (PRATED,C)		kW		7.02	10.4	9.5	10.9	10.5	13.5	
Seasonal space cooling energy efficiency ($\eta_{S,C}$)		%		197	246	190	211	185	209	
Seasonal energy ratio cooling mode (SEER)		-		5	6.22	4.83	5.36	4.7	5.3	
Seasonal active energy ratio cooling mode (SEERON)		-		5.44	6.69	5.13	5.63	4.96	5.56	
Declared cooling capacity and efficiency ratio for part load at given outdoor temperatures Tj										
	Outdoor temperature (Tj) = 35°C	Pdc	kW	7.2	10.4	9.5	12.9	10.5	13.5	
		EERd	-	3.84	4.5	3.4	4.02	3	3.81	
	Outdoor temperature (Tj) = 30°C	Pdc	kW	5.3	7.66	7	9.51	7.8	9.95	
		EERd	-	4.6	6.3	4.55	5.9	4.4	5.6	
	Outdoor temperature (Tj) = 25°C	Pdc	kW	3.5	4.93	4.5	7.2	5	7.2	
		EERd	-	5.8	7.2	5.3	6.2	5.1	6.2	
	Outdoor temperature (Tj) = 20°C	Pdc	kW	360	5.1	3.2	7.8	3.2	7.8	
		EERd	-	7.5	8.2	6.8	6.3	6.8	6.3	
	Degradation coefficient (Cdc)		-		0.9	0.9	0.9	0.9	0.9	0.9
	Annual energy consumption (QCE)		kW·h		504	585	688	843	781	891

2.3.3 Additional Cooling data (EN 14825) - YUTAKI S**RAS-(2-3)WHVRP1 + RWM-(2.0-3.0)R1E**

Model		Outdoor unit		RAS-2WHVRP1		RAS-2.5WHVRP1		RAS-3WHVRP1	
		Indoor unit		RWM-2.0R1E		RWM-2.5R1E		RWM-3.0R1E	
Electrical power input in stand-by mode cooling mode (Psb)		W		11.9		11.9		11.9	
Electrical power input in thermostat-OFF cooling mode (Pto)		W		0		0		0	
Electrical power input in OFF mode (Poff)		W		11.9		11.9		11.9	
Electrical power input in crankcase heater in cooling mode (Pck)		W		0		0		0	
Sound power level of indoor unit (LWA)		dB(A)		37		37		37	
Sound power level of outdoor unit (LWA)		dB(A)		61		63		64	
Capacity control mode		-		Variable (Inverter)		Variable (Inverter)		Variable (Inverter)	
Nominal outdoor air flow		m³/h		2436		2436		2682	

RAS-(4-6)WH(V)NPE + RWM-(4.0-6.0)N1E

Model	Outdoor unit	RAS-4WHVNPE	RAS-5WHVNPE	RAS-6WHVNPE
	Indoor unit	RWM-4.0N1E	RWM-5.0N1E	RWM-6.0N1E
Electrical power input in stand-by mode cooling mode (Psb)	W	13.1	13.1	13.1
Electrical power input in thermostat-OFF cooling mode (Pto)	W	0.0	0.0	0.0
Electrical power input in OFF mode (Poff)	W	13.1	13.1	13.1
Electrical power input in crankcase heater in cooling mode (Pck)	W	0.0	0.0	0.0
Sound power level of indoor unit (LWA)	dB(A)	39	39	39
Sound power level of outdoor unit (LWA)	dB(A)	64	65	67
Capacity control mode	-	Variable (Inverter)	Variable (Inverter)	Variable (Inverter)
Nominal outdoor air flow	m ³ /h	4800	5400	6000

RAS-(4-6)WH(V)NPE + RWM-(4.0-6.0)N1E

Model	Outdoor unit	RAS-4WHNPE	RAS-5WHNPE	RAS-6WHNPE
	Indoor unit	RWM-4.0N1E	RWM-5.0N1E	RWM-6.0N1E
Electrical power input in stand-by mode cooling mode (Psb)	W	19.1	19.1	19.1
Electrical power input in thermostat-OFF cooling mode (Pto)	W	0.0	0.0	0.0
Electrical power input in OFF mode (Poff)	W	19.1	19.1	19.1
Electrical power input in crankcase heater in cooling mode (Pck)	W	0.0	0.0	0.0
Sound power level of indoor unit (LWA)	dB(A)	39	39	39
Sound power level of outdoor unit (LWA)	dB(A)	64	65	67
Capacity control mode	-	Variable (Inverter)	Variable (Inverter)	Variable (Inverter)
Nominal outdoor air flow	m ³ /h	4800	5400	6000

RAS-(8-10)WHNPE + RWM-(8.0-10.0)N1E

Model	Outdoor unit	RAS-8WHNPE	RAS-10WHNPE
	Indoor unit	RWM-8.0N1E	RWM-10.0N1E
Electrical power input in stand-by mode cooling mode (Psb)	W	36	36
Electrical power input in thermostat-OFF cooling mode (Pto)	W	0.0	0.0
Electrical power input in OFF mode (Poff)	W	36	36
Electrical power input in crankcase heater in cooling mode (Pck)	W	0.0	0.0
Sound power level of indoor unit (LWA)	dB(A)	47	47
Sound power level of outdoor unit (LWA)	dB(A)	73	74
Capacity control mode	-	Variable (Inverter)	Variable (Inverter)
Nominal outdoor air flow	m ³ /h	7620	8040

2.3.4 Additional Cooling data (EN 14825) - YUTAKI S COMBI**RAS-(2-3)WHVRP1 + RWD-(2.0-3.0)RW1E-220S(-K)**

Model	Outdoor unit		RAS-2WHVRP1	RAS-2.5WHVRP1	RAS-3WHVRP1
	Indoor unit		RWD-2.0RW1E-220S(-K)	RWD-2.5RW1E-220S(-K)	RWD-3.0RW1E-220S(-K)
Electrical power input in stand-by mode cooling mode (Psb)	W		11.9	11.9	11.9
Electrical power input in thermostat-OFF cooling mode (Pto)	W		0	0	0
Electrical power input in OFF mode (Poff)	W		11.9	11.9	11.9
Electrical power input in crankcase heater in cooling mode (Pck)	W		0	0	0
Sound power level of indoor unit (LWA)	dB(A)		37	37	37
Sound power level of outdoor unit (LWA)	dB(A)		61	63	64
Capacity control mode	-		Variable (Inverter)	Variable (Inverter)	Variable (Inverter)
Nominal outdoor air flow	m ³ /h		2436	2436	2682

RAS-(4-6)WHVNPE + RWD-(4.0-6.0)NW1E-220S(-K)

Model	Outdoor unit		RAS-4WHVNPE	RAS-5WHVNPE	RAS-6WHVNPE
	Indoor unit		RWD-4.0NW1E-220S(-K)	RWD-5.0NW1E-220S(-K)	RWD-6.0NW1E-220S(-K)
Electrical power input in stand-by mode cooling mode (Psb)	W		13.1	13.1	13.1
Electrical power input in thermostat-OFF cooling mode (Pto)	W		0.0	0.0	0.0
Electrical power input in OFF mode (Poff)	W		13.1	13.1	13.1
Electrical power input in crankcase heater in cooling mode (Pck)	W		0.0	0.0	0.0
Sound power level of indoor unit (LWA)	dB(A)		39	39	39
Sound power level of outdoor unit (LWA)	dB(A)		64	65	67
Capacity control mode	-		Variable (Inverter)	Variable (Inverter)	Variable (Inverter)
Nominal outdoor air flow	m ³ /h		4800	5400	6000

RAS-(4-6)WHNPE + RWD-(4.0-6.0)NW1E-220S(-K)

Model	Outdoor unit		RAS-4WHNPE	RAS-5WHNPE	RAS-6WHNPE
	Indoor unit		RWD-4.0NW1E-220S(-K)	RWD-5.0NW1E-220S(-K)	RWD-6.0NW1E-220S(-K)
Electrical power input in stand-by mode cooling mode (Psb)	W		19.1	19.1	19.1
Electrical power input in thermostat-OFF cooling mode (Pto)	W		0.0	0.0	0.0
Electrical power input in OFF mode (Poff)	W		19.1	19.1	19.1
Electrical power input in crankcase heater in cooling mode (Pck)	W		0.0	0.0	0.0
Sound power level of indoor unit (LWA)	dB(A)		39	39	39
Sound power level of outdoor unit (LWA)	dB(A)		64	65	67
Capacity control mode	-		Variable (Inverter)	Variable (Inverter)	Variable (Inverter)
Nominal outdoor air flow	m ³ /h		4800	5400	6000

2.4 General specifications

2.4.1 Considerations

- The sound data is based on the following conditions:
 - Outdoor ambient temperature (DB/WB): 7/6°C.
 - Water inlet/outlet temperature: 47/55°C (mark: *1); 30/35°C (mark: *2).
 - Distance of the unit from the measuring point: At 1 meter from the unit's front surface; 1,5 meter from floor level.
 - The sound pressure level is measured in an anechoic chamber, so reflected sound should be taken into consideration when installing the unit.
 - The sound power level is measured in a reverberant room, in accordance with the standard EN12102. Used environment conditions are the same that specified in EN14511 for performance test.
- The nominal water flow rate is calculated under the following conditions:
 - Outdoor ambient temperature (DB/WB): 7/6°C.
 - Water inlet/outlet temperature: 47/55°C (mark: *1); 30/35°C (mark: *2).
- Regarding data market with mark: *3, it corresponds to the height of the unit with the minimum mounting foot height. This value can be adjusted up to +30 mm.
- For specific details about data corresponding to the working range, please refer to the chapter "5. Working range".

Keywords:

- DB: Dry bulb
- WB: Wet bulb

2.4.2 Split system - Outdoor unit (Preliminary data)

RAS-(2-3)WHVRP1

Model			RAS-2WHVRP1	RAS-2.5WHVRP1	RAS-3WHVRP1
Power supply		-	1~ 230V 50Hz		
Noise level (sound power)	(*1)	dB(A)	61	63	69
	(*2)		61	63	67
Air flow		m ³ /min	42.1	42.1	49.7
Cabinet colour (Munsell code)		-	Natural Gray (1.0Y 8.5/0.5)		
Dimensions (H x W x D)		mm	629 x 799 (+99) x 300		
Net weight		kg	45	45	44
Gross weight		kg	49	49	48
Piping diameter (liquid / gas)		mm (in.)	Ø6.35 (1/4) / Ø12.7 (1/2)	Ø6.35 (1/4) / Ø12.7 (1/2)	Ø6.35 (1/4) / Ø15.88 (5/8)
Minimum piping length		m	3		
Maximum chargeless piping length		m	10		
Maximum piping length		m	50	50	40
Height difference between OU and IU (higher OU / lower OU)		m	30 / 20		
Working range (Heating)	Outdoor ambient temperature	°C (DB)	-20~25		
	Outlet water temperature	°C	20~60		
Working range (Cooling)	Outdoor ambient temperature	°C (DB)	10~46		
	Outlet water temperature	°C	5~22		
Working range (DHW)	Outdoor ambient temperature	°C (DB)	-20~35		
	Tank water temperature	°C	30~75		
Refrigerant		-	R32		
Refrigerant charge before shipment		kg	1.2	1.3	1.3
Compressor type		-	Scroll DC Inverter driven		Rotary DC Inverter driven

RAS-(4-6)WHVNPE

Model		RAS-4WHVNPE	RAS-5WHVNPE	RAS-6WHVNPE
Power supply	-	1~ 230V 50Hz		
Noise level (sound pressure)	dB(A)	49	50	50
Noise level (sound power)	(*1)	64	65	67
	(*2)	63	64	65
Air flow	m ³ /min	80	90	100
Cabinet colour (Munsell code)	-	Natural grey (1.0Y 8.5/0.5)		
Dimensions (H x W x D)	mm	1380 x 950 x 370		
Net weight	kg	103	103	103
Gross weight	kg	116	116	116
Piping diameter (liquid / gas)	mm (in.)	Ø9.52 (3/8) / Ø15.88 (5/8)	Ø9.52 (3/8) / Ø15.88 (5/8)	Ø9.52 (3/8) / Ø15.88 (5/8)
Minimum piping length	m	5		
Maximum chargeless piping length	m	15		
Maximum piping length (additional refrigerant charge needed)	m (g/m)	75 (60)		
Height difference between OU and IU (higher OU / lower OU)	m	30 / 20		
Working range (cooling // heating // DHW)	°C (DB)	10~+46 // -25~+25 // -25~+35		
Refrigerant	-	R410A		
Refrigerant charge before shipment	kg	3.3	3.4	3.4
Compressor type	-	Scroll DC Inverter driven		

RAS-(4-6)WHNPE

Model		RAS-4WHNPE	RAS-5WHNPE	RAS-6WHNPE
Power supply	-	3N~ 400V 50Hz		
Noise level (sound pressure)	dB(A)	49	50	50
Noise level (sound power)	(*1)	64	65	67
	(*2)	63	64	65
Air flow	m ³ /min	80	90	100
Cabinet colour (Munsell code)	-	Natural grey (1.0Y 8.5/0.5)		
Dimensions (H x W x D)	mm	1380 x 950 x 370		
Net weight	kg	103	103	103
Gross weight	kg	116	116	116
Piping diameter (liquid / gas)	mm (in.)	Ø9.52 (3/8) / Ø15.88 (5/8)	Ø9.52 (3/8) / Ø15.88 (5/8)	Ø9.52 (3/8) / Ø15.88 (5/8)
Minimum piping length	m	5		
Maximum chargeless piping length	m	15		
Maximum piping length (additional refrigerant charge needed)	m (g/m)	75 (60)		
Height difference between OU and IU (higher OU / lower OU)	m	30 / 20		
Working range (cooling // heating // DHW)	°C (DB)	10~+46 // -25~+25 // -25~+35		
Refrigerant	-	R410A		
Refrigerant charge before shipment	kg	3.3	3.4	3.4
Compressor type	-	Scroll DC Inverter driven		

RAS-(8-10)WHNPE

Model		RAS-8WHNPE	RAS-10WHNPE
Power supply	-	3N~ 400V 50Hz	
Noise level (sound pressure)	dB(A)	59	60
Noise level (sound power)	(*1)	73	74
	(*2)	71	72
Air flow	m ³ /min	127	134
Cabinet colour (Munsell code)	-	Natural grey (1.0Y 8.5/0.5)	
Dimensions (H x W x D)	mm	1380 x 950 x 370	
Net weight	kg	137	139
Gross weight	kg	152	154
Piping diameter (liquid / gas)	mm (in.)	Ø9.52 (3/8) / Ø25.4	Ø12.70 (1/2) / Ø25.4
Minimum piping length	m	5	
Maximum chargeless piping length	m	15	
Maximum piping length (additional refrigerant charge needed)	m (g/m)	70 (65)	
Height difference between OU and IU (higher OU / lower OU)	m	30 / 20	
Refrigerant	-	R410A	
Refrigerant charge before shipment	kg	5.0	5.3
Compressor type	-	Scroll DC Inverter driven	

2.4.3 Split system - Indoor unit (Preliminary data)**2.4.3.1 YUTAKI S****RWM-(2.0-3.0)R1E**

Model		RWM-2.0R1E	RWM-2.5R1E	RWM-3.0R1E
Power supply	-	1~ 230V 50Hz / 3N~ 400V 50Hz		
Noise level (sound power)	dB(A)	37		
Minimum water flow rate	m ³ /h	0.5	0.6	0.6
Maximum water flow rate	m ³ /h	1.9	2.0	2.1
Cabinet	Material	Precoated galvanised steel		
	Colour	Pure white (RAL 9010)		
Unit dimensions	Height (with connections)	712 (782)		
	Width	450		
	Depth	285		
Packaging dimensions	Height	478		
	Width	905		
	Depth	539		
Packaging volume	m ³	0.23		
Packaging materials	-	Wood - Carton - Plastic		
Net weight	kg	35	36	37
Gross weight	kg	44	45	46
Refrigerant pipes connection	Connection type	Flare nut connection		
	Liquid pipe diameter	mm (in.)	Ø6.35 (1/4")	Ø9.52 (3/8")
	Gas pipe diameter	mm (in.)	Ø15.88 (5/8")	
Space heating pipes connection	Connection type	Screwed connection		
	Shutdown valves	mm (in.)	G 1" (male) - G 1" (male)	
	Inlet pipe diameter	mm (in.)	G 1" (female)	
	Outlet pipe diameter	mm (in.)	G 1" (female)	
Working range (Heating)	Outdoor ambient temperature	°C (DB)	-20~25	
	Indoor ambient temperature	°C (DB)	5~30	
	Outlet water temperature	°C	20~60	
Working range (Cooling)	Outdoor ambient temperature	°C (DB)	10~46	
	Indoor ambient temperature	°C (DB)	5~30	
	Outlet water temperature	°C	5~22	

RWM-(4.0-10.0)N1E

Model		RWM-4.0N1E	RWM-5.0N1E	RWM-6.0N1E	RWM-8.0N1E	RWM-10.0N1E
Power supply	-	1~ 230V 50Hz / 3N~ 400V 50Hz			3N~ 400V 50Hz	
Noise level (sound power)	dB(A)	39			47	
Minimum water flow rate	m ³ /h	1.0	1.1	1.2	2.0	2.2
Maximum water flow rate	m ³ /h	2.9	3.0	3.0	4.5	4.6
Cabinet	Material	Precoated galvanised steel				
	Colour	Pure white (RAL 9010)				
Unit dimensions	Height (with connections)	890 (960)				
	Width	520			670	
	Depth	370				
Packaging dimensions	Height	556				
	Width	1120				
	Depth	610			760	
Packaging volume	m ³	0.38			0.47	
Packaging materials	-	Wood - Carton - Plastic				
Net weight	kg	46	48		60	62
Gross weight	kg	61	63		76	78
Refrigerant pipes connection	Connection type	-	Flare nut connection			Liquid pipe: Flare nut connection; Gas pipe: Brazed connection
	Liquid pipe diameter	mm (in.)	Ø9.52 (3/8")			Ø12.7 (3/8")
	Gas pipe diameter	mm (in.)	Ø15.88 (5/8")			Ø25.4 (1")
Space heating pipes connection	Connection type	-	Screwed connection			
	Shutdown valves	mm (in.)	G 1-1/4" (male) - G 1-1/4" (male)			
	Inlet pipe diameter	mm (in.)	G 1-1/4" (female)			
	Outlet pipe diameter	mm (in.)	G 1-1/4" (female)			
Working range (Heating)	Outdoor ambient temperature	°C (DB)	-25~25			
	Indoor ambient temperature	°C (DB)	5~30			
	Outlet water temperature	°C	20~60			
Working range (Cooling)	Outdoor ambient temperature	°C (DB)	10~46			
	Indoor ambient temperature	°C (DB)	5~30			
	Outlet water temperature	°C	5~22			

2.4.3.2 YUTAKI S COMBI

◆ Standard model and UK market model

RWD-(2.0-3.0)RW1E-220S(-K)

Model		RWD-2.0RW1E-220S(-K)	RWD-2.5RW1E-220S(-K)	RWD-3.0RW1E-220S(-K)
Power supply	-	1~ 230V 50Hz / 3N~ 400V 50Hz		
Noise level (sound power)	dB(A)	37		
Minimum water flow rate	m ³ /h	0.5	0.6	0.6
Maximum water flow rate	m ³ /h	1.8	1.9	1.9
Cabinet	Material	Precoated galvanised steel		
	Colour	Pure white (RAL 9010)		
Unit dimensions	Height (with connections)	1788 (1889)		
	Width	595		
	Depth	598		
Packaging dimensions	Height	2045		
	Width	670		
	Depth	656		
Packaging volume	m ³	0.90		
Packaging materials	-	Wood - Carton - Plastic		
Net weight	kg	120	120	121
Gross weight	kg	131	131	132
Refrigerant pipes connection	Connection type	Flare nut connection		
	Liquid pipe diameter	mm (in.)	Ø6.35 (1/4")	Ø9.52 (3/8")
	Gas pipe diameter	mm (in.)	Ø15.88 (5/8")	
Space heating pipes connection	Connection type	Screwed connection		
	Shut-off valves	mm (in.)	G 1" (male) - G 1" (male)	
	Inlet pipe diameter	mm (in.)	G 1" (female)	
	Outlet pipe diameter	mm (in.)	G 1" (female)	
DHW pipes connection	Connection type	Screwed connection		
	Inlet pipe diameter	mm (in.)	G 3/4" (male)	
	Outlet pipe diameter	mm (in.)	G 3/4" (male)	
Working range (Heating)	Outdoor ambient temperature	°C (WB)	-20~25	
	Indoor ambient temperature	°C (WB)	5~30	
	Outlet water temperature	°C	20~60	
Working range (Cooling)	Outdoor ambient temperature	°C (DB)	10~46	
	Indoor ambient temperature	°C (DB)	5~30	
	Outlet water temperature	°C	5~22	
Working range (DHW)	Outdoor ambient temperature	°C (DB)	-20~35	
	Indoor ambient temperature	°C (DB)	5~30	
	Tank water temperature	°C	30~75	

RWD-(4.0-6.0)NW1E-220S(-K)

Model		RWD-4.0NW1E-220S(-K)	RWD-5.0NW1E-220S(-K)	RWD-6.0NW1E-220S(-K)
Power supply	-	1~ 230V 50Hz / 3N~ 400V 50Hz		
Noise level (sound power)	dB(A)	39		
Minimum water flow rate	m ³ /h	1.0	1.1	1.2
Maximum water flow rate	m ³ /h	2.7	2.8	2.8
Cabinet	Material	Precoated galvanised steel		
	Colour	Pure white (RAL 9010)		
Unit dimensions	Height (with connections)	1788 (1889)		
	Width	595		
	Depth	598		
Packaging dimensions	Height	2045		
	Width	670		
	Depth	656		
Packaging volume	m ³	0.90		
Packaging materials	-	Wood - Carton - Plastic		
Net weight	kg	124	126	126
Gross weight	kg	135	137	137
Refrigerant pipes connection	Connection type	Flare nut connection		
	Liquid pipe diameter	Ø9.52 (3/8")		
	Gas pipe diameter	Ø15.88 (5/8")		
Space heating pipes connection	Connection type	Screwed connection		
	Shut-off valves	G 1" (male) - G 1" (male)		
	Inlet pipe diameter	G 1" (female)		
	Outlet pipe diameter	G 1" (female)		
DHW pipes connection	Connection type	Screwed connection		
	Inlet pipe diameter	G 3/4" (male)		
	Outlet pipe diameter	G 3/4" (male)		
Working range (Heating)	Outdoor ambient temperature	°C (WB) -25~25		
	Indoor ambient temperature	°C (WB) 5~30		
	Outlet water temperature	°C 20~60		
Working range (Cooling)	Outdoor ambient temperature	°C (DB) 10~46		
	Indoor ambient temperature	°C (DB) 5~30		
	Outlet water temperature	°C 5~22		
Working range (DHW)	Outdoor ambient temperature	°C (DB) -25~35		
	Indoor ambient temperature	°C (DB) 5~30		
	Tank water temperature	°C 30~75		

2.4.4 Domestic Hot Water Tank

Model				DHWT-200S-3.0H2E	DHWT-300S-3.0H2E	
Casing	Color			White		
	Material			Polypropylene jacked		
Dimensions	Packing	Height	mm	1300	1880	
		Width	mm	600	600	
		Depth	mm	600	600	
	Unit	Height	mm	1270	1750	
		Width	mm	595	595	
		Depth	mm	595	595	
Weight	Unit		kg	53	63	
	Packed unit		kg	63.5	73	
Packing	Material			EPS		
	Weight			CARTON		
Main components	Tank	Water volume	L	194	282	
		Material			Stainless Steel	
		Max tank temperature	°C	75	75	
		Max tank water pressure	bar	10	10	
		Maximum heating coil water working temperature	°C	99	99	
		Maximum heating coil water working pressure	bar	10	10	
Tank	Insulation	Material			Polyurethane	
		Heat loss (*)	kW·h/day	1.128	1.512	
		Min thickness	mm	50	50	
Main components	Heat exchanger	Quantity			1	1
		Coil surface area	m ²	1.4	1.8	
	Booster heater	Quantity			1	1
		Heater rating	kW	3	3	
	Type			Immersion heater type		
Piping connections	Water inlet domestic connection		inches	¾ (female)		
	Water outlet domestic connection		inches	¾ (female)		
	Recirculation		inches	¾ (female)		
	In coil connection		inches	¾ (female)		
	Out coil connection		inches	¾ (female)		
Thermometer				Yes		
Mechanical thermostat (security)				Yes		
Protection				-		

NOTE

(*): Heat loss according to EN-12897:2007

2.5 Component data (Preliminary data)

2.5.1 Split system - Outdoor unit

RAS-(2-3)WHVRP1

MODEL		RAS-2WHVRP1	RAS-2.5WHVRP1	RAS-3WHVRP1
Air heat exchanger	Type	Multi-pass cross-finned tube		
	Pipe material	Copper		
	Outer diameter	mm	8	
	Rows	2		
	Number of tubes in the heat exchanger	44		
	Fin material	Aluminium		
	Fin pitch	1.45		
	Maximum operating pressure	MPa	4.15	
	Total front area	m ²	0.47	
	Number of heat exchanger per unit	1		
Fan	Fan type	Direct drive propeller fan		
	Fans per unit	1		
	Outer diameter	mm	449	
	Revolutions	rpm	790	970
	Nominal air flow	m ³ /min	45.9	57
Motor	Shell	Drip-proof type enclosure		
	Starting	Direct current control		
	Power	W	40	
	Quantity	1		
	Insulation class	E		
Compressor	Model	EX118HF1	GTD163UK QA8LTH	
	Oil Type	ACS68R		
	Quantity (l)	0.75		

RAS-(4-10)WH(V)NPE

MODEL		RAS-4WH(V) NPE	RAS-5WH(V) NPE	RAS-6WH(V) NPE	RAS- 8WHNPE	RAS- 10WHNPE	
Air heat exchanger	Type	Multi-pass cross-finned tube					
	Pipe material	Copper					
	Outer diameter	mm	7				
	Rows	2			3		
	Number of tubes in the heat exchanger	132			198		
	Fin material	Aluminium					
	Fin pitch	1.4					
	Maximum operating pressure	MPa	4.15				
	Total front area	m ²	1.35				
	Number of heat exchanger per unit	1					
Fan	Fan type	Direct drive propeller fan					
	Fans per unit	2					
	Outer diameter	mm	544				
	Revolutions	rpm	459 / 376	516 / 422	573 / 469	586 / 717	644 / 787
	Nominal air flow	m ³ /min	80	90	100	127	134
Motor	Shell	Drip-proof type enclosure					
	Starting	Direct current control					
	Power	W	100 + 100			138 + 138	
	Quantity	2					
	Insulation class	E					
Compressor	Model	E402HHD-36A2 (1~) / E402HHD-36D2 (3N~)			DA50PHD- D1SE2	DA65PHD- D1SE2	
	Oil Type	FVC68D					
	Quantity (l)	0.90			1.90		

2.5.2 Split system - Indoor unit

2.5.2.1 YUTAKI S

Model		RWM-2.0R1E	RWM-2.5R1E	RWM-3.0R1E	RWM-4.0N1E	RWM-5.0N1E	RWM-6.0N1E	RWM-8.0N1E	RWM-10.0N1E	
Water heat exchanger	Type	- Brazed plate								
	Material	- Stainless steel								
	Transfer fluids	- R32 - H ₂ O				- R410A - H ₂ O				
	Quantity	- 1								
	Internal refrigerant volume	L	0.54	0.73	0.81	1.55	2.09	2.09	3.19	3.91
	Internal water volume	L	0.57	0.76	0.84	1.64	2.18	2.18	3.28	4.00
	Insulation material	- NBR + PVC								
Water pump	Model	- UPM3 K 15-75 130 AZA 6 HIT			- UPM3L K 15-75 130 AZA 6 HIT			- UPML GEO 25-105 180 3H PWM		
	Type	- Inverter								
	Control	- PWM								
	Power supply	- 1~ 230V 50Hz								
	Maximum lift pressure	mwp	7.5			7.5			10,5	
	Maximum water flow	m ³ /h	4.0			3.8			5.5	
	Maximum power input	W	60			75			140	
	Piping	Water inlet	(in.)	G 1"					G 1-1/2"	
		Water outlet	(in.)	G 1"					G 1-1/2"	
		Inlet/outlet distance	mm	130					180	
Water electric heater	Material	- Stainless steel (Immersion heating element)								
	Power supply	- 1~ 230V 50Hz - 3N~ 400V 50Hz								
	Maximum electric heater power	kW	3.0			6.0			9.0	
	Regulated electric heater power (step 1/ step 2/ step 3)	kW	1.0 / 2.0 / 3.0			2.0 / 4.0 / 6.0			3.0 / 6.0 / 9.0	
	Capillary thermostat	- Yes (Cut-out: 90 °C)								
	Surface thermostat	- Manual reset, Non-adjustable (one per unit) 75°C±5%								
Expansion vessel	Material	- Steel (with stainless/galvanized steel connections)								
	Internal volume	L	6.0					10.0		
	Working pressure	bar	3.0							
	Pre-loading pressure (Air side)	bar	1.0							
Water strainer	Type	- Isolated water strainer (Filter ball)								
	Material	- Brass								
	Piping connection	(in.)	Inlet: 1" DN32; Outlet: 1" DN32							
	Mesh (hole size)	mm	0.7							
	Self-cleaning filter	- Yes								
Safety valve	- Yes (3 bar)									
Water pressure sensor	- Yes (from 0,5 bar up to 3 bar)									
Shut-off valve	- Yes (2 factory-supplied valves)									
Air purger	- Yes (x2)									
Manometer	- Yes									
Unit controller	- Yes (PC-ARFH2E)									

2.5.2.2 YUTAKI S COMBI

◆ Standard model and UK market model

Model			RWD-2.0RW1E-220S(-K)	RWD-2.5RW1E-220S(-K)	RWD-3.0RW1E-220S(-K)	RWD-4.0NW1E-220S(-K)	RWD-5.0NW1E-220S(-K)	RWD-6.0NW1E-220S(-K)	
Domesfic hot water tank	Casing material		Stainless steel						
	Tank	Nominal water volume	L	220					
		Net water volume	L	215					
		Material	-	Duplex UNS 32205 (1.4462)					
		Max. water temperature	°C	75					
		Max. water pressure	bar	10					
		Max. heating coil water temperature	°C	75					
		Max. heating coil water pressure	bar	3					
	Tank insulation	Material	-	Neopor					
		Thickness	mm	50					
	Heat exchanger	Quantity	-	1					
		Coil surface area	m ²	1.60					
		Internal coil volume	L	7.2					
	Tank's heater	Quantity	-	1					
		Type	-	Immersion heater type					
Heater rating		kW	2.7						
Mechanical thermostat (adjustable and security)		-	Yes (adjustable 28~80°C ; cut-out: 95°C)						
Water heat exchanger	Type	-	Brazed plate						
	Material	-	Stainless steel						
	Transfer fluids	-	R32 - H ₂ O			R410A - H ₂ O			
	Quantity	-	1						
	Internal refrigerant volume	L	0.54	0.73	0.81	1.55	2.09	2.09	
	Internal volume	L	0.57	0.76	0.84	1.64	2.18	2.18	
	Insulation material	-	NBR + PVC						
Water pump	Model	-	UPM3 K 15-75 130 AZA 6 HIT			UPM3L K 15-75 130 AZA 6 HIT			
	Type	-	Inverter						
	Control	-	PWM						
	Power supply	-	1~ 230V 50Hz						
	Maximum lift pressure	mwp	7.5			7.5			
	Maximum water flow	m ³ /h	4.0			3.8			
	Maximum power input	W	60			75			
	Piping	Water inlet	(in.)	G 1"					
		Water outlet	(in.)	G 1"					
Inlet/outlet distance		mm	130						
Water electric heater	Material	-	Stainless steel (Immersion heating element)						
	Power supply	-	1~ 230V 50Hz / 3N~ 400V 50Hz						
	Maximum electric heater power	kW	3.0			6.0			
	Capillary thermostat		Manual reset, Non-adjustable (one per unit) 75°C±5%						
	Regulated electric heater power (step 1/ step 2/ step 3)	kW	1.0/2.0/3.0			2.0/4.0/6.0			
	Thermostat security	-	Yes (Cut-out: 90 °C)						

Model		RWD- 2.0RW1E- 220S(-K)	RWD- 2.5RW1E- 220S(-K)	RWD- 3.0RW1E- 220S(-K)	RWD- 4.0NW1E- 220S(-K)	RWD- 5.0NW1E- 220S(-K)	RWD- 6.0NW1E- 220S(-K)
Expansion vessel	Material	-	Steel (with stainless/galvanized steel connections)				
	Internal volume	L	6.0				
	Working pressure	bar	3.0				
	Pre-loading pressure (Air side)	bar	1.0				
Water strainer	Type	-	Isolated water strainer (Filter ball)				
	Material	-	Brass				
	Piping connection	(in.)	Inlet: Quick connections; Outlet: 1" DN32				
	Mesh (hole size)	mm	0.7				
	Self-cleaning (with back flush) filter	-	Yes				
DHW Pressure and temperature relief valve (1)	bar	-	7				
	°C	-	96				
Safety valve	-	Yes (3 bar)					
Water pressure sensor	-	Yes (from 0,5 bar up to 3 bar)					
Unit drain port	-	Yes					
DHW drain valve	-	Yes					
Shut-off valve	-	Yes (2 factory-supplied valves)					
Air purger	-	Yes (x2)					
Manometer	-	Yes					
Unit controller	-	Yes (PC-ARFH2E)					

(1) Only for UK version.

2.6 Electrical data

2.6.1 Considerations

Key words:

- U: Power supply.
- PH: Phase.
- IPT: Total input power.
- STC: Starting current: Less than maximum current.
- RNC: Running current.
- MC: Maximum current.



NOTE

- Heating conditions: Inlet/outlet water temperature: 30/35 °C ; Outdoor ambient temperature (DB/WB): 7/6 °C
- The compressor data shown in the tables below are based on a combined capacity of 100% of the power supplied.
- The "Maximum current" shown in the above table is the maximum total unit running current at the following conditions:
 - Supply voltage: 90% of the rated voltage.
 - Unit capacity: 100% at maximum operating conditions.
- The power supply cables must be sized to cover this maximum current value.
- Specifications in these tables are subject to change without notice in order that Hitachi may bring the latest innovations to their customers.

2.6.2 Split system - Outdoor unit

RAS-(2-3)WHVRP1 / RAS-(4-10)WH(V)NPE in combination with YUTAKI S, YUTAKI S COMBI

Model	Power supply	Applicable voltage		Compressor and fan motors					MC (A)	Max. IPT (kW)
		U max. (V)	U min. (V)	STC (A)	Cooling		Heating			
					RNC (A)	IPT (KW)	RNC (A)	IPT (KW)		
RAS-2WHVRP1	1~ 230V 50Hz	253	207	-	4.5	1.00	5.0	1.09	10.4	2.27
RAS-2.5WHVRP1					5.0	1.12	5.5	1.19	12.9	2.82
RAS-3WHVRP1					7.6	1.67	8.1	1.79	15.8	3.49
RAS-4WHVNPE					9.2	2.11	9.3	2.12	30	6.93
RAS-5WHVNPE					12.6	2.87	12.7	2.90	30	6.93
RAS-6WHVNPE					16.0	3.65	15.0	3.43	30	6.93
RAS-4WHNPE	3N~ 400V 50Hz	440	360	-	3.4	2.11	3.4	2.12	14	8.70
RAS-5WHNPE					4.6	2.87	4.6	2.90	14	8.70
RAS-6WHNPE					5.8	3.65	5.5	3.43	16	9.95
RAS-8WHNPE					7.1	4.41	7.3	4.58	24	15.00
RAS-10WHNPE					9.8	6.15	8.8	5.51	24	15.00

2.6.3 Split system - Indoor unit

2.6.3.1 YUTAKI S

RWM-(2.0-10.0)(N/R)1E

Model	Power supply	Applicable voltage		Operation mode	RNC (A)	IPT (kW)	MC (A)	Max. IPT (kW)
		U max. (V)	U min. (V)					
RWM-2.0R1E	1~ 230V 50Hz	253	207	Without electric heater	0.5	0.06	0.63	0.06
				With electric heater	13.7	3.06	13.7	3.06
				With DHW tank heater	13.7	3.06	13.7	3.06
				With electric and DHW tank heaters	26.7	6.06	26.7	6.06
	3N~ 400V 50Hz	440	360	Without electric heater	0.5	0.06	0.6	0.06
				With electric heater	4.8	3.06	5.0	3.06
				With DHW tank heater	4.5	3.06	13.7	3.06
				With electric and DHW tank heaters	8.9	6.06	18.0	6.06
RWM-(2.5-3.0)R1E	1~ 230V 50Hz	253	207	Without electric heater	0.6	0.06	0.6	0.06
				With electric heater	13.7	3.06	13.7	3.06
				With DHW tank heater	13.7	3.06	13.7	3.06
				With electric and DHW tank heaters	26.7	6.06	26.7	6.06
	3N~ 400V 50Hz	440	360	Without electric heater	0.6	0.06	0.6	0.06
				With electric heater	4.8	3.06	5.0	3.06
				With DHW tank heater	4.5	3.06	13.7	3.06
				With electric and DHW tank heaters	8.9	6.06	18.0	6.06
RWM-(4.0-6.0)N1E	1~ 230V 50Hz	253	207	Without electric heater	0.6	0.08	0.7	0.08
				With electric heater	26.7	6.08	26.7	6.08
				With DHW tank heater	13.7	3.08	13.7	3.08
				With electric and DHW tank heaters	39.8	9.08	39.8	9.08
	3N~ 400V 50Hz	440	360	Without electric heater	0.6	0.08	0.7	0.08
				With electric heater	9.1	6.08	9.3	6.08
				With DHW tank heater	4.5	3.08	13.7	3.08
				With electric and DHW tank heaters	13.3	9.08	22.4	9.08
RWM-(8.0-10.0)N1E	3N~ 400V 50Hz	440	360	Without electric heater	0.3	0.08	0.6	0.14
				With electric heater	13.1	9.08	13.6	9.14
				With DHW tank heater	4.4	3.08	13.7	3.14
				With electric and DHW tank heaters	17.4	12.08	26.6	12.14

NOTE

The data corresponding to DHW tank heater is calculated in combination with the domestic hot water tank accessory "DHWT-(200/300) S-3.0H2E".

2.6.3.2 YUTAKI S COMBI**RWD-(2.0-6.0)(N/R)W1E-220S(-K)**

Model	Power supply	Applicable voltage		Operation mode	RNC (A)	IPT (kW)	MC (A)	Max. IPT (kW)
		U max. (V)	U min. (V)					
RWD-2.0RW1E-220S(-K)	1~ 230V 50Hz	253	207	Without electric heater	0.5	0.06	0.63	0.06
				With electric heater	13.7	3.06	13.7	3.06
				With DHW tank heater	12.6	2.81	12.6	2.81
				With electric and DHW tank heaters	25.6	5.81	25.6	5.81
	3N~ 400V 50Hz	440	360	Without electric heater	0.5	0.06	0.63	0.06
				With electric heater	8.7	3.06	9.3	3.06
				With DHW tank heater	12.5	2.81	12.6	2.81
				With electric and DHW tank heaters	12.5	5.81	12.6	5.81
RWD-(2.5-3.0)RW1E-220S(-K)	1~ 230V 50Hz	253	207	Without electric heater	0.6	0.06	0.63	0.06
				With electric heater	13.7	3.06	13.7	3.06
				With DHW tank heater	12.6	2.81	12.6	2.81
				With electric and DHW tank heaters	25.6	5.81	25.6	5.81
	3N~ 400V 50Hz	440	360	Without electric heater	0.6	0.06	0.63	0.06
				With electric heater	8.7	3.06	9.3	3.06
				With DHW tank heater	12.5	2.81	12.6	2.81
				With electric and DHW tank heaters	12.5	5.81	12.6	5.81
RWD-(4.0-6.0)NW1E-220S(-K)	1~ 230V 50Hz	253	207	Without electric heater	0.6	0.08	0.65	0.08
				With electric heater	26.7	6.08	26.7	6.08
				With DHW tank heater	12.6	2.83	12.6	2.83
				With electric and DHW tank heaters	38.7	8.83	38.7	8.83
	3N~ 400V 50Hz	440	360	Without electric heater	0.6	0.08	0.65	0.08
				With electric heater	17.4	6.08	18.0	6.08
				With DHW tank heater	12.6	2.83	12.6	2.83
				With electric and DHW tank heaters	17.4	8.83	18.0	8.83

3. Capacity and selection data

Index

3.1	YUTAKI S	60
3.1.1	Maximum heating capacity table (kW) (Integrated) (Standard Humidity).....	60
3.1.2	Maximum heating capacity table (kW) (Integrated) (High Humidity condition) (Only for RAS-(2-3)WHVRP1 outdoor combination models).....	62
3.1.3	Maximum cooling capacity table (kW).....	63
3.2	YUTAKI S COMBI	65
3.2.1	Maximum heating capacity table (kW) (Integrated) (Standard Humidity).....	65
3.2.2	Maximum heating capacity table (kW) (Integrated) (High Humidity condition) (Only for RAS-(2-3)WHVRP1 outdoor combination models).....	66
3.2.3	Maximum cooling capacity table (kW)	67
3.3	Correction factors	68
3.3.1	Piping length correction factor.....	68
3.3.2	Correction factor depending on the altitude	71

3.1 YUTAKI S

3.1.1 Maximum heating capacity table (kW) (Integrated) (Standard Humidity)

System	Water outlet temp (°C)	Ambient temperature (°C WB)																			
		-20		-15		-10		-7		-2		2		7		12		15		20	
		CAP (kW)	IPT (kW)	CAP (kW)	IPT (kW)	CAP (kW)	IPT (kW)	CAP (kW)	IPT (kW)	CAP (kW)	IPT (kW)	CAP (kW)	IPT (kW)	CAP (kW)	IPT (kW)	CAP (kW)	IPT (kW)	CAP (kW)	IPT (kW)	CAP (kW)	IPT (kW)
RAS-2WHVRP1 + RWM-2.0R1E	60	-	-	-	-	-	-	3.20	2.29	3.64	2.25	4.00	2.22	5.00	2.17	5.50	1.77	5.66	1.71	5.93	1.61
	55	-	-	-	-	4.00	2.42	4.20	2.27	4.48	2.25	4.70	2.24	6.00	2.22	6.30	1.80	6.46	1.68	6.73	1.48
	50	-	-	-	-	4.36	2.32	4.60	2.22	4.85	2.13	5.05	2.05	6.15	2.01	6.65	1.71	6.85	1.61	7.17	1.43
	45	4.00	2.35	4.25	2.30	4.72	2.22	5.00	2.17	5.22	2.00	5.40	1.86	6.30	1.80	7.00	1.63	7.23	1.54	7.62	1.38
	40	4.15	2.34	4.54	2.24	4.93	2.14	5.17	2.08	5.32	1.86	5.45	1.70	6.40	1.59	7.25	1.48	7.48	1.42	7.87	1.31
	35	4.30	2.32	4.50	2.14	5.02	2.04	5.33	1.98	5.42	1.73	5.49	1.53	6.50	1.38	7.50	1.34	7.73	1.30	8.12	1.24
	30	4.50	2.23	4.80	2.09	5.31	1.93	5.62	1.83	5.69	1.65	5.75	1.50	6.70	1.34	7.75	1.30	7.98	1.27	8.37	1.20
	25	4.70	2.14	5.10	2.04	5.60	1.82	5.90	1.68	5.95	1.56	6.00	1.46	6.90	1.30	8.00	1.27	8.23	1.23	8.62	1.16
20	4.90	2.04	5.40	1.99	5.89	1.71	6.18	1.54	6.22	1.48	6.25	1.43	7.10	1.26	8.25	1.24	8.48	1.19	8.87	1.12	
RAS-2.5WHVRP1 + RWM-2.5R1E	60	-	-	-	-	-	-	4.00	3.33	4.72	3.27	5.30	3.21	6.20	2.58	6.50	2.24	6.66	2.25	6.93	2.27
	55	-	-	-	-	4.70	3.13	5.00	2.94	5.44	2.81	5.80	2.70	7.00	2.64	7.50	2.42	7.73	2.34	8.12	2.21
	50	-	-	-	-	5.10	2.97	5.40	2.85	5.90	2.74	6.30	2.66	7.48	2.60	8.00	2.27	8.31	2.22	8.83	2.14
	45	4.60	2.86	5.00	2.86	5.50	2.80	5.80	2.76	6.36	2.68	6.80	2.62	7.97	2.57	8.50	2.12	8.62	2.01	8.81	1.82
	40	4.80	2.77	5.27	2.77	5.73	2.71	6.01	2.67	6.51	2.54	6.90	2.44	8.28	2.28	8.85	1.95	9.00	1.84	9.25	1.66
	35	5.00	2.77	5.40	2.77	5.92	2.65	6.23	2.58	6.66	2.40	7.00	2.26	8.60	2.00	9.20	1.77	9.39	1.67	9.70	1.50
	30	5.25	2.72	5.70	2.72	6.12	2.53	6.36	2.41	6.82	2.25	7.18	2.12	8.85	1.93	9.50	1.67	9.63	1.59	9.84	1.44
	25	5.50	2.67	6.00	2.67	6.31	2.40	6.50	2.24	6.97	2.10	7.35	1.99	9.10	1.86	9.80	1.58	9.87	1.50	9.98	1.38
20	5.75	2.57	6.30	2.57	6.51	2.32	6.63	2.17	7.13	2.00	7.52	1.87	9.35	1.79	10.10	1.49	10.11	1.42	10.13	1.31	
RAS-3WHVRP1 + RWM-3.0R1E	60	-	-	-	-	-	-	5.10	3.64	5.77	3.46	6.31	3.32	7.50	3.21	8.00	2.76	8.12	2.73	8.31	2.70
	55	-	-	-	-	5.30	3.53	5.50	3.44	6.42	3.42	7.15	3.40	9.00	3.30	9.80	3.11	9.85	3.07	9.92	3.01
	50	-	-	-	-	5.80	3.39	6.08	3.31	6.83	3.24	7.43	3.18	9.15	3.08	9.90	2.91	10.03	2.88	10.24	2.83
	45	5.25	3.39	5.70	3.35	6.30	3.24	6.67	3.18	7.24	3.06	7.70	2.96	9.30	2.86	10.00	2.70	10.21	2.68	10.55	2.66
	40	5.63	3.36	6.19	3.27	6.75	3.17	7.08	3.12	7.64	2.96	8.09	2.83	10.15	2.77	10.75	2.60	10.88	2.59	11.09	2.56
	35	6.00	3.33	6.25	3.29	7.03	3.14	7.50	3.06	8.04	2.85	8.47	2.69	10.99	2.68	11.50	2.50	11.55	2.49	11.62	2.46
	30	6.25	3.29	6.52	3.23	7.23	3.08	7.65	3.00	8.36	2.77	8.94	2.58	11.15	2.57	11.65	2.32	11.70	2.30	11.77	2.26
	25	6.50	3.25	6.80	3.16	7.42	3.02	7.80	2.94	8.69	2.68	9.40	2.48	11.30	2.46	11.80	2.15	11.85	2.11	11.92	2.06
20	6.75	3.21	7.08	3.10	7.62	2.97	7.94	2.88	9.09	2.62	10.00	2.40	11.50	2.40	12.00	2.00	12.16	1.97	12.43	1.92	
RAS-4WH(V)NPE + RWM-4.0N1E	60	-	-	-	-	6.50	4.33	6.80	4.12	6.91	3.60	7.00	3.18	8.50	3.40	10.20	3.64	11.22	3.79	13.00	4.06
	55	-	-	-	-	7.20	4.30	9.70	5.56	9.90	4.86	10.50	4.47	13.50	4.75	14.36	4.69	14.77	4.62	15.46	4.50
	50	-	-	7.50	4.17	7.79	3.95	9.87	4.50	10.00	4.16	10.90	4.19	13.88	4.33	14.83	4.21	15.39	4.14	16.34	4.05
	45	7.20	4.03	8.28	4.05	9.35	4.07	10.00	4.08	10.60	3.95	11.50	3.97	14.10	3.85	15.30	3.73	16.02	3.66	17.00	3.54
	40	8.10	4.16	8.95	4.12	9.80	4.07	10.31	4.05	11.00	3.93	11.80	3.92	14.65	3.56	15.65	3.40	16.25	3.31	17.25	3.15
	35	9.00	4.29	9.62	4.18	10.25	4.08	10.62	4.01	11.83	4.08	12.80	4.13	15.20	3.27	16.00	3.08	16.48	2.96	17.50	2.81
	30	10.00	4.34	10.77	4.22	11.53	4.10	11.99	4.03	12.72	3.90	13.30	3.80	15.90	3.31	16.60	2.81	17.02	2.51	17.72	2.60
	25	11.64	4.44	12.16	4.31	12.68	4.18	13.00	4.10	13.72	3.98	13.58	3.61	16.10	2.82	17.00	2.74	17.54	2.69	18.44	2.55
20	13.28	4.55	13.56	4.40	13.84	4.26	14.00	4.18	14.72	4.06	13.78	3.46	16.30	2.34	17.40	2.67	18.06	2.87	19.16	2.50	
RAS-5WH(V)NPE + RWM-5.0N1E	60	-	-	-	-	7.47	5.45	8.19	5.97	8.16	5.27	8.14	4.72	11.20	5.62	11.40	5.33	12.00	5.43	14.00	6.08
	55	-	-	-	-	9.22	6.36	11.20	6.22	12.21	6.24	12.96	6.22	15.20	6.30	16.00	5.71	16.50	5.37	16.70	5.20
	50	-	-	9.30	6.00	9.99	5.81	11.42	5.87	12.45	5.64	13.27	5.45	15.46	5.41	16.50	4.93	16.80	4.55	17.10	4.16
	45	8.10	4.54	9.43	4.90	10.76	5.27	11.60	5.50	12.68	5.04	13.59	4.69	15.70	4.53	17.00	4.15	17.50	3.86	18.00	3.70
	40	8.90	4.61	10.02	4.81	11.15	5.00	11.82	5.12	12.89	4.75	13.75	4.45	16.13	4.10	17.15	3.77	17.70	3.56	18.50	3.62
	35	9.70	4.69	10.62	4.71	11.53	4.74	12.00	4.72	13.10	4.46	13.90	4.21	16.70	3.70	17.30	3.39	17.80	3.24	18.80	3.55
	30	10.70	4.74	11.28	4.55	11.85	4.35	12.20	4.24	13.26	4.18	14.10	4.14	17.20	3.58	17.90	3.03	17.96	2.63	19.10	3.38
	25	11.16	4.42	12.25	4.42	13.34	4.42	14.00	4.42	14.70	4.32	15.27	4.24	17.90	3.51	18.50	3.08	18.80	2.82	19.50	3.13
20	11.61	4.10	13.22	4.30	14.83	4.49	15.80	4.60	16.15	4.46	16.43	4.34	18.10	3.33	18.80	3.08	19.00	2.90	20.00	2.71	

System	Water outlet temp (°C)	Ambient temperature (°C WB)																			
		-20		-15		-10		-7		-2		2		7		12		15		20	
		CAP (kW)	IPT (kW)	CAP (kW)	IPT (kW)	CAP (kW)	IPT (kW)	CAP (kW)	IPT (kW)	CAP (kW)	IPT (kW)	CAP (kW)	IPT (kW)	CAP (kW)	IPT (kW)	CAP (kW)	IPT (kW)	CAP (kW)	IPT (kW)	CAP (kW)	IPT (kW)
RAS-6WH(V)NPE + RWM-6.0N1E	60	-	-	-	-	7.80	5.57	8.30	5.72	9.02	5.35	9.60	5.05	12.00	5.71	12.10	5.50	13.00	5.75	15.00	6.37
	55	-	-	-	-	10.38	7.39	12.00	7.18	12.96	7.09	13.96	7.16	17.00	7.13	17.20	6.14	17.30	5.98	17.40	5.70
	50	-	-	10.1	6.97	10.77	6.39	11.83	6.32	12.98	6.19	13.90	6.09	17.10	6.19	17.30	5.92	17.50	5.77	18.00	5.56
	45	9.00	4.86	10.32	5.34	11.63	5.81	12.50	6.13	13.56	5.68	14.48	5.36	17.30	5.33	17.50	4.49	18.00	4.14	18.60	3.51
	40	9.55	5.12	10.75	5.33	11.95	5.54	12.67	5.66	13.81	5.31	14.73	5.02	17.55	4.69	18.10	4.12	18.30	3.76	19.00	3.24
	35	10.10	5.37	11.18	5.32	12.27	5.26	13.00	5.27	14.06	4.93	15.00	4.69	17.80	4.05	18.20	3.64	18.60	3.54	19.60	3.43
	30	10.71	4.56	12.57	4.84	13.99	4.93	14.83	4.99	15.12	4.72	15.35	4.51	18.10	3.77	18.60	3.15	19.10	3.14	20.00	3.13
	25	11.30	4.48	12.83	4.63	14.02	4.64	14.73	4.65	15.18	4.47	15.54	4.33	18.50	3.78	19.90	3.37	20.50	3.27	21.00	3.05
	20	12.13	4.48	13.09	4.42	14.05	4.36	14.63	4.32	15.24	4.22	15.72	4.15	18.90	3.78	20.90	3.54	21.10	3.31	22.00	3.04
RAS-8WHNPE + RWM-8.0N1E	60	-	-	-	-	11.92	9.47	13.14	9.00	14.98	9.45	16.45	9.81	21.15	12.41	22.00	10.61	22.50	8.56	23.50	5.60
	55	-	-	-	-	12.79	8.88	14.50	9.67	15.30	8.15	15.95	6.93	24.00	9.60	24.50	9.07	24.80	8.37	25.10	7.13
	50	-	-	12.0	8.60	13.65	8.28	15.70	9.58	16.75	8.97	17.58	8.48	24.01	10.45	24.90	9.31	25.50	7.83	26.10	5.59
	45	10.28	7.73	12.71	8.12	15.14	8.51	16.60	8.74	17.66	7.69	18.50	6.85	25.00	7.94	26.00	7.65	26.50	6.97	26.90	5.85
	40	12.20	8.54	13.31	7.82	15.77	8.04	17.24	8.17	18.36	7.39	19.25	6.76	25.25	7.41	26.30	6.98	26.90	6.76	27.10	6.25
	35	14.00	9.15	14.50	7.84	16.39	7.57	17.90	7.61	19.06	7.08	20.00	6.67	25.50	6.89	26.50	6.31	27.10	6.00	27.90	5.53
	30	14.80	8.60	14.27	7.12	16.97	7.51	18.58	7.74	19.38	6.80	20.02	6.04	26.50	6.97	27.00	6.28	27.60	6.02	28.10	5.53
	25	15.90	7.81	16.20	7.19	17.22	7.12	19.11	7.66	19.96	6.78	20.64	6.07	27.10	6.95	27.50	6.11	28.00	5.78	28.50	5.23
	20	16.00	6.22	16.50	6.38	17.47	6.74	19.64	7.57	20.55	6.76	21.27	6.11	27.70	6.92	28.00	5.95	28.50	5.57	29.00	4.97
RAS-10WHNPE + RWM-10.0N1E	60	-	-	-	-	13.90	10.69	14.50	8.06	16.17	8.44	17.50	8.75	22.00	9.57	23.50	11.19	24.30	9.17	25.00	5.79
	55	-	-	-	-	15.76	13.87	17.30	12.36	18.61	10.71	19.50	9.29	25.52	10.65	26.00	10.83	26.50	9.58	27.20	7.42
	50	-	-	15.5	12.9	16.37	12.80	18.36	12.84	18.97	10.35	19.46	8.35	28.05	10.64	28.60	10.51	29.00	9.41	29.90	7.63
	45	13.00	8.67	14.81	9.52	17.12	10.71	18.50	11.42	19.89	9.24	21.00	7.50	32.00	10.67	33.00	10.64	33.20	9.78	33.60	8.40
	40	14.20	9.17	15.44	9.10	18.13	9.96	19.74	10.48	20.36	9.04	20.85	7.89	32.00	9.54	33.50	9.47	33.50	9.18	33.80	8.80
	35	15.10	9.44	16.07	8.67	18.50	8.90	21.00	9.55	21.00	8.91	21.70	8.68	32.00	8.42	34.00	8.29	34.70	8.25	34.90	7.97
	30	15.70	8.72	16.01	7.60	18.70	7.91	21.63	8.66	22.95	8.79	24.00	8.89	33.20	8.85	34.30	7.98	35.00	7.99	35.10	7.78
	25	16.40	8.63	16.35	7.41	18.80	7.63	22.03	8.48	23.74	8.90	25.11	9.24	33.50	8.70	34.50	6.90	35.80	7.02	36.20	6.88
	20	17.00	8.47	17.50	7.56	19.00	7.39	22.43	8.30	24.54	9.02	26.00	9.52	33.00	8.35	35.00	6.00	36.10	6.10	37.00	6.14



NOTE

- CAP: Capacity at compressor maximum frequency. Capacity is valid for difference between water inlet and water outlet of 3-8°C.
- IPT: Total input power.

The table above shows the input power (IPT) at maximum capacity (CAP). Most of the time, the unit will run at partial load, so that the actual input power will be lower.

3.1.2 Maximum heating capacity table (kW) (Integrated) (High Humidity condition) (Only for RAS-(2-3)WHVRP1 outdoor combination models)

System	Water outlet temp (°C)	Ambient temperature (°C WB)																					
		-20		-15		-10		-7		-2		2		7		12		15		20		25	
		CAP (kW)	IPT (kW)	CAP (kW)	IPT (kW)	CAP (kW)	IPT (kW)	CAP (kW)	IPT (kW)	CAP (kW)	IPT (kW)	CAP (kW)	IPT (kW)	CAP (kW)	IPT (kW)	CAP (kW)	IPT (kW)	CAP (kW)	IPT (kW)	CAP (kW)	IPT (kW)	CAP (kW)	IPT (kW)
RAS-2WHVRP1 + RWM-2.0R1E	60	-	-	-	-	-	-	2.61	1.99	3.20	2.03	3.68	2.07	4.50	2.04	5.50	1.77	5.66	1.71	5.93	1.61	6.20	1.51
	55	-	-	-	-	3.70	2.24	3.73	2.02	4.09	2.08	4.38	2.13	5.70	2.22	6.30	1.80	6.46	1.68	6.73	1.48	7.00	1.27
	50	-	-	-	-	3.80	2.08	3.97	1.97	4.34	1.95	4.64	1.94	5.84	2.01	6.65	1.71	6.85	1.61	7.17	1.43	7.50	1.25
	45	3.26	1.96	3.41	1.91	3.91	1.92	4.21	1.92	4.60	1.83	4.91	1.75	5.99	1.80	7.00	1.63	7.23	1.54	7.62	1.38	8.00	1.23
	40	3.52	2.00	3.91	1.96	4.30	1.93	4.53	1.90	4.85	1.77	5.11	1.66	5.98	1.61	7.25	1.48	7.48	1.42	7.87	1.31	8.25	1.21
	35	3.78	2.04	3.90	1.94	4.50	1.91	4.85	1.89	5.10	1.71	5.30	1.56	5.98	1.43	7.50	1.34	7.73	1.30	8.12	1.24	8.50	1.18
	30	3.95	1.94	4.16	1.86	4.67	1.77	4.97	1.72	5.35	1.63	5.65	1.56	6.16	1.34	7.75	1.30	7.98	1.27	8.37	1.20	8.75	1.14
	25	4.13	1.84	4.43	1.79	4.84	1.64	5.09	1.55	5.60	1.55	6.00	1.55	6.35	1.25	8.00	1.27	8.23	1.23	8.62	1.16	9.00	1.09
	20	4.30	1.73	4.69	1.71	5.01	1.51	5.21	1.38	5.84	1.47	6.35	1.54	6.53	1.16	8.25	1.24	8.48	1.19	8.87	1.12	9.25	1.05
RAS-2.5WHVRP1 + RWM-2.5R1E	60	-	-	-	-	-	-	2.94	2.61	3.68	2.70	4.26	2.77	5.27	2.20	6.50	2.24	6.66	2.25	6.93	2.27	7.20	2.29
	55	-	-	-	-	3.68	2.37	4.00	2.35	4.52	2.41	4.93	2.46	6.51	2.41	7.50	2.42	7.73	2.34	8.12	2.21	8.50	2.07
	50	-	-	-	-	4.02	2.36	4.35	2.35	4.94	2.32	5.40	2.30	6.77	2.34	8.00	2.27	8.74	2.26	9.96	2.25	8.75	1.85
	45	3.49	2.26	3.80	2.33	4.37	2.34	4.71	2.34	5.35	2.23	5.87	2.14	7.04	2.26	8.50	2.12	8.62	2.01	8.81	1.82	9.00	1.64
	40	3.80	2.32	4.22	2.28	4.64	2.24	4.89	2.21	5.50	2.11	5.99	2.02	7.00	2.05	8.85	1.95	9.00	1.84	9.25	1.66	9.50	1.48
	35	4.10	2.39	4.43	2.28	4.83	2.16	5.07	2.08	5.66	1.99	6.12	1.91	6.97	1.84	9.20	1.77	9.39	1.67	9.70	1.50	10.01	1.33
	30	4.31	2.33	4.68	2.24	4.94	2.05	5.09	1.94	5.81	1.88	6.39	1.84	7.18	1.76	9.50	1.67	9.63	1.59	9.84	1.44	10.05	1.29
	25	4.52	2.26	4.94	2.20	5.04	1.95	5.11	1.80	5.97	1.78	6.66	1.76	7.39	1.67	9.80	1.58	9.87	1.50	9.98	1.38	10.10	1.25
	20	4.73	2.15	5.19	2.11	5.15	1.89	5.13	1.76	6.13	1.73	6.93	1.71	7.60	1.59	10.10	1.49	10.11	1.42	10.13	1.31	10.15	1.20
RAS-3WHVRP1 + RWM-3.0R1E	60	-	-	-	-	-	-	3.38	2.96	4.12	2.85	4.71	2.76	4.88	2.60	8.00	2.76	8.12	2.73	8.31	2.70	8.50	2.66
	55	-	-	-	-	4.15	3.14	4.40	3.14	5.18	3.01	5.80	2.90	7.50	2.78	9.80	3.11	9.85	3.07	9.92	3.01	10.00	2.94
	50	-	-	-	-	4.49	2.85	4.78	2.86	5.46	2.75	6.00	2.67	7.76	2.56	9.90	2.91	10.03	2.88	10.24	2.83	10.45	2.78
	45	3.99	2.85	4.27	2.52	4.83	2.55	5.16	2.57	5.74	2.50	6.20	2.44	8.01	2.35	10.00	2.70	10.21	2.68	10.55	2.66	10.90	2.63
	40	4.27	2.73	4.76	2.63	5.24	2.52	5.53	2.46	6.07	2.41	6.50	2.38	8.52	2.39	10.75	2.60	10.88	2.59	11.09	2.56	11.30	2.53
	35	4.56	2.62	4.90	2.61	5.52	2.45	5.89	2.35	6.40	2.33	6.80	2.32	9.03	2.44	11.50	2.50	11.55	2.49	11.62	2.46	11.70	2.44
	30	4.75	2.58	5.10	2.55	5.56	2.39	5.84	2.29	6.66	2.30	7.31	2.30	9.14	2.34	11.65	2.32	11.70	2.30	11.77	2.26	11.85	2.22
	25	4.94	2.55	5.30	2.50	5.61	2.33	5.79	2.23	6.92	2.26	7.82	2.28	9.25	2.23	11.80	2.15	11.85	2.11	11.92	2.06	12.00	2.00
	20	5.13	2.52	5.51	2.44	5.65	2.27	5.74	2.17	8.11	2.30	10.00	2.40	11.50	2.40	12.00	2.00	12.16	1.97	12.43	1.92	12.70	1.87

3.1.3 Maximum cooling capacity table (kW)

System	Water outlet temperature (°C)	Ambient temperature (°C DB)															
		10		15		20		25		30		35		40		45	
		CAP (kW)	IPT (kW)	CAP (kW)	IPT (kW)	CAP (kW)	IPT (kW)	CAP (kW)	IPT (kW)	CAP (kW)	IPT (kW)	CAP (kW)	IPT (kW)	CAP (kW)	IPT (kW)	CAP (kW)	IPT (kW)
RAS-2WHVRP1 + RWM-2.0R1E	22	-	-	-	-	-	-	7.40	0.95	6.93	1.03	6.45	1.11	5.98	1.19	5.50	1.26
	18	-	-	-	-	7.50	0.88	7.10	0.97	6.80	1.08	6.40	1.21	5.75	1.27	5.10	1.32
	15	7.00	0.97	6.92	0.99	6.83	1.00	6.75	1.01	6.27	1.10	5.79	1.19	5.31	1.29	4.83	1.38
	10	6.80	0.97	6.58	1.01	6.37	1.04	6.15	1.08	5.71	1.17	5.26	1.27	4.82	1.37	4.37	1.47
	7	6.20	0.98	6.10	1.03	6.00	1.07	5.80	1.12	5.40	1.23	5.00	1.33	4.55	1.43	4.10	1.52
	5	-	-	5.50	1.08	5.20	1.17	4.90	1.26	4.60	1.34	4.30	1.43	4.00	1.52	3.70	1.61
RAS-2.5WHVRP1 + RWM-2.5R1E	22	-	-	-	-	-	-	8.70	1.19	8.10	1.27	7.50	1.35	6.90	1.42	6.30	1.50
	18	-	-	-	-	8.50	1.21	8.30	1.24	7.90	1.36	7.20	1.48	6.60	1.58	6.00	1.67
	15	8.10	1.25	8.03	1.26	7.96	1.27	7.89	1.28	7.35	1.39	6.81	1.50	6.27	1.61	5.73	1.72
	10	7.60	1.25	7.47	1.28	7.34	1.31	7.21	1.35	6.73	1.46	6.24	1.57	5.76	1.69	5.27	1.80
	7	7.10	1.13	7.20	1.16	7.30	1.20	6.80	1.39	6.30	1.58	6.00	1.74	5.50	1.80	5.00	1.85
	5	-	-	6.80	1.36	6.43	1.49	6.07	1.62	5.70	1.75	5.33	1.88	4.97	2.01	4.60	2.14
RAS-3WHVRP1 + RWM-3.0R1E	22	-	-	-	-	-	-	10.50	1.67	9.90	1.73	9.30	1.80	8.70	1.86	8.10	1.93
	18	-	-	-	-	10.60	1.64	10.20	1.71	9.50	1.84	9.00	1.94	8.00	1.98	7.00	2.03
	15	9.50	1.40	9.52	1.54	9.53	1.68	9.55	1.82	8.84	1.90	8.14	1.98	7.43	2.06	6.73	2.14
	10	8.80	1.44	8.68	1.63	8.57	1.81	8.45	2.00	7.91	2.08	7.36	2.17	6.82	2.25	6.27	2.33
	7	8.10	1.56	8.00	1.74	7.90	1.93	7.80	2.11	7.60	2.08	7.00	2.19	6.50	2.32	6.00	2.45
	5	-	-	8.00	1.74	7.68	1.86	7.35	1.99	7.03	2.11	6.70	2.23	6.15	2.45	5.60	2.67
RAS-4WH(V)NPE + RWM-4.0N1E	22	-	-	-	-	-	-	16.10	2.64	15.66	3.10	15.22	3.57	14.78	4.03	14.34	4.49
	18	-	-	-	-	17.00	2.93	16.10	2.85	15.50	3.60	15.00	4.00	14.35	4.45	13.70	4.89
	15	16.00	2.71	15.77	2.79	15.54	2.87	15.31	2.95	14.65	3.45	13.99	3.95	13.33	4.45	12.66	4.95
	10	15.10	2.75	14.73	2.87	14.36	2.99	13.99	3.12	13.23	3.60	12.46	4.09	11.70	4.57	10.94	5.06
	7	14.00	2.30	13.89	3.43	13.40	2.53	13.20	3.22	12.30	3.57	11.80	4.07	10.85	4.59	9.90	5.12
	5	-	-	13.33	3.81	12.54	4.04	11.76	4.28	10.97	4.51	10.18	4.74	9.39	4.98	8.60	5.21
RAS-5WH(V)NPE + RWM-5.0N1E	22	-	-	-	-	-	-	18.30	3.27	17.98	3.92	17.65	4.56	17.33	5.21	17.00	5.86
	18	-	-	-	-	18.50	3.43	17.60	3.12	17.40	4.05	16.00	4.27	15.00	4.83	14.00	5.38
	15	17.10	3.42	17.09	3.40	17.09	3.38	17.08	3.36	16.07	3.90	15.05	4.43	14.03	4.96	13.02	5.49
	10	16.60	3.32	16.47	3.47	16.35	3.62	16.22	3.78	15.01	4.25	13.80	4.72	12.59	5.20	11.38	5.67
	7	16.10	3.16	15.90	3.25	15.40	3.14	15.70	4.03	13.20	3.83	12.60	4.67	11.50	5.22	10.40	5.78
	5	-	-	15.51	3.10	14.59	3.63	13.67	4.15	12.76	4.68	11.84	5.20	10.92	5.73	10.00	6.25
RAS-6WH(V)NPE + RWM-6.0N1E	22	-	-	-	-	-	-	20.00	4.00	19.63	4.71	19.25	5.43	18.88	6.14	18.50	6.85
	18	-	-	-	-	20.00	3.85	19.00	3.73	17.80	4.45	17.50	4.86	16.65	5.72	15.80	6.58
	15	18.00	4.09	18.10	4.07	18.19	4.05	18.29	4.02	17.34	4.66	16.39	5.29	15.44	5.92	14.49	6.55
	10	17.50	3.89	17.37	4.10	17.24	4.31	17.11	4.52	15.91	5.02	14.71	5.51	13.51	6.01	12.31	6.50
	7	17.00	3.70	16.79	3.73	16.70	4.07	16.40	4.82	14.90	4.32	13.70	5.37	12.35	5.92	11.00	6.47
	5	-	-	16.40	3.49	15.58	4.23	14.77	4.97	13.95	5.71	13.13	6.45	12.32	7.19	11.50	7.93
RAS-8WHNPE + RWM-8.0N1E	22	-	-	-	-	-	-	25.80	6.62	25.00	7.05	24.20	7.49	23.40	7.93	22.60	8.37
	18	-	-	-	-	25.10	6.28	24.60	6.65	24.00	7.06	23.50	7.12	22.25	7.76	21.00	8.40
	15	23.20	5.04	22.99	5.43	22.79	5.82	22.58	6.22	21.85	6.79	21.11	7.37	20.37	7.95	19.64	8.53
	10	21.10	5.15	20.47	5.26	19.85	5.38	19.22	5.49	18.75	6.31	18.29	7.12	17.83	7.94	17.36	8.76
	7	20.20	4.93	19.70	4.99	19.20	5.05	17.20	5.06	16.70	5.76	16.40	6.31	16.20	7.60	16.00	8.89
	5	-	-	18.50	4.93	17.83	5.62	17.17	6.31	16.50	7.00	15.83	7.69	15.17	8.37	14.50	9.06



System	Water outlet temperature (°C)	Ambient temperature (°C DB)															
		10		15		20		25		30		35		40		45	
		CAP (kW)	IPT (kW)	CAP (kW)	IPT (kW)	CAP (kW)	IPT (kW)	CAP (kW)	IPT (kW)	CAP (kW)	IPT (kW)	CAP (kW)	IPT (kW)	CAP (kW)	IPT (kW)	CAP (kW)	IPT (kW)
RAS-10WHNPE + RWM-10.0N1E	22	-	-	-	-	-	-	28.60	6.65	27.70	7.39	26.80	8.13	25.90	8.87	25.00	9.62
	18	-	-	-	-	28.50	6.33	28.00	6.67	27.50	7.64	27.00	8.71	25.00	9.35	23.00	10.00
	15	26.00	6.67	26.07	6.69	26.13	6.71	26.20	6.73	25.06	7.63	23.92	8.54	22.78	9.44	21.64	10.34
	10	25.30	6.66	24.60	6.72	23.90	6.78	23.20	6.84	22.24	7.86	21.28	8.87	20.32	9.89	19.36	10.91
	7	24.00	6.49	23.40	6.50	22.80	6.51	21.40	6.90	21.00	7.78	20.60	8.96	19.30	10.10	18.00	11.25
	5	-	-	21.00	6.36	20.33	7.19	19.67	8.02	19.00	8.85	18.33	9.68	17.67	10.51	17.00	11.33

**NOTE**

CAP: Capacity at compressor maximum frequency. Capacity is valid for difference between water inlet and water outlet of 3-8°C.

3.2 YUTAKI S COMBI

3.2.1 Maximum heating capacity table (kW) (Integrated) (Standard Humidity)

System	Water outlet temp (°C)	Ambient temperature (°C WB)																			
		-20		-15		-10		-7		-2		2		7		12		15		20	
		CAP (kW)	IPT (kW)	CAP (kW)	IPT (kW)	CAP (kW)	IPT (kW)	CAP (kW)	IPT (kW)	CAP (kW)	IPT (kW)	CAP (kW)	IPT (kW)	CAP (kW)	IPT (kW)	CAP (kW)	IPT (kW)	CAP (kW)	IPT (kW)	CAP (kW)	IPT (kW)
RAS-2WHVRP1+ RWD-2.0RW1E-220S(-K)	60	-	-	-	-	-	-	3.20	2.29	3.64	2.25	4.00	2.22	5.00	2.17	5.50	1.77	5.66	1.71	5.93	1.61
	55	-	-	-	-	4.00	2.42	4.20	2.27	4.48	2.25	4.70	2.24	6.00	2.22	6.30	1.80	6.46	1.68	6.73	1.48
	50	-	-	-	-	4.36	2.32	4.60	2.22	4.85	2.13	5.05	2.05	6.15	2.01	6.65	1.71	6.85	1.61	7.17	1.43
	45	4.00	2.35	4.25	2.30	4.72	2.22	5.00	2.17	5.22	2.00	5.40	1.86	6.30	1.80	7.00	1.63	7.23	1.54	7.62	1.38
	40	4.15	2.34	4.54	2.24	4.93	2.14	5.17	2.08	5.32	1.86	5.45	1.70	6.40	1.59	7.25	1.48	7.48	1.42	7.87	1.31
	35	4.30	2.32	4.50	2.14	5.02	2.04	5.33	1.98	5.42	1.73	5.49	1.53	6.50	1.38	7.50	1.34	7.73	1.30	8.12	1.24
	30	4.50	2.23	4.80	2.09	5.31	1.93	5.62	1.83	5.69	1.65	5.75	1.50	6.70	1.34	7.75	1.30	7.98	1.27	8.37	1.20
	25	4.70	2.14	5.10	2.04	5.60	1.82	5.90	1.68	5.95	1.56	6.00	1.46	6.90	1.30	8.00	1.27	8.23	1.23	8.62	1.16
20	4.90	2.04	5.40	1.99	5.89	1.71	6.18	1.54	6.22	1.48	6.25	1.43	7.10	1.26	8.25	1.24	8.48	1.19	8.87	1.12	
RAS-2.5WHVRP1 + RWD-2.5RW1E-220S(-K)	60	-	-	-	-	-	-	4.00	3.33	4.72	3.27	5.30	3.21	6.20	2.58	6.50	2.24	6.66	2.25	6.93	2.27
	55	-	-	-	-	4.70	3.13	5.00	2.94	5.44	2.81	5.80	2.70	7.00	2.64	7.50	2.42	7.73	2.34	8.12	2.21
	50	-	-	-	-	5.10	2.97	5.40	2.85	5.90	2.74	6.30	2.66	7.48	2.60	8.00	2.27	8.31	2.22	8.83	2.14
	45	4.60	2.86	5.00	2.86	5.50	2.80	5.80	2.76	6.36	2.68	6.80	2.62	7.97	2.57	8.50	2.12	8.62	2.01	8.81	1.82
	40	4.80	2.77	5.27	2.77	5.73	2.71	6.01	2.67	6.51	2.54	6.90	2.44	8.28	2.28	8.85	1.95	9.00	1.84	9.25	1.66
	35	5.00	2.77	5.40	2.77	5.92	2.65	6.23	2.58	6.66	2.40	7.00	2.26	8.60	2.00	9.20	1.77	9.39	1.67	9.70	1.50
	30	5.25	2.72	5.70	2.72	6.12	2.53	6.36	2.41	6.82	2.25	7.18	2.12	8.85	1.93	9.50	1.67	9.63	1.59	9.84	1.44
	25	5.50	2.67	6.00	2.67	6.31	2.40	6.50	2.24	6.97	2.10	7.35	1.99	9.10	1.86	9.80	1.58	9.87	1.50	9.98	1.38
20	5.75	2.57	6.30	2.57	6.51	2.32	6.63	2.17	7.13	2.00	7.52	1.87	9.35	1.79	10.10	1.49	10.11	1.42	10.13	1.31	
RAS-3WHVRP1 + RWD-3.0RW1E-220S(-K)	60	-	-	-	-	-	-	5.10	3.64	5.77	3.46	6.31	3.32	7.50	3.21	8.00	2.76	8.12	2.73	8.31	2.70
	55	-	-	-	-	5.30	3.53	5.50	3.44	6.42	3.42	7.15	3.40	9.00	3.30	9.80	3.11	9.85	3.07	9.92	3.01
	50	-	-	-	-	5.80	3.39	6.08	3.31	6.83	3.24	7.43	3.18	9.15	3.08	9.90	2.91	10.03	2.88	10.24	2.83
	45	5.25	3.39	5.70	3.35	6.30	3.24	6.67	3.18	7.24	3.06	7.70	2.96	9.30	2.86	10.00	2.70	10.21	2.68	10.55	2.66
	40	5.63	3.36	6.19	3.27	6.75	3.17	7.08	3.12	7.64	2.96	8.09	2.83	10.15	2.77	10.75	2.60	10.88	2.59	11.09	2.56
	35	6.00	3.33	6.25	3.29	7.03	3.14	7.50	3.06	8.04	2.85	8.47	2.69	10.99	2.68	11.50	2.50	11.55	2.49	11.62	2.46
	30	6.25	3.29	6.52	3.23	7.23	3.08	7.65	3.00	8.36	2.77	8.94	2.58	11.15	2.57	11.65	2.32	11.70	2.30	11.77	2.26
	25	6.50	3.25	6.80	3.16	7.42	3.02	7.80	2.94	8.69	2.68	9.40	2.48	11.30	2.46	11.80	2.15	11.85	2.11	11.92	2.06
20	6.75	3.21	7.08	3.10	7.62	2.97	7.94	2.88	9.09	2.62	10.00	2.40	11.50	2.40	12.00	2.00	12.16	1.97	12.43	1.92	
RAS-4WH(V)NPE + RWD-4.0NW1E-220S(-K)	60	-	-	-	-	6.50	4.33	6.80	4.12	6.91	3.60	7.00	3.18	8.50	3.40	10.20	3.64	11.22	3.79	13.00	4.06
	55	-	-	-	-	7.20	4.30	9.70	5.56	9.90	4.86	10.50	4.47	13.50	4.75	14.36	5.16	14.77	5.37	15.46	3.50
	50	-	-	7.50	4.17	7.79	3.95	9.87	4.50	10.00	4.16	10.90	4.19	13.88	4.33	14.83	4.45	15.39	4.51	16.34	4.63
	45	7.20	4.03	8.28	4.05	9.35	4.07	10.00	4.08	10.60	3.95	11.50	3.97	14.10	3.85	15.30	3.73	16.02	3.66	17.00	3.49
	40	8.10	4.16	8.95	4.12	9.80	4.07	10.31	4.05	11.00	3.93	11.80	3.92	14.65	3.56	15.65	3.40	16.25	3.31	17.25	3.15
	35	9.00	4.29	9.62	4.18	10.25	4.08	10.62	4.01	11.83	4.08	12.80	4.13	15.20	3.27	16.00	3.08	16.48	2.96	17.50	2.81
	30	10.00	4.34	10.77	4.22	11.53	4.10	11.99	4.03	12.72	3.90	13.30	3.80	15.90	3.31	16.60	2.81	17.02	2.51	17.72	2.60
	25	11.64	4.44	12.16	4.31	12.68	4.18	13.00	4.10	13.72	3.98	13.58	3.61	16.10	2.82	17.00	2.74	17.54	2.69	18.44	2.55
20	13.28	4.55	13.56	4.40	13.84	4.26	14.00	4.18	14.72	4.06	13.78	3.46	16.30	2.34	17.40	2.67	18.06	2.87	19.16	2.50	
RAS-5WH(V)NPE + RWD-5.0NW1E-220S(-K)	60	-	-	-	-	7.47	5.45	8.19	5.97	8.16	5.27	8.14	4.72	11.20	5.62	11.40	5.33	12.00	5.43	14.00	6.08
	55	-	-	-	-	9.22	6.36	11.20	6.22	12.21	6.24	12.96	6.22	15.20	6.30	16.00	5.71	16.50	5.37	16.70	3.86
	50	-	-	9.30	6.00	9.99	5.81	11.42	5.87	12.45	5.64	13.27	5.45	15.46	5.41	16.50	4.93	16.80	4.55	17.10	3.92
	45	8.10	4.54	9.43	4.90	10.76	5.27	11.60	5.50	12.68	5.04	13.59	4.69	15.70	4.53	17.00	4.15	17.50	3.86	18.00	3.51
	40	8.90	4.61	10.02	4.81	11.15	5.00	11.82	5.12	12.89	4.75	13.75	4.45	16.13	4.10	17.15	3.77	17.70	3.56	18.50	3.19
	35	9.70	4.69	10.62	4.71	11.53	4.74	12.00	4.72	13.10	4.46	13.90	4.21	16.70	3.70	17.30	3.39	17.80	3.24	18.80	3.55
	30	10.70	4.74	11.28	4.55	11.85	4.35	12.20	4.24	13.26	4.18	14.10	4.14	17.20	3.58	17.90	3.03	17.96	2.63	19.10	3.38
	25	11.16	4.42	12.25	4.42	13.34	4.42	14.00	4.42	14.70	4.32	15.27	4.24	17.90	3.51	18.50	3.08	18.80	2.82	19.50	3.13
20	11.61	4.10	13.22	4.30	14.83	4.49	15.80	4.60	16.15	4.46	16.43	4.34	18.10	3.33	18.80	3.08	19.00	2.90	20.00	2.71	



System	Water outlet temp (°C)	Ambient temperature (°C WB)																			
		-20		-15		-10		-7		-2		2		7		12		15		20	
		CAP (kW)	IPT (kW)	CAP (kW)	IPT (kW)	CAP (kW)	IPT (kW)	CAP (kW)	IPT (kW)	CAP (kW)	IPT (kW)	CAP (kW)	IPT (kW)	CAP (kW)	IPT (kW)	CAP (kW)	IPT (kW)	CAP (kW)	IPT (kW)	CAP (kW)	IPT (kW)
RAS-6WH(V)NPE + RWD-6.0NW1E-220S(-K)	60	-	-	-	-	7.80	5.57	8.30	5.72	9.02	5.35	9.60	5.05	12.00	5.71	12.10	5.50	13.00	5.75	15.00	6.37
	55	-	-	-	-	10.38	7.39	12.00	7.18	12.96	7.09	13.96	7.16	17.00	7.13	17.20	6.14	17.30	5.56	17.40	4.60
	50	-	-	10.1	6.97	10.77	6.39	11.83	6.32	12.98	6.19	13.90	6.09	17.10	6.19	17.30	5.92	17.50	5.77	18.00	5.56
	45	9.00	4.86	10.32	5.34	11.63	5.81	12.50	6.13	13.56	5.68	14.48	5.36	17.30	5.33	17.50	4.49	18.00	4.14	18.60	3.51
	40	9.55	5.12	10.75	5.33	11.95	5.54	12.67	5.66	13.81	5.31	14.73	5.02	17.55	4.69	18.10	4.12	18.30	3.76	19.00	3.24
	35	10.10	5.37	11.18	5.32	12.27	5.26	13.00	5.27	14.06	4.93	15.00	4.69	17.80	4.05	18.20	3.64	18.60	3.54	19.60	3.43
	30	10.71	4.56	12.57	4.84	13.99	4.93	14.83	4.99	15.12	4.72	15.35	4.51	18.10	3.77	18.60	3.15	19.10	3.14	20.00	3.13
	25	11.30	4.48	12.83	4.63	14.02	4.64	14.73	4.65	15.18	4.47	15.54	4.33	18.50	3.78	19.90	3.37	20.50	3.27	21.00	3.05
	20	12.13	4.48	13.09	4.42	14.05	4.36	14.63	4.32	15.24	4.22	15.72	4.15	18.90	3.78	20.90	3.54	21.10	3.31	22.00	3.04

NOTE

- CAP: Capacity at compressor maximum frequency. Capacity is valid for difference between water inlet and water outlet of 3-8°C.
 - IPT: Total input power.
- The table above shows the input power (IPT) at maximum capacity (CAP). Most of the time, the unit will run at partial load, so that the actual input power will be lower.

3.2.2 Maximum heating capacity table (kW) (Integrated) (High Humidity condition) (Only for RAS-(2-3)WHVRP1 outdoor combination models)

System	Water outlet temp (°C)	Ambient temperature (°C WB)																							
		-20		-15		-10		-7		-2		2		7		12		15		20		25			
		CAP (kW)	IPT (kW)	CAP (kW)	IPT (kW)	CAP (kW)	IPT (kW)	CAP (kW)	IPT (kW)	CAP (kW)	IPT (kW)	CAP (kW)	IPT (kW)	CAP (kW)	IPT (kW)	CAP (kW)	IPT (kW)	CAP (kW)	IPT (kW)	CAP (kW)	IPT (kW)	CAP (kW)	IPT (kW)		
RAS-2WHVRP1 + RWD-2.0RW1E-220S(-K)	60	-	-	-	-	-	-	2.61	1.99	3.20	2.03	3.68	2.07	4.50	2.04	5.50	1.77	5.66	1.71	5.93	1.61	6.20	1.51		
	55	-	-	-	-	3.70	2.24	3.73	2.02	4.09	2.08	4.38	2.13	5.70	2.22	6.30	1.80	6.46	1.68	6.73	1.48	7.00	1.27		
	50	-	-	-	-	3.80	2.08	3.97	1.97	4.34	1.95	4.64	1.94	5.84	2.01	6.65	1.71	6.85	1.61	7.17	1.43	7.50	1.25		
	45	3.26	1.96	3.41	1.91	3.91	1.92	4.21	1.92	4.60	1.83	4.91	1.75	5.99	1.80	7.00	1.63	7.23	1.54	7.62	1.38	8.00	1.23		
	40	3.52	2.00	3.91	1.96	4.30	1.93	4.53	1.90	4.85	1.77	5.11	1.66	5.98	1.61	7.25	1.48	7.48	1.42	7.87	1.31	8.25	1.21		
	35	3.78	2.04	3.90	1.94	4.50	1.91	4.85	1.89	5.10	1.71	5.30	1.56	5.98	1.43	7.50	1.34	7.73	1.30	8.12	1.24	8.50	1.18		
	30	3.95	1.94	4.16	1.86	4.67	1.77	4.97	1.72	5.35	1.63	5.65	1.56	6.16	1.34	7.75	1.30	7.98	1.27	8.37	1.20	8.75	1.14		
	25	4.13	1.84	4.43	1.79	4.84	1.64	5.09	1.55	5.60	1.55	6.00	1.55	6.35	1.25	8.00	1.27	8.23	1.23	8.62	1.16	9.00	1.09		
	20	4.30	1.73	4.69	1.71	5.01	1.51	5.21	1.38	5.84	1.47	6.35	1.54	6.53	1.16	8.25	1.24	8.48	1.19	8.87	1.12	9.25	1.05		
RAS-2.5WHVRP1 + RWD-2.5RW1E-220S(-K)	60	-	-	-	-	-	-	2.94	2.61	3.68	2.70	4.26	2.77	5.27	2.20	6.50	2.24	6.66	2.25	6.93	2.27	7.20	2.29		
	55	-	-	-	-	3.68	2.37	4.00	2.35	4.52	2.41	4.93	2.46	6.51	2.41	7.50	2.42	7.73	2.34	8.12	2.21	8.50	2.07		
	50	-	-	-	-	4.02	2.36	4.35	2.35	4.94	2.32	5.40	2.30	6.77	2.34	8.00	2.27	8.74	2.26	9.96	2.25	8.75	1.85		
	45	3.49	2.26	3.80	2.33	4.37	2.34	4.71	2.34	5.35	2.23	5.87	2.14	7.04	2.26	8.50	2.12	8.62	2.01	8.81	1.82	9.00	1.64		
	40	3.80	2.32	4.22	2.28	4.64	2.24	4.89	2.21	5.50	2.11	5.99	2.02	7.00	2.05	8.85	1.95	9.00	1.84	9.25	1.66	9.50	1.48		
	35	4.10	2.39	4.43	2.28	4.83	2.16	5.07	2.08	5.66	1.99	6.12	1.91	6.97	1.84	9.20	1.77	9.39	1.67	9.70	1.50	10.01	1.33		
	30	4.31	2.33	4.68	2.24	4.94	2.05	5.09	1.94	5.81	1.88	6.39	1.84	7.18	1.76	9.50	1.67	9.63	1.59	9.84	1.44	10.05	1.29		
	25	4.52	2.26	4.94	2.20	5.04	1.95	5.11	1.80	5.97	1.78	6.66	1.76	7.39	1.67	9.80	1.58	9.87	1.50	9.98	1.38	10.10	1.25		
	20	4.73	2.15	5.19	2.11	5.15	1.89	5.13	1.76	6.13	1.73	6.93	1.71	7.60	1.59	10.10	1.49	10.11	1.42	10.13	1.31	10.15	1.20		
RAS-3WHVRP1 + RWD-3.0RW1E-220S(-K)	60	-	-	-	-	-	-	3.38	2.96	4.12	2.85	4.71	2.76	4.88	2.60	8.00	2.76	8.12	2.73	8.31	2.70	8.50	2.66		
	55	-	-	-	-	4.15	3.14	4.40	3.14	5.18	3.01	5.80	2.90	7.50	2.78	9.80	3.11	9.85	3.07	9.92	3.01	10.00	2.94		
	50	-	-	-	-	4.49	2.85	4.78	2.86	5.46	2.75	6.00	2.67	7.76	2.56	9.90	2.91	10.03	2.88	10.24	2.83	10.45	2.78		
	45	3.99	2.85	4.27	2.52	4.83	2.55	5.16	2.57	5.74	2.50	6.20	2.44	8.01	2.35	10.00	2.70	10.21	2.68	10.55	2.66	10.90	2.63		
	40	4.27	2.73	4.76	2.63	5.24	2.52	5.53	2.46	6.07	2.41	6.50	2.38	8.52	2.39	10.75	2.60	10.88	2.59	11.09	2.56	11.30	2.53		
	35	4.56	2.62	4.90	2.61	5.52	2.45	5.89	2.35	6.40	2.33	6.80	2.32	9.03	2.44	11.50	2.50	11.55	2.49	11.62	2.46	11.70	2.44		
	30	4.75	2.58	5.10	2.55	5.56	2.39	5.84	2.29	6.66	2.30	7.31	2.30	9.14	2.34	11.65	2.32	11.70	2.30	11.77	2.26	11.85	2.22		
	25	4.94	2.55	5.30	2.50	5.61	2.33	5.79	2.23	6.92	2.26	7.82	2.28	9.25	2.23	11.80	2.15	11.85	2.11	11.92	2.06	12.00	2.00		
	20	5.13	2.52	5.51	2.44	5.65	2.27	5.74	2.17	8.11	2.30	10.00	2.40	11.50	2.40	12.00	2.00	12.16	1.97	12.43	1.92	12.70	1.87		

3.2.3 Maximum cooling capacity table (kW)

System	Water outlet temperature (°C)	Ambient temperature (°C DB)															
		10		15		20		25		30		35		40		45	
		CAP (kW)	IPT (kW)	CAP (kW)	IPT (kW)	CAP (kW)	IPT (kW)	CAP (kW)	IPT (kW)	CAP (kW)	IPT (kW)	CAP (kW)	IPT (kW)	CAP (kW)	IPT (kW)	CAP (kW)	IPT (kW)
RAS-2WHVRP1 + RWD-2.0RW1E-220S(-K)	22	-	-	-	-	-	-	7.40	0.95	6.93	1.03	6.45	1.11	5.98	1.19	5.50	1.26
	18	-	-	-	-	7.50	0.88	7.10	0.97	6.80	1.08	6.40	1.21	5.75	1.27	5.10	1.32
	15	7.00	0.97	6.92	0.99	6.83	1.00	6.75	1.01	6.27	1.10	5.79	1.19	5.31	1.29	4.83	1.38
	10	6.80	0.97	6.58	1.01	6.37	1.04	6.15	1.08	5.71	1.17	5.26	1.27	4.82	1.37	4.37	1.47
	7	6.20	0.98	6.10	1.03	6.00	1.07	5.80	1.12	5.40	1.23	5.00	1.33	4.55	1.43	4.10	1.52
	5	-	-	5.50	1.08	5.20	1.17	4.90	1.26	4.60	1.34	4.30	1.43	4.00	1.52	3.70	1.61
RAS-2.5WHVRP1 + RWD-2.5RW1E-220S(-K)	22	-	-	-	-	-	-	8.70	1.19	8.10	1.27	7.50	1.35	6.90	1.42	6.30	1.50
	18	-	-	-	-	8.50	1.21	8.30	1.24	7.90	1.36	7.20	1.48	6.60	1.58	6.00	1.67
	15	8.10	1.25	8.03	1.26	7.96	1.27	7.89	1.28	7.35	1.39	6.81	1.50	6.27	1.61	5.73	1.72
	10	7.60	1.25	7.47	1.28	7.34	1.31	7.21	1.35	6.73	1.46	6.24	1.57	5.76	1.69	5.27	1.80
	7	7.10	1.13	7.20	1.16	7.30	1.20	6.80	1.39	6.30	1.58	6.00	1.74	5.50	1.80	5.00	1.85
	5	-	-	6.80	1.36	6.43	1.49	6.07	1.62	5.70	1.75	5.33	1.88	4.97	2.01	4.60	2.14
RAS-3WHVRP1 + RWD-3.0RW1E-220S(-K)	22	-	-	-	-	-	-	10.50	1.67	9.90	1.73	9.30	1.80	8.70	1.86	8.10	1.93
	18	-	-	-	-	10.60	1.64	10.20	1.71	9.50	1.84	9.00	1.94	8.00	1.98	7.00	2.03
	15	9.50	1.40	9.52	1.54	9.53	1.68	9.55	1.82	8.84	1.90	8.14	1.98	7.43	2.06	6.73	2.14
	10	8.80	1.44	8.68	1.63	8.57	1.81	8.45	2.00	7.91	2.08	7.36	2.17	6.82	2.25	6.27	2.33
	7	8.10	1.56	8.00	1.74	7.90	1.93	7.80	2.11	7.60	2.08	7.00	2.19	6.50	2.32	6.00	2.45
	5	-	-	8.00	1.74	7.68	1.86	7.35	1.99	7.03	2.11	6.70	2.23	6.15	2.45	5.60	2.67
RAS-4WH(V)NPE + RWD-4.0NW1E-220S(-K)	22	-	-	-	-	-	-	16.10	2.64	15.66	3.10	15.22	3.57	14.78	4.03	14.34	4.49
	18	-	-	-	-	17.00	2.93	16.10	2.85	15.50	3.60	15.00	4.00	14.35	4.45	13.70	4.89
	15	16.00	2.71	15.77	2.79	15.54	2.87	15.31	2.95	14.65	3.45	13.99	3.95	13.33	4.45	12.66	4.95
	10	15.10	2.75	14.73	2.87	14.36	2.99	13.99	3.12	13.23	3.60	12.46	4.09	11.70	4.57	10.94	5.06
	7	14.00	2.30	13.89	3.43	13.40	2.53	13.20	3.22	12.30	3.57	11.80	4.07	10.85	4.59	9.90	5.12
	5	-	-	13.33	3.81	12.54	4.04	11.76	4.28	10.97	4.51	10.18	4.74	9.39	4.98	8.60	5.21
RAS-5WH(V)NPE + RWD-5.0NW1E-220S(-K)	22	-	-	-	-	-	-	18.30	3.27	17.98	3.92	17.65	4.56	17.33	5.21	17.00	5.86
	18	-	-	-	-	18.50	3.43	17.60	3.12	17.40	4.05	16.00	4.27	15.00	4.83	14.00	5.38
	15	17.10	3.42	17.09	3.40	17.09	3.38	17.08	3.36	16.07	3.90	15.05	4.43	14.03	4.96	13.02	5.49
	10	16.60	3.32	16.47	3.47	16.35	3.62	16.22	3.78	15.01	4.25	13.80	4.72	12.59	5.20	11.38	5.67
	7	16.10	3.16	15.90	3.25	15.40	3.14	15.70	4.03	13.20	3.83	12.60	4.67	11.50	5.22	10.40	5.78
	5	-	-	15.51	3.10	14.59	3.63	13.67	4.15	12.76	4.68	11.84	5.20	10.92	5.73	10.00	6.25
RAS-6WH(V)NPE + RWD-6.0NW1E-220S(-K)	22	-	-	-	-	-	-	20.00	4.00	19.63	4.71	19.25	5.43	18.88	6.14	18.50	6.85
	18	-	-	-	-	20.00	3.85	19.00	3.73	17.80	4.45	17.50	4.86	16.65	5.72	15.80	6.58
	15	18.00	4.09	18.10	4.07	18.19	4.05	18.29	4.02	17.34	4.66	16.39	5.29	15.44	5.92	14.49	6.55
	10	17.50	3.89	17.37	4.10	17.24	4.31	17.11	4.52	15.91	5.02	14.71	5.51	13.51	6.01	12.31	6.50
	7	17.00	3.70	16.79	3.73	16.70	4.07	16.40	4.82	14.90	4.32	13.70	5.37	12.35	5.92	11.00	6.47
	5	-	-	16.40	3.49	15.58	4.23	14.77	4.97	13.95	5.71	13.13	6.45	12.32	7.19	11.50	7.93

 NOTE

CAP: Capacity at compressor maximum frequency. Capacity is valid for difference between water inlet and water outlet of 3-8°C.

3.3 Correction factors

3.3.1 Piping length correction factor

The correction factor is based on the equivalent piping length in metres (EL) and the height difference between outdoor unit and indoor unit in metres (H).

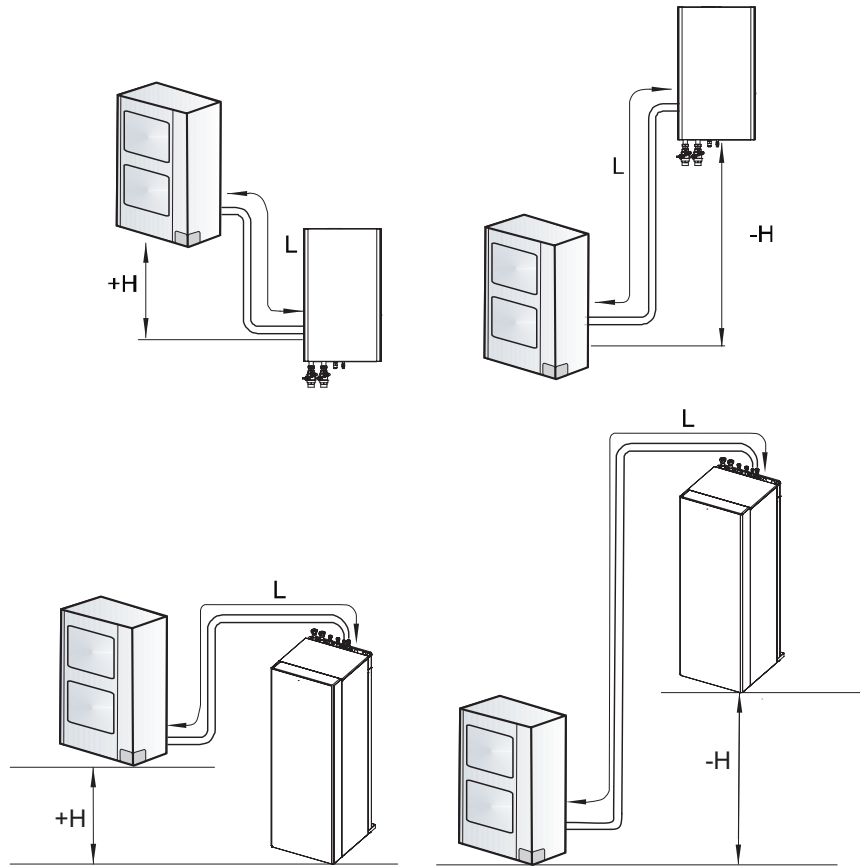

H: Height difference between indoor unit and outdoor unit (m).

- $H > 0$: Outdoor unit is placed higher than indoor unit (m).
- $H < 0$: Outdoor unit is placed lower than indoor unit (m).

L: Actual one-way piping length between indoor unit and outdoor unit (m).

EL: Equivalent one-way piping length between indoor unit and outdoor unit (m).

- One 90° elbow is 0.5 m.
- One 180° bend is 1.5 m.

◆ Heating piping length correction factor

Heating

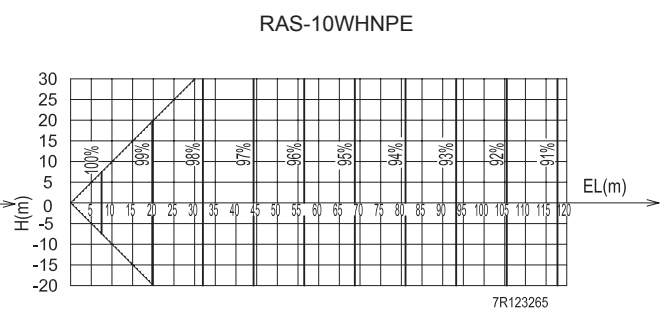
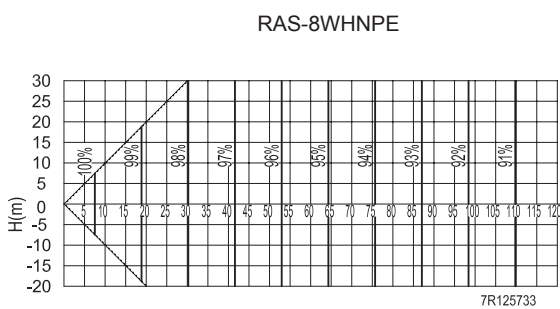
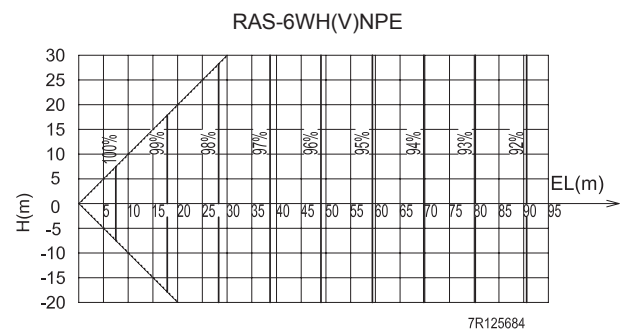
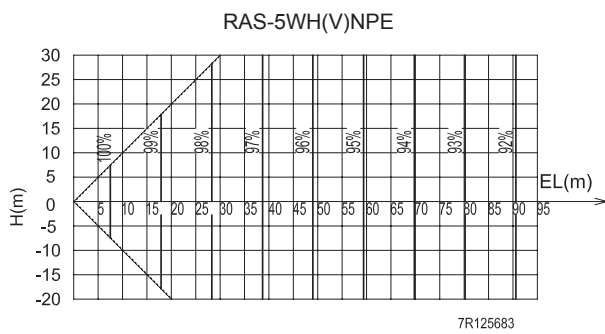
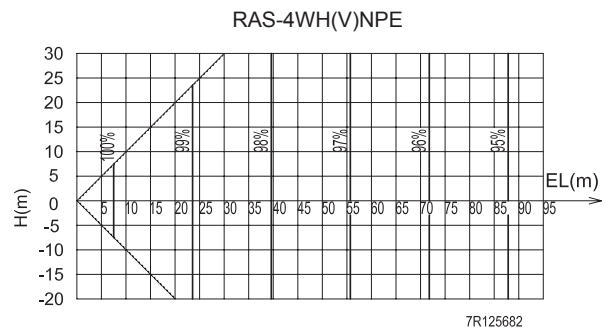
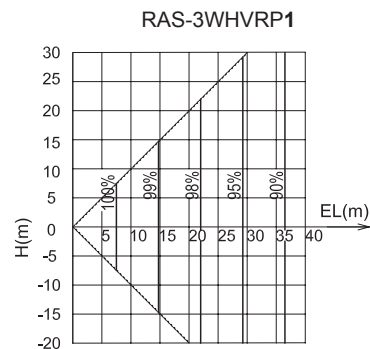
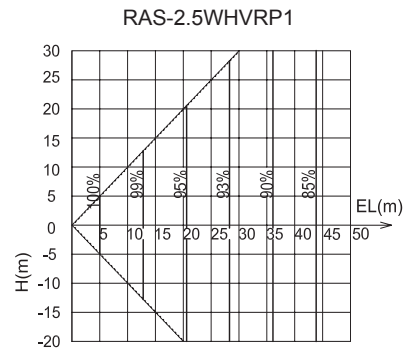
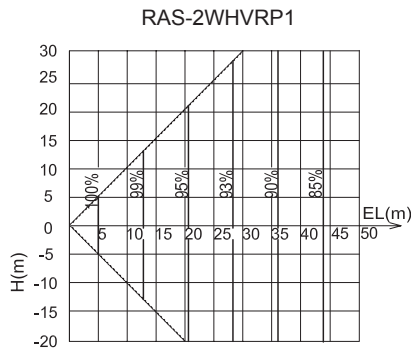

◆ Cooling piping length correction factor

Cooling

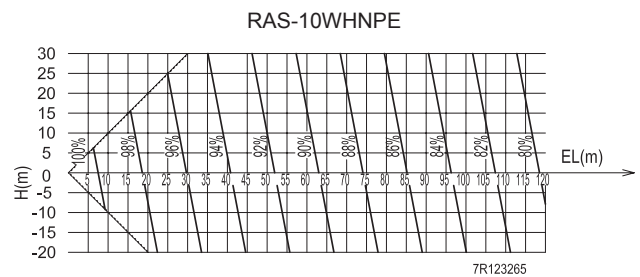
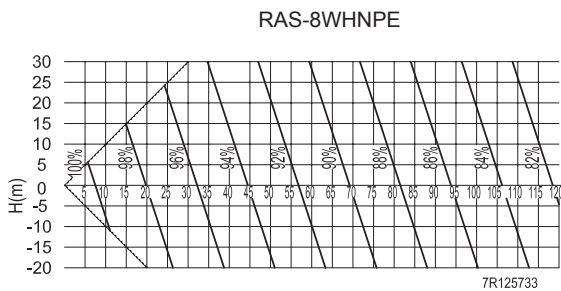
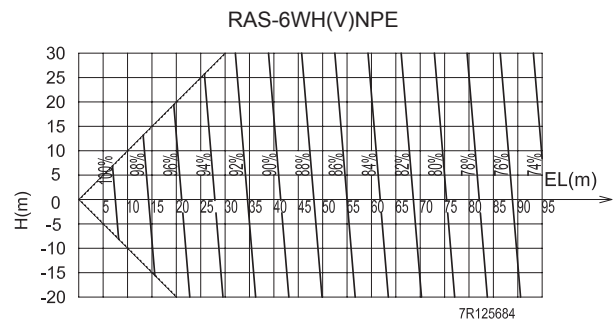
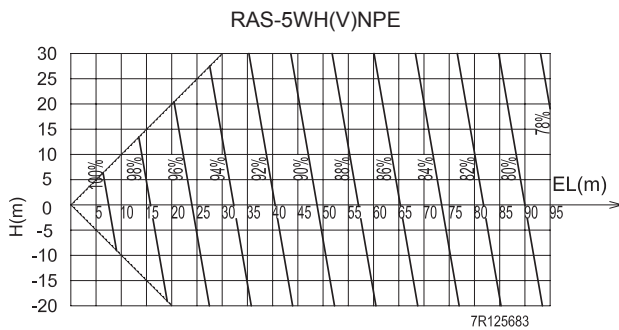
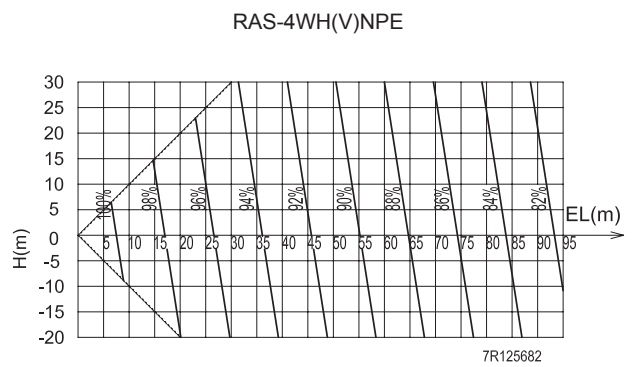
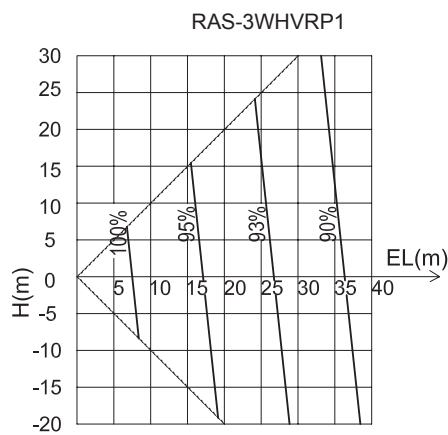
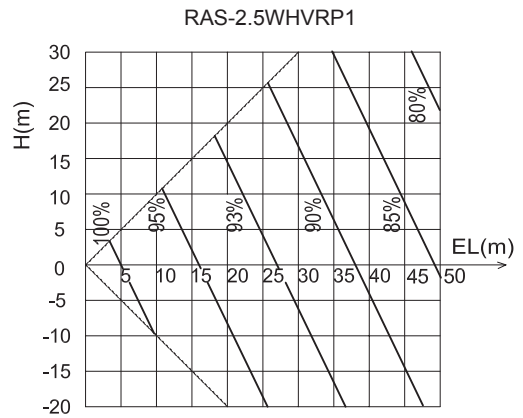
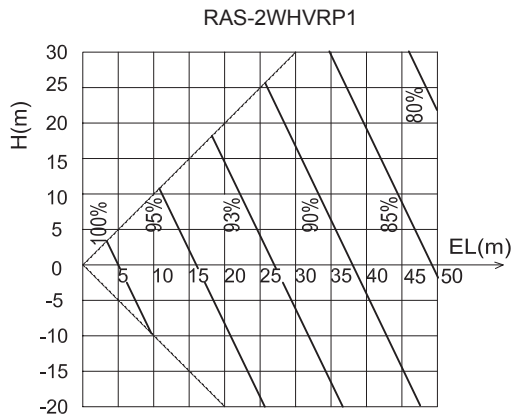

3.3.2 Correction factor depending on the altitude

The capacity must be corrected by the affectations of installation altitude of the installation location. When the altitude is above sea level, capacity must be corrected with the altitude correction factor according to the following equation.

Altitude	m	0	300	600	900	1200	1500	1800	2000
Correction factor		1.00	0.97	0.94	0.90	0.88	0.84	0.81	0.81

Altitude	m	2100	2400	2700	3000	3300	3600	3900	4000
Correction factor		0.78	0.75	0.72	0.69	0.67	0.64	0.62	0.61

4 . Acoustic characteristic curves

Index

4.1	Considerations	74
4.2	Sound pressure level for Outdoor unit.....	75



4.1 Considerations

- 1 Distance of the unit from the measuring point: At 1 meter from the unit's front surface; 1,5 meter from floor level.

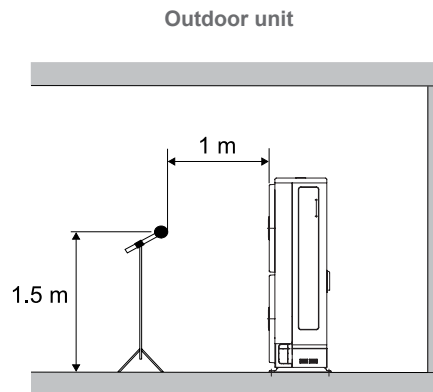

- 2 The data is measured in an anechoic chamber, so reflected sound should be taken into consideration when installing the unit.
- 3 The sound measured with the curve A shown in dB(A) represents the attenuation in function of frequency as perceived by the human ear.
- 4 Reference acoustic pressure 0 dB=20 μ Pa.

4.2 Sound pressure level for Outdoor unit

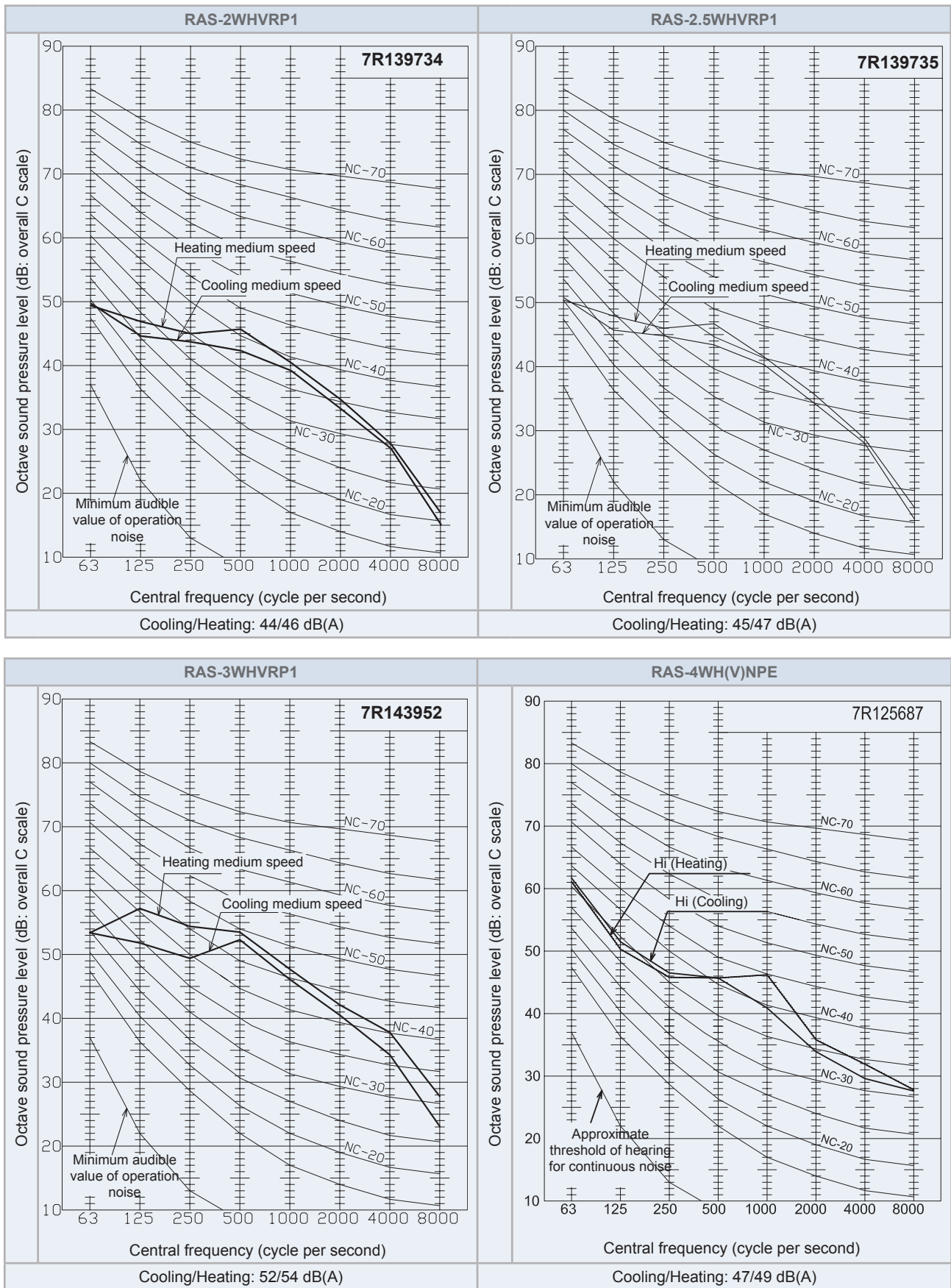

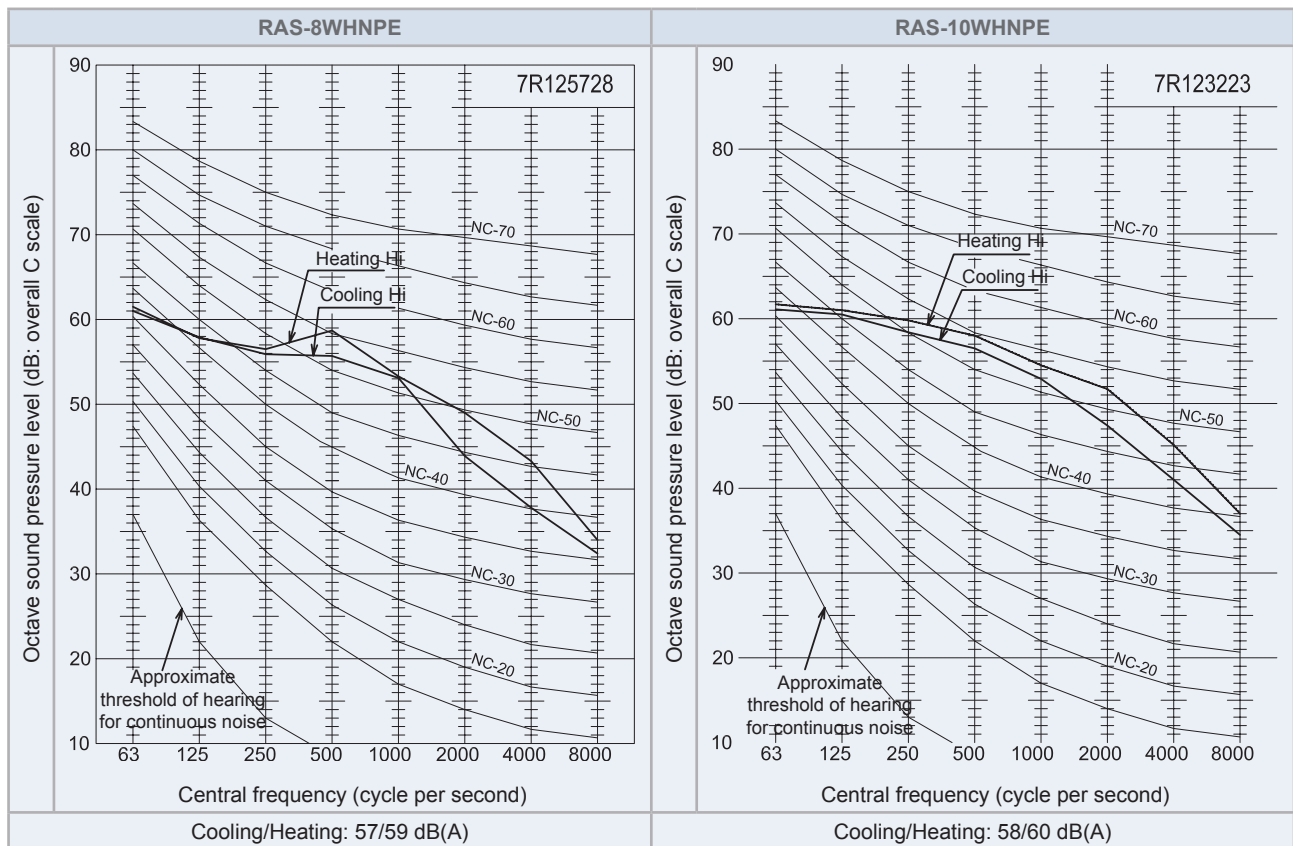
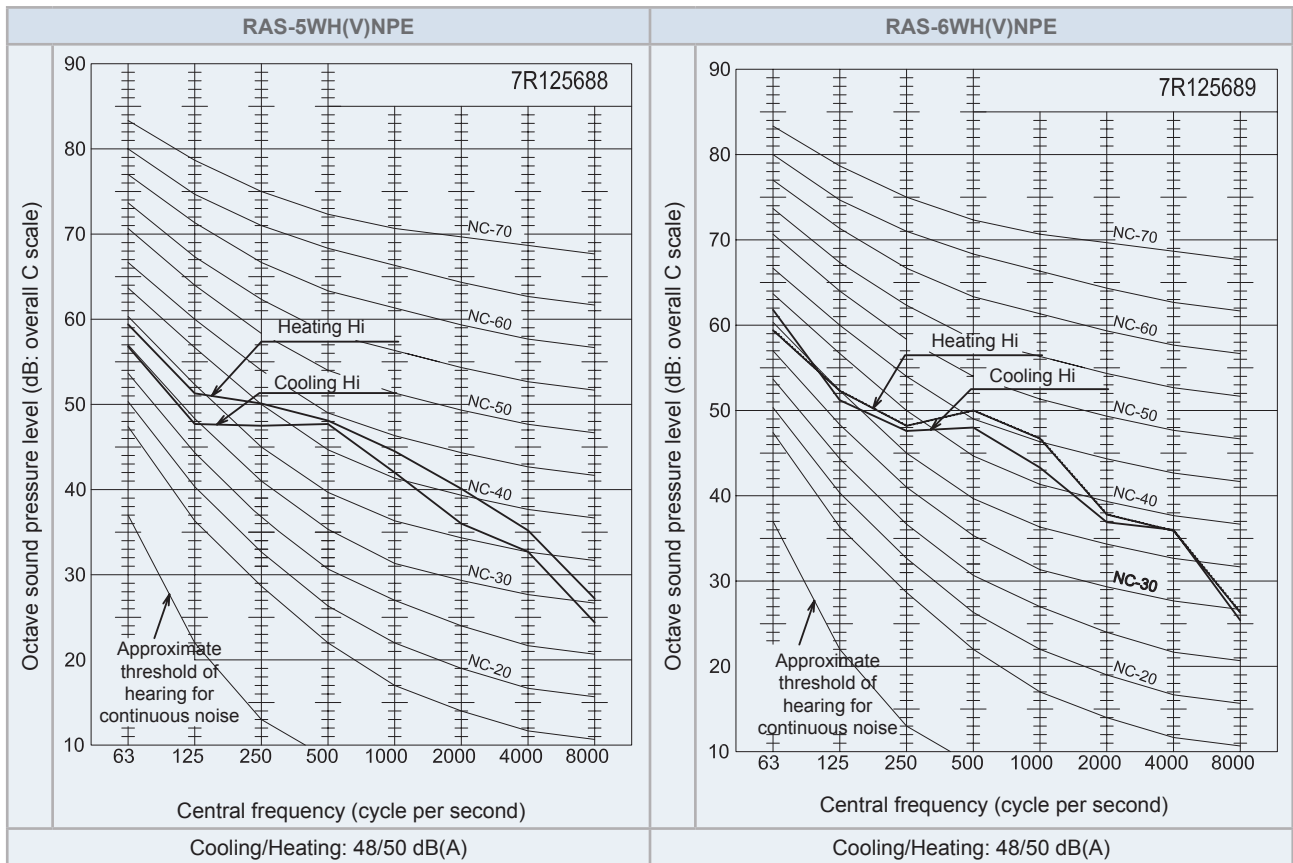

5 . Working range

Index

5.1	Power supply working range	78
5.2	Temperature working range.....	78
5.2.1	Space heating	78
5.2.2	DHW.....	79
5.2.3	Swimming pool heating	80
5.2.4	Space cooling (Necessary cooling kit)	80
5.3	Hydraulic working range.....	81
5.3.1	Hydraulic data	81
5.3.2	Pump performance curves	81

5.1 Power supply working range

◆ Nominal power supply

- Single phase: 1~ 230V 50Hz
- Three phase: 3N~ 400V 50Hz

◆ Operating voltage

Between 90 and 110% of the nominal voltage.

◆ Starting voltage

Always higher than 85% of the nominal voltage.

5.2 Temperature working range

MODEL	2.0HP	2.5HP	3.0HP	4.0HP	5.0HP	6.0HP	8.0HP	10.0HP
Water temperature	Refer to the graphics for each case							
Indoor ambient temperature	5~30							

5.2.1 Space heating

◆ YUTAKI S

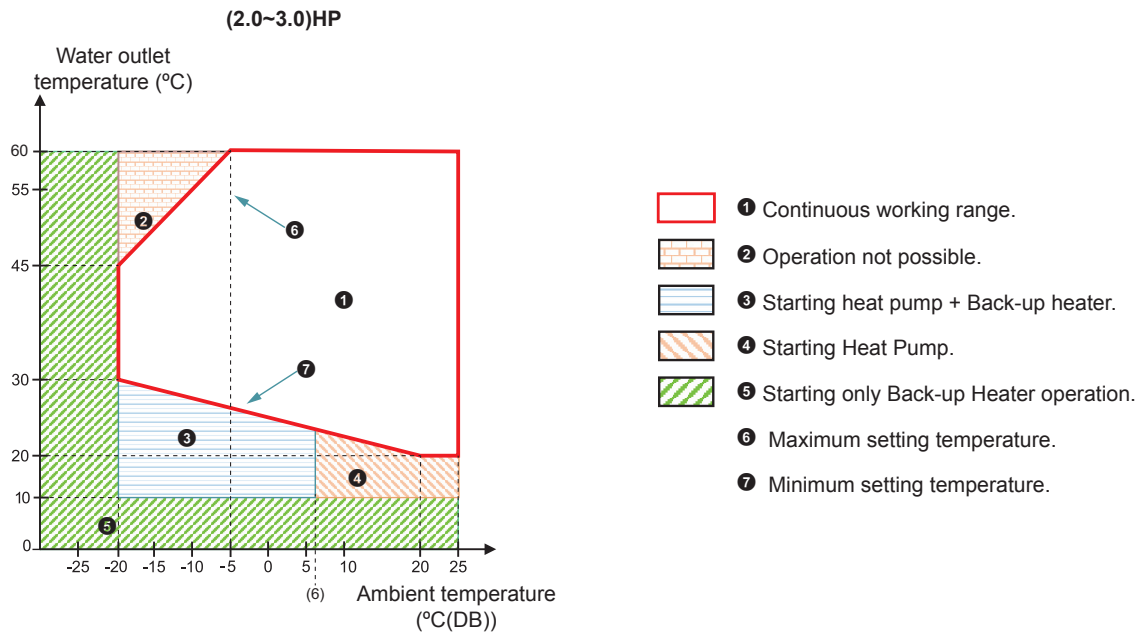

i NOTE

Items ③ and ⑤ only available if back-up heater is enabled.

(4.0-10.0)HP

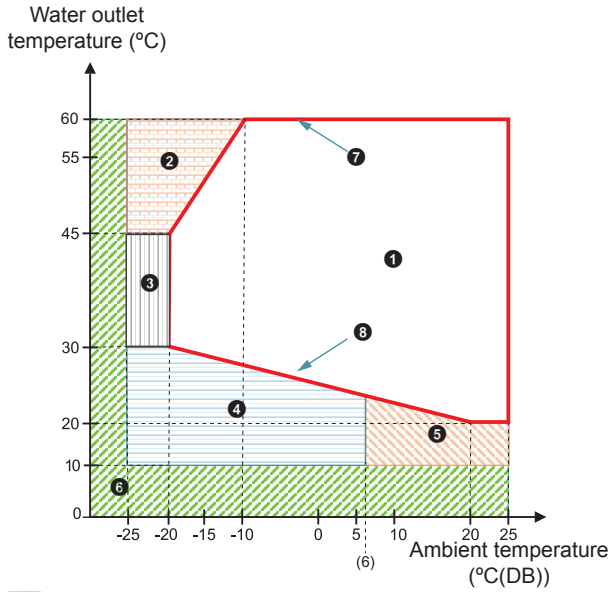

- ① Continuous working range.
- ② Operation not possible.
- ③ Heat Pump operation possible.
- ④ Starting heat pump + Back-up heater.
- ⑤ Starting Heat Pump.
- ⑥ Starting only Back-up Heater operation.
- ⑦ Maximum setting temperature.
- ⑧ Minimum setting temperature.

i NOTE

Items ④ and ⑥ only available if back-up heater is enabled.

5.2.2 DHW

◆ For YUTAKI (S /S COMBI)

(2.0~3.0)HP

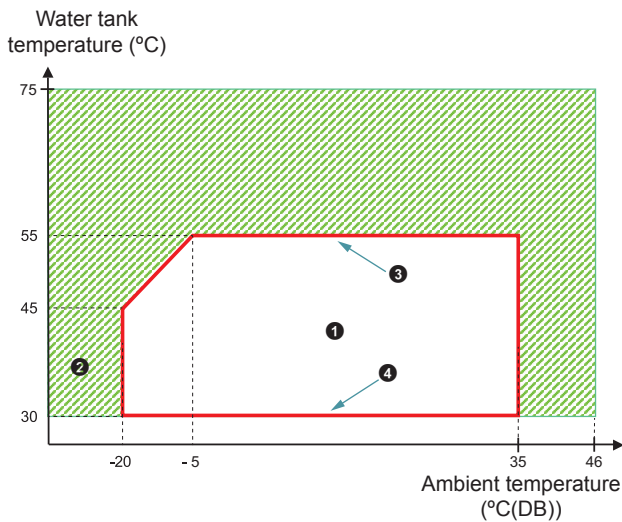

- ① Continuous working range.
- ② Starting only Back-up Heater operation.
- ③ Maximum setting temperature.
- ④ Minimum setting temperature.

i NOTE

In case of heating up the DHW tank with an outdoor ambient temperature lower than -5 °C and without using the DHW electrical heater, the setting temperature must not exceed the maximum value in the specified continuous working range.



(4.0-10.0)HP

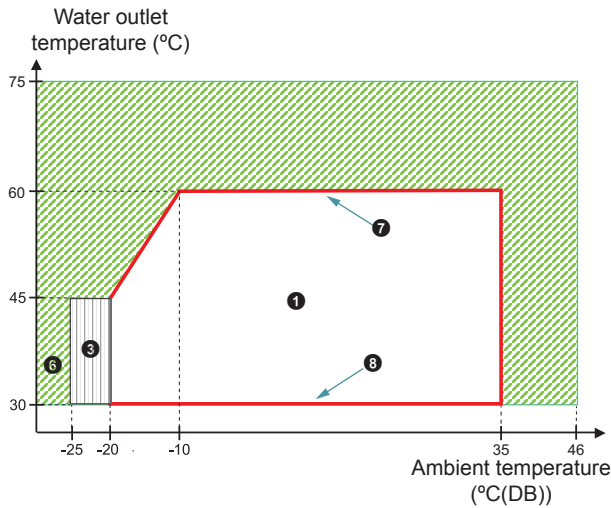

- ① Continuous working range.
- ③ Heat Pump operation possible.
- ⑥ Starting only Back-up Heater operation.
- ⑦ Maximum setting temperature.
- ⑧ Minimum setting temperature.



NOTE

In case of heating up the DHW tank with an outdoor ambient temperature lower than -10 °C and without using the DHW electrical heater, the setting temperature must not exceed the maximum value in the specified continuous working range.

5.2.3 Swimming pool heating

(2.0~3.0)HP

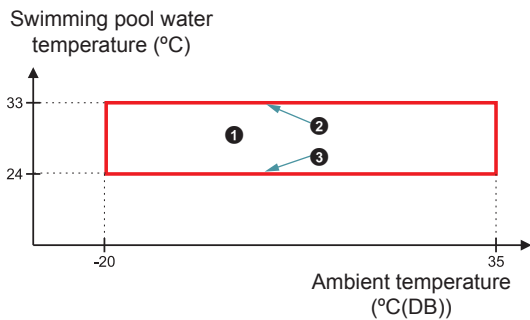

- ① Continuous working range.
- ② Maximum setting temperature.
- ③ Minimum setting temperature.

(4.0-10.0)HP

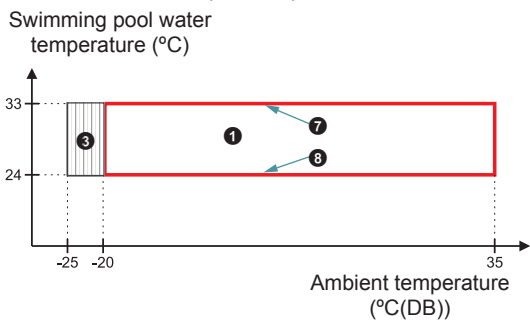

- ① Continuous working range.
- ③ Heat Pump operation possible.
- ⑦ Maximum setting temperature.
- ⑧ Minimum setting temperature.

5.2.4 Space cooling (Necessary cooling kit)

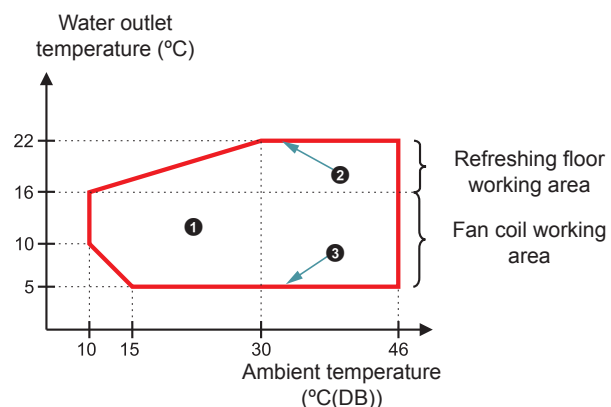

- ① Continuous working range.
- ② Maximum setting temperature.
- ③ Minimum setting temperature.

5.3 Hydraulic working range

5.3.1 Hydraulic data

◆ YUTAKI S

MODEL		2.0 HP	2.5 HP	3.0 HP	4.0 HP	5.0 HP	6.0 HP	8.0 HP	10.0 HP
Minimum water flow rate (*1)	m ³ /h	0.5	0.6	0.6	1.0	1.1	1.2	2.0	2.2
Maximum water flow rate (*1)	m ³ /h	1.9	2.0	2.1	2.9	3.0	3.0	4.5	4.6
Minimum installation water volume (*2)	l	28	28	28	38	46	55	76	79
Minimum allowable water pressure	MPa	0.1							
Maximum allowable water pressure	MPa	0.3							

◆ YUTAKI S COMBI

MODEL		2.0 HP	2.5 HP	3.0 HP	4.0 HP	5.0 HP	6.0 HP
Minimum water flow rate (*1)	m ³ /h	0.5	0.6	0.6	1.0	1.1	1.2
Maximum water flow rate (*1)	m ³ /h	1.8	1.9	1.9	2.7	2.8	2.8
Minimum installation water volume (*2)	l	28	28	28	38	46	55
Minimum allowable water pressure	MPa	0.1					
Maximum allowable water pressure	MPa	0.3					

NOTE

- (*1): Values calculated based on the following conditions:
Water inlet/outlet temperature: 30/35 °C
Outdoor ambient temperature: (DB/WB): 7/6 °C
- (*2): Values calculated with an ON/OFF temperature differential value of 4 °C.

5.3.2 Pump performance curves

NOTE

If a water flow rate is selected out of the working range of the unit, it can cause malfunction on the unit. Please, try to operate the pump within the minimum and maximum water flow of the indoor unit.

◆ YUTAKI S

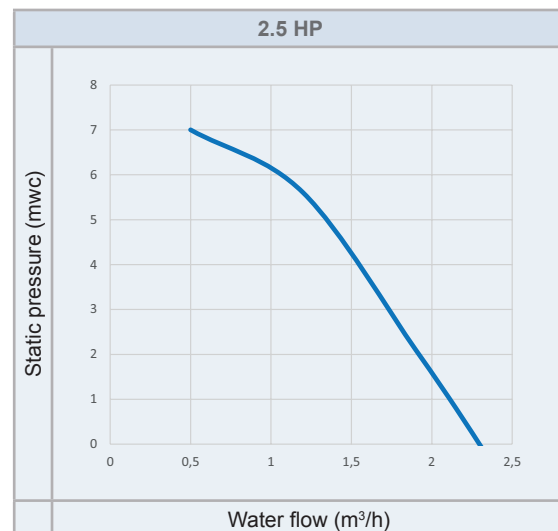
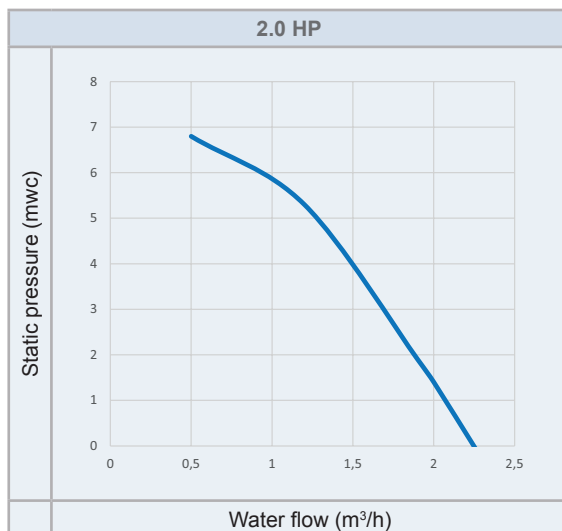

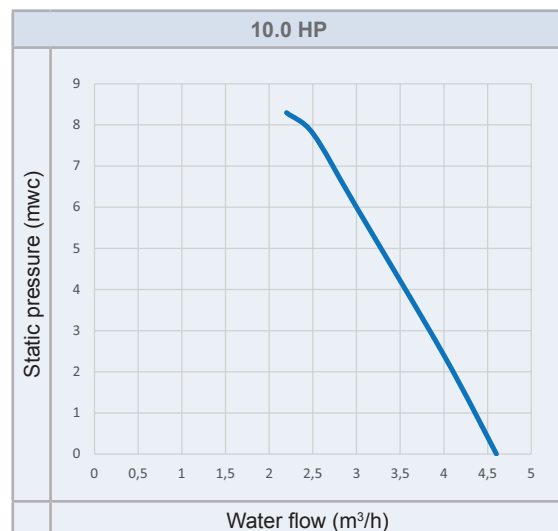
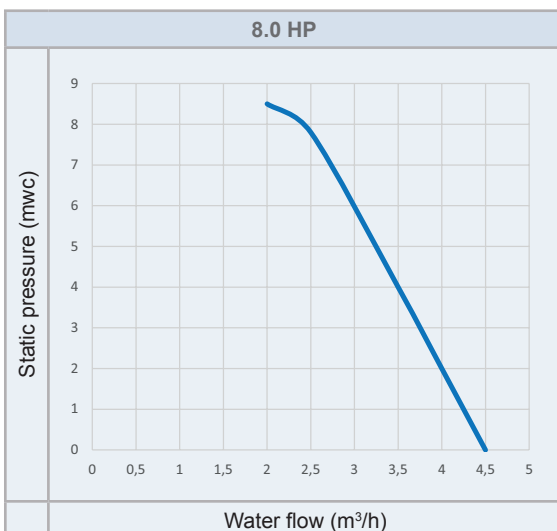
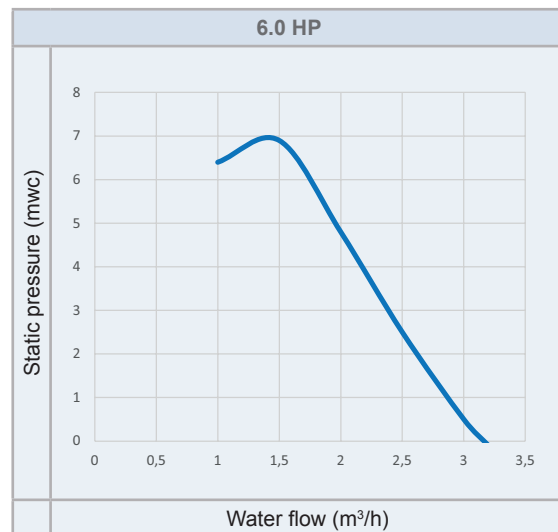
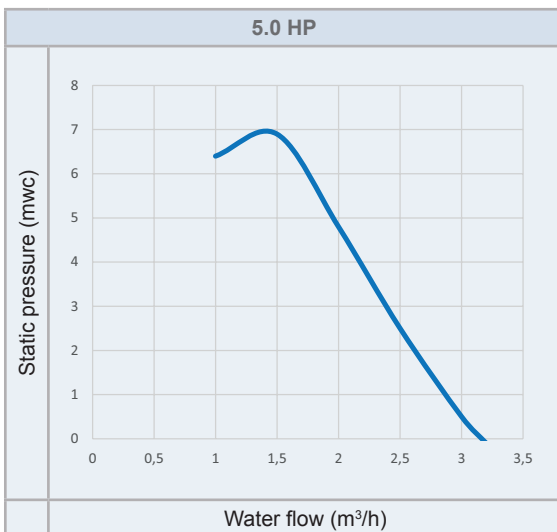
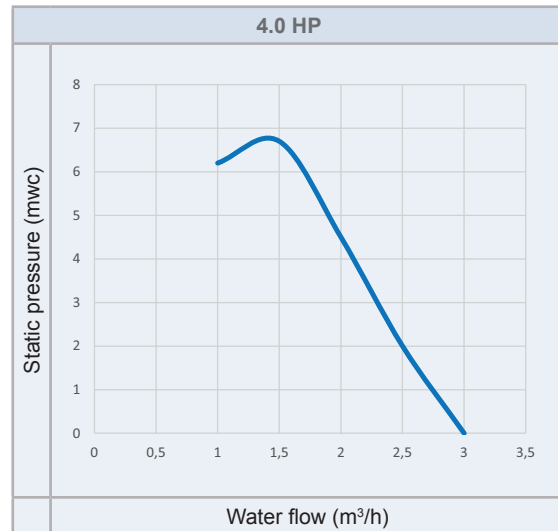
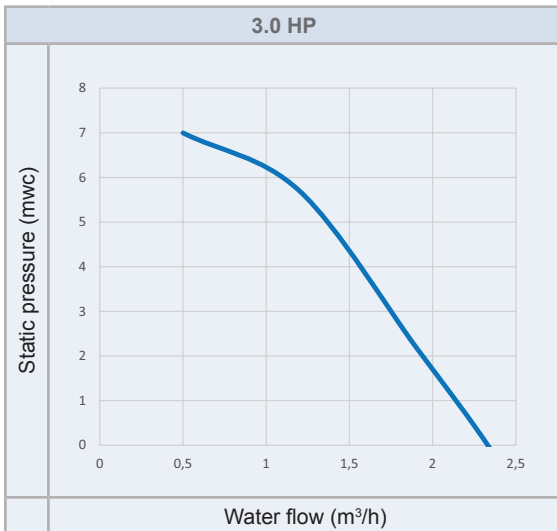

◆ YUTAKI S COMBI

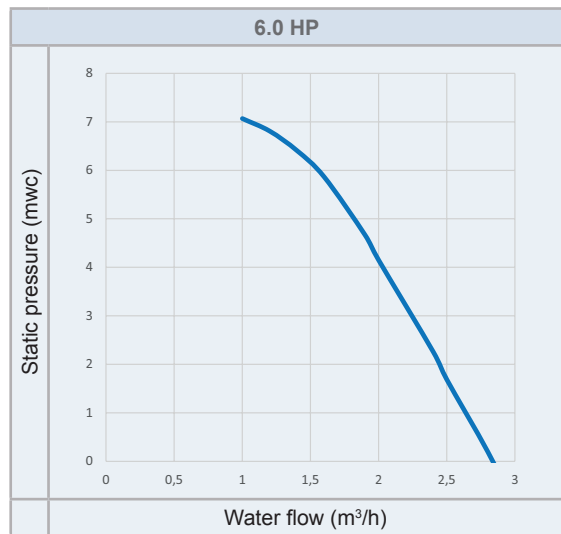
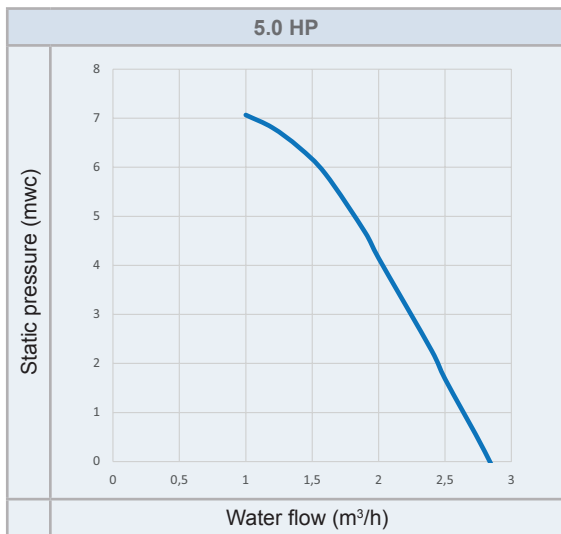
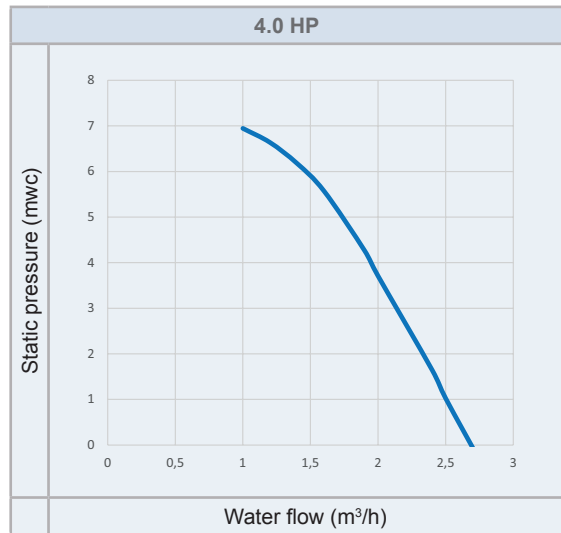
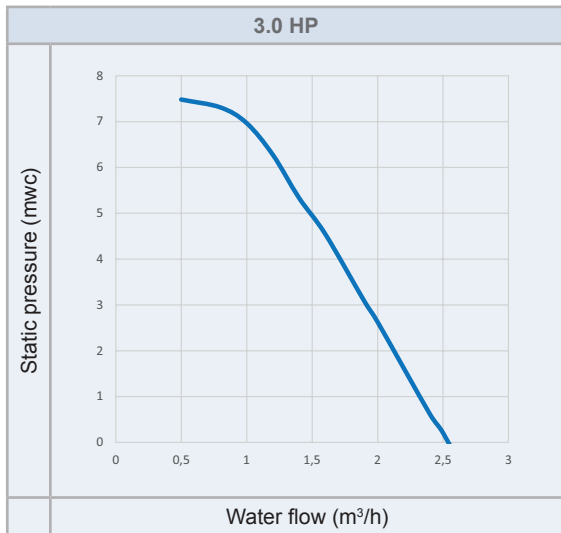
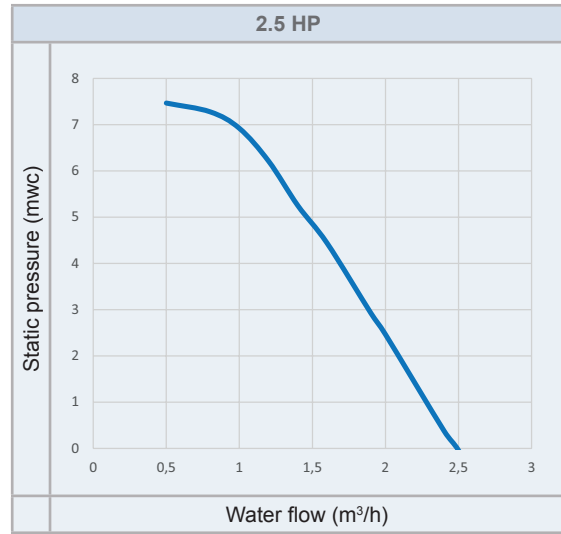
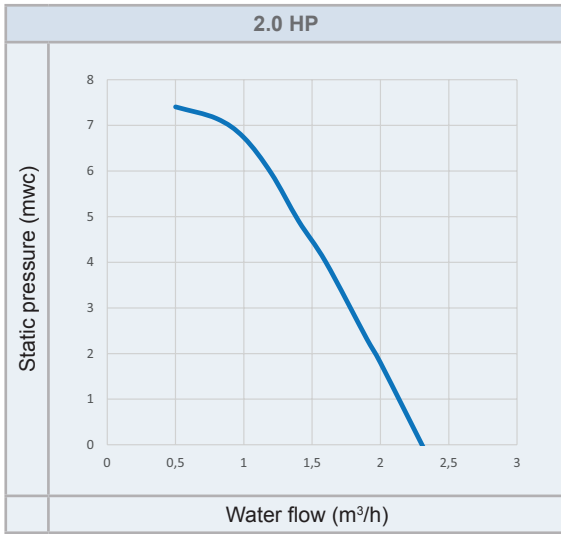

6 . General dimensions

Index

6.1	Name of parts and Dimensional data	86
6.1.1	Split system - Outdoor unit	86
6.1.2.2	YUTAKI S COMBI	91
6.2	Service space	92
6.2.1	Split system - Outdoor unit	92
6.2.2	Split system - Indoor unit	95
6.2.2.1	YUTAKI S	95
6.2.2.2	YUTAKI S COMBI	96

6.1 Name of parts and Dimensional data

6.1.1 Split system - Outdoor unit

◆ RAS-(2-3)WHVRP1

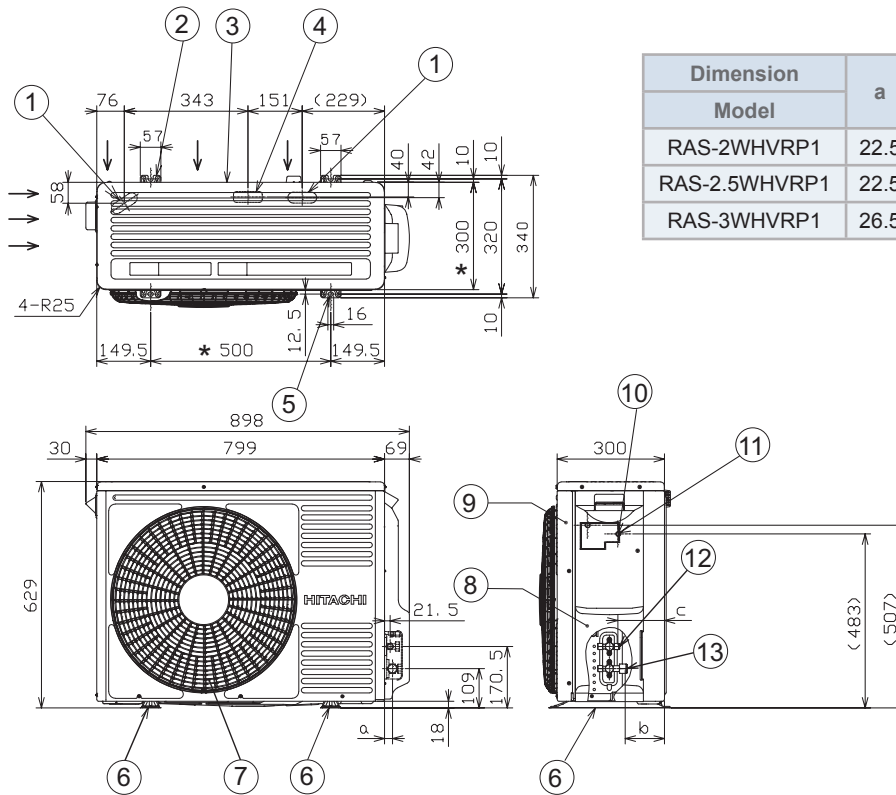

Dimension	a	b	c	d	e
Model					
RAS-2WHVRP1	22.5	109	129	12.7	6.35
RAS-2.5WHVRP1	22.5	109	129	12.7	6.35
RAS-3WHVRP1	26.5	103	127.5	15.88	9.52

Units: mm

i NOTE

The dimensions with the * mark indicate the pitch dimension of the holes for attachment of anchor bolts.

N°	Description	Remarks
1	Punched drain hole for bush	30x80 long hole
2	Attachment hole for M10 anchor bolt	2-U cut hole
3	Air suction inlet	—
4	Punched drain hole	For drain pipe
5	Attachment hole for M10 anchor bolt	2-Long hole
6	Foot part	
7	Air discharge outlet	—
8	Pipe cover	—
9	Service cover	—
10	Terminal board for power supply and transmission Terminal screw of power supply wire (M5) Terminal screw of transmission wire (M4)	—
11	Terminal screw of earth wire (M5)	—
12	Connection of refrigerant liquid pipe	With flare nut for Øe copper pipe
13	Connection of refrigerant gas pipe	With flare nut for Ød copper pipe

◆ RAS-(4-10)WH(V)NPE

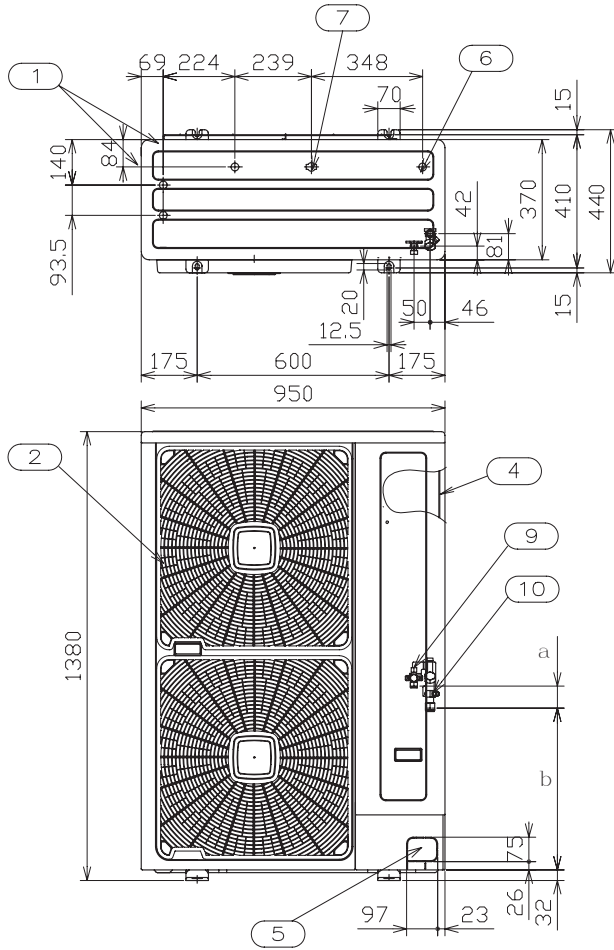

	4-6 HP	8 HP	10 HP
a	90	81	99
b	459	465	465

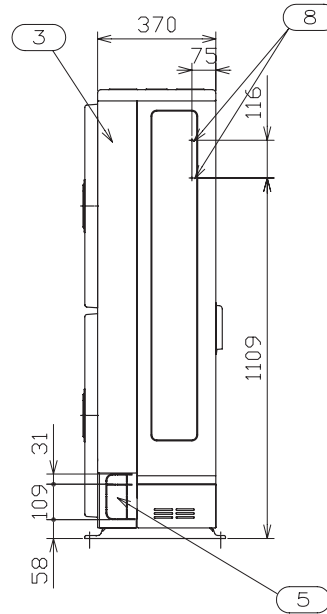

Units: mm

Number	Description	Remarks
1	Air inlet	—
2	Air outlet	—
3	Service cover	—
4	Electrical switch box	—
5	Holes for refrigerant piping and electrical wiring piping	—
6	Drain holes	3-Ø24
7	Drain holes	2-Ø26
8	Holes for fixing machine to wall	4-(M5)
9	Refrigerant liquid pipe	—
10	Refrigerant gas pipe	—

6.1.2 Split system - Indoor unit

6.1.2.1 YUTAKI S

◆ RWM-(2.0-3.0)R1E

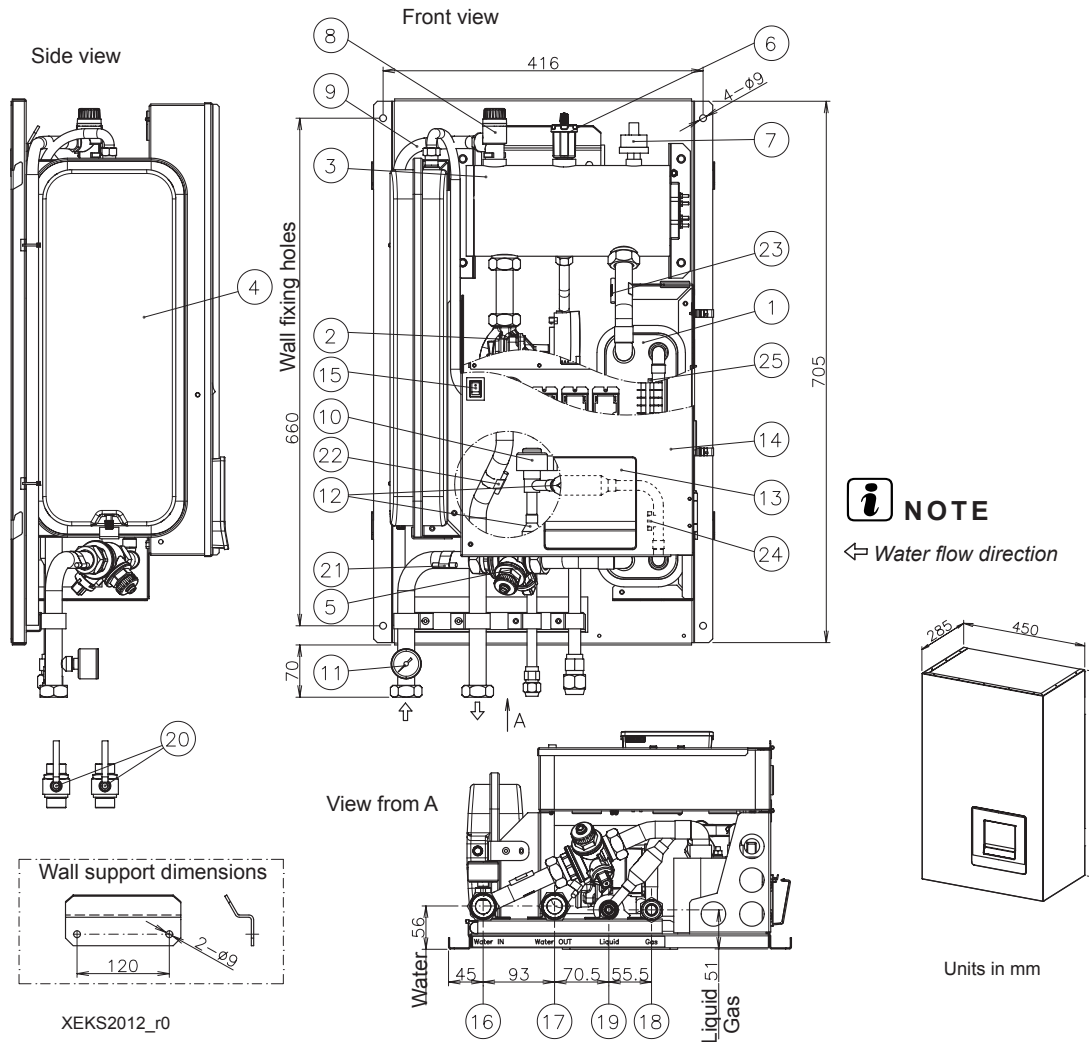

Number	Part name	Number	Part name
1	Plate heat exchanger	13	Unit controller
2	Water pump	14	Electrical box
3	Electric water heater	15	Switch for DHW emergency operation
4	Expansion vessel 6L	16	Water inlet pipe connection - G 1" Female
5	Water strainer	17	Water outlet pipe connection - G 1" Female
6	Air purger	18	Refrigerant gas pipe connection - \varnothing 15.88 (5/8")
7	Water pressure sensor	19	Refrigerant liquid pipe connection 2.0HP: \varnothing 6.35 (1/4") / (2.5-3.0)HP: \varnothing 9.52 (3/8")
8	Safety valve	20	Shut-down valve (Factory-supplied accessory)
9	Drain pipe for safety valve	21	Thermistor (Water inlet pipe)
10	Expansion valve	22	Thermistor (Water outlet pipe)
11	Manometer	23	Thermistor (Water outlet PHEX)
12	Refrigerant strainer (x2)	24	Thermistor (Liquid refrigerant pipe)
		25	Thermistor (Gas refrigerant pipe)

◆ RWM-(4.0-6.0)N1E

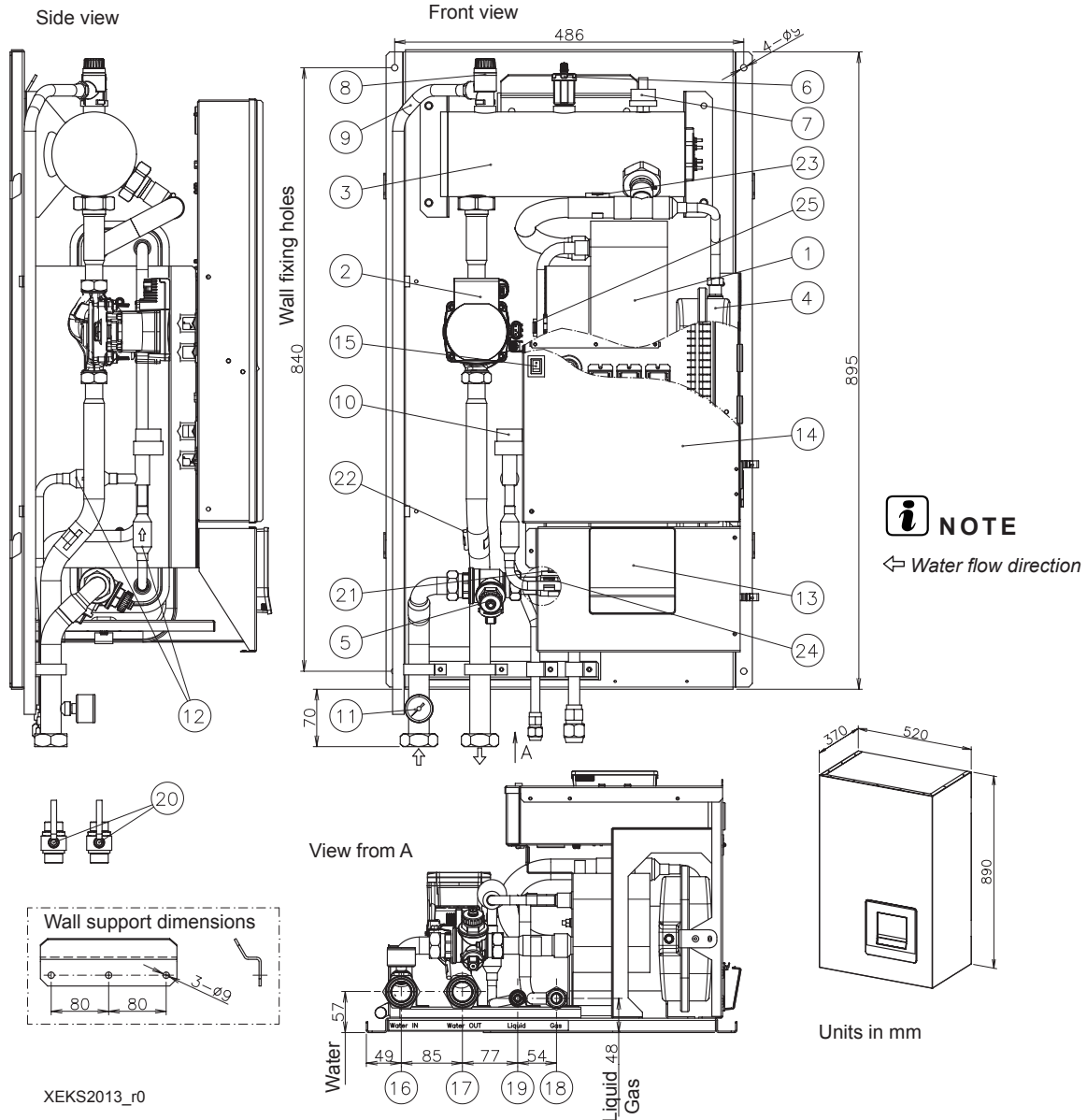

XEKS2013_r0

Number	Part name	Number	Part name
1	Plate heat exchanger	13	Unit controller
2	Water pump	14	Electrical box
3	Electric water heater	15	Switch for DHW emergency operation
4	Expansion vessel 6L	16	Water inlet pipe connection - G 1 1/4" female
5	Water strainer	17	Water outlet pipe connection - G 1 1/4" female
6	Air purger	18	Refrigerant gas pipe connection - Ø 15.88 (5/8")
7	Water pressure sensor	19	Refrigerant liquid pipe connection - Ø 9.52 (3/8")
8	Safety valve	20	Shut-down valve (Factory supplied accessory)
9	Drain pipe for safety valve	21	Thermistor (Water inlet pipe)
10	Expansion valve	22	Thermistor (Water outlet pipe)
11	Manometer	23	Thermistor (Water outlet PHEX)
12	Refrigerant strainer (x2)	24	Thermistor (Liquid refrigerant pipe)
		25	Thermistor (Gas refrigerant pipe)

◆ RWM-(8.0-10.0)N1E

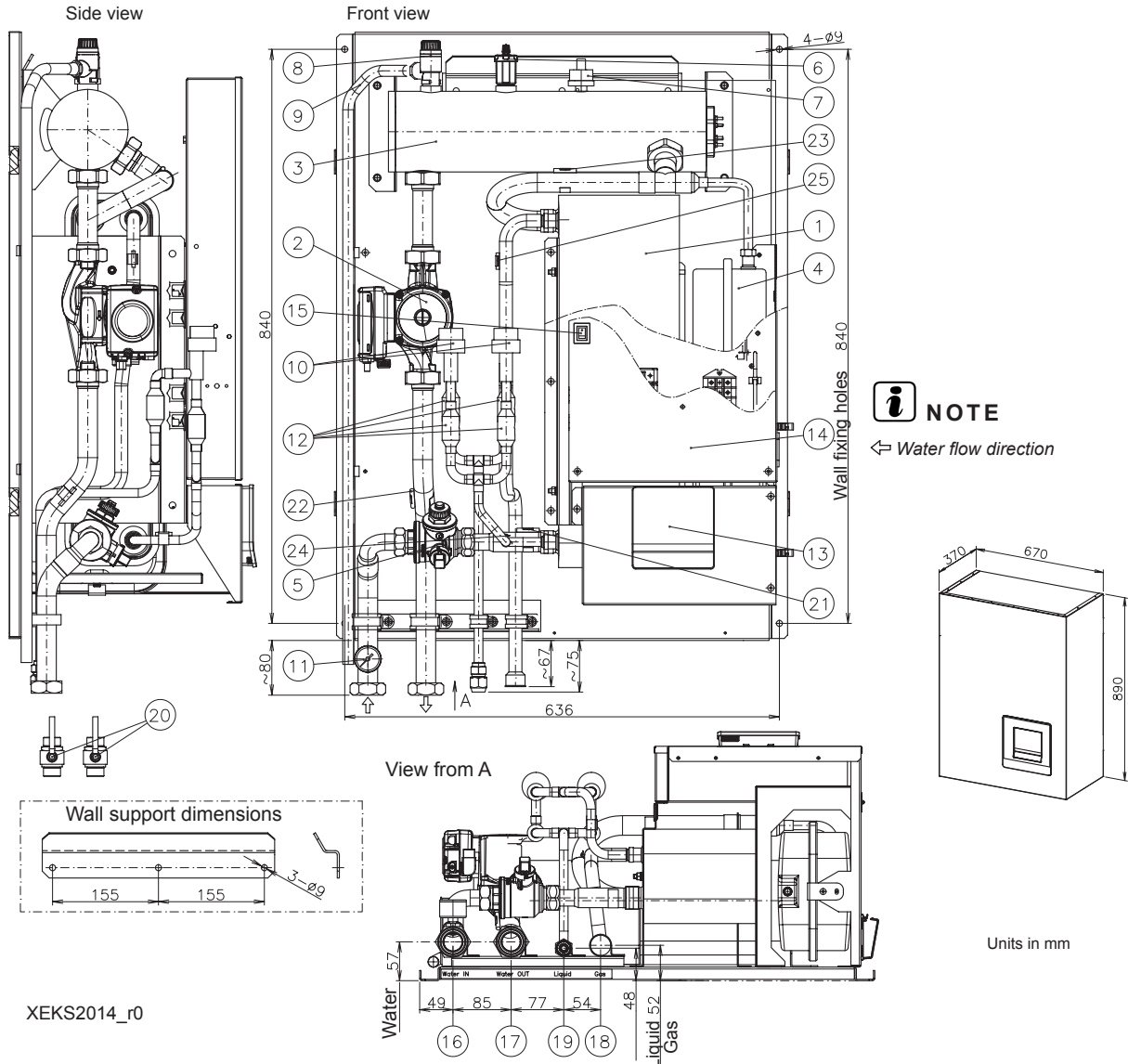

XEKS2014_r0

Number	Part name	Number	Part name
1	Plate heat exchanger	13	Unit controller
2	Water pump	14	Electrical box
3	Electric water heater	15	Switch for DHW emergency operation
4	Expansion vessel 10L	16	Water inlet pipe connection - G 1 1/4" Female
5	Water strainer	17	Water outlet pipe connection - G 1 1/4" Female
6	Air purger	18	Refrigerant gas pipe connection - Ø25.4 (1")
7	Water pressure sensor	19	Refrigerant liquid pipe connection 8HP: Ø9.52 (3/8") / 10HP: Ø12.7 (1/2")
8	Safety valve	20	Shut-down valve (factory-supplied accessory)
9	Drain pipe for safety valve	21	Thermistor (Water inlet pipe)
10	Expansion valve (x2)	22	Thermistor (Water outlet pipe)
11	Manometer	23	Thermistor (Water outlet PHEX)
12	Refrigerant strainer (x4)	24	Thermistor (Liquid refrigerant pipe)
		25	Thermistor (Gas refrigerant pipe)

6.1.2.2 YUTAKI S COMBI

◆ RWD-(2.0-6.0)(N/R)W1E-220S(-K)

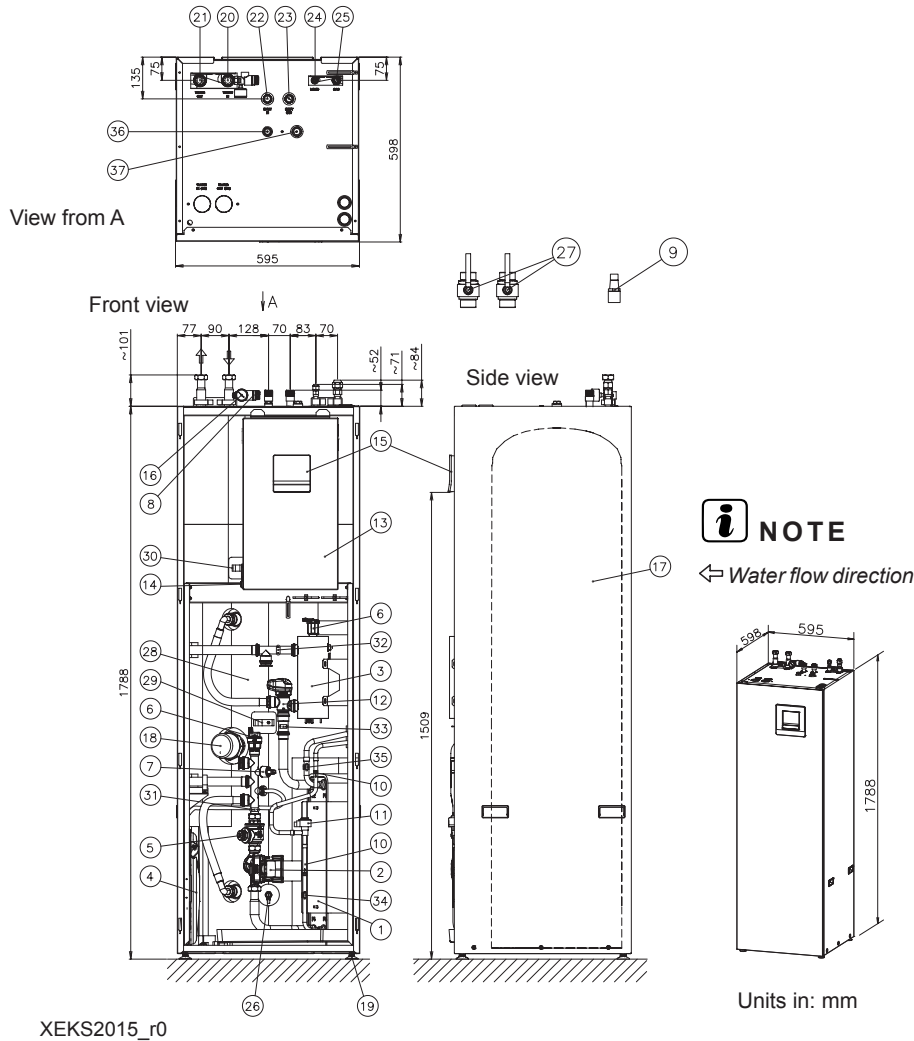

XEKS2015_r0

Number	Part name	Number	Part name
1	Plate heat exchanger	20	Water inlet pipe connection 2.0-6.0HP: G 1" female
2	Water pump	21	Water outlet pipe connection 2.0-6.0HP: G 1" female
3	Electric water heater	22	DHW inlet pipe connection - G 3/4" male
4	Expansion vessel 6L	23	DHW outlet pipe connection - G 3/4" male
5	Water strainer	24	Refrigerant liquid pipe connection 2.0HP: Ø 6.35 (1/4") / (2.5-6.0)HP: Ø9.52 (3/8")
6	Air purger (x2)	25	Refrigerant gas pipe connection - Ø15.88 (5/8")
7	Water pressure sensor	26	Drain port (For DHW) - G 3/8"
8	Safety valve	27	Shutdown valve (Factory supplied accessory)
9	Drain pipe for safety valve	28	Tank insulation
10	Refrigerant strainer (x2)	29	DHW thermistor 1
11	Expansion valve	30	DHW thermistor 2
12	3-way valve (for space heating and DHW)	31	Water inlet thermistor
13	Electrical box	32	Water outlet thermistor
14	Switch for DHW emergency operation	33	Water outlet PHEX thermistor
15	Unit controller	34	Refrigerant liquid pipe thermistor
16	Manometer	35	Refrigerant gas pipe thermistor
17	DHW tank (220L)	36	P&T Valve (Only UK Models)
18	DHW tank heater+thermostat	37	Anode connection (accessory)
19	Mounting foot (x4)		

6.2 Service space

6.2.1 Split system - Outdoor unit

◆ RAS-(2-3)WHVRP1

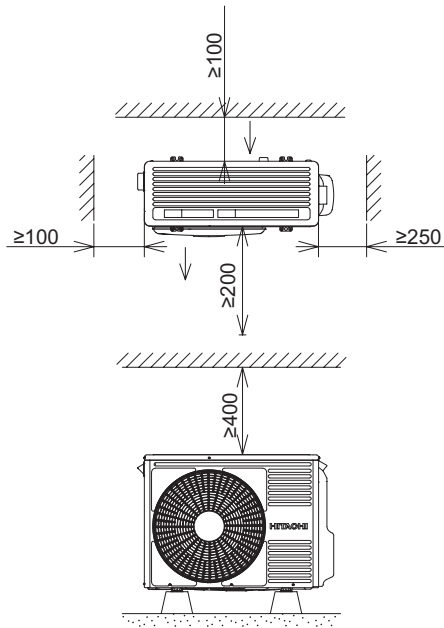

Units in mm.

a) In case of front side and either of the sides are open (single unit)		b) In case that surrounding wall exist (single unit)	
c) In case that upper side obstacles exist (single unit)			
		<p> $0 < L \leq 1/2 H \rightarrow A \geq 500$ $1/2 H < L \leq H \rightarrow A \geq 1000$ </p>	
d) In case that upper side obstacles exist (serial units)		e) In case of front side and either of the sides are open (serial units)	
<p> $0 < L \leq 1/2 H \rightarrow A \geq 500$ $1/2 H < L \leq H \rightarrow A \geq 1000$ </p>			

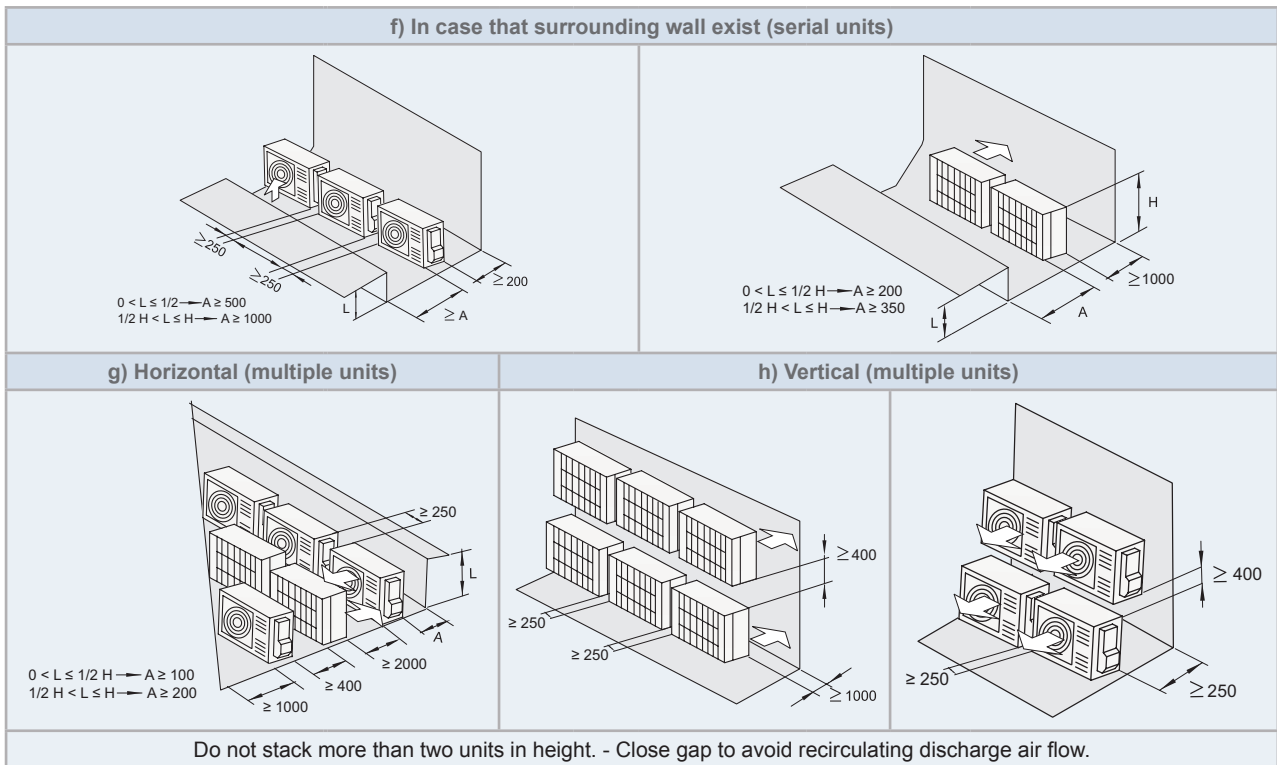

◆ **RAS-(4-10)WH(V)NPE**

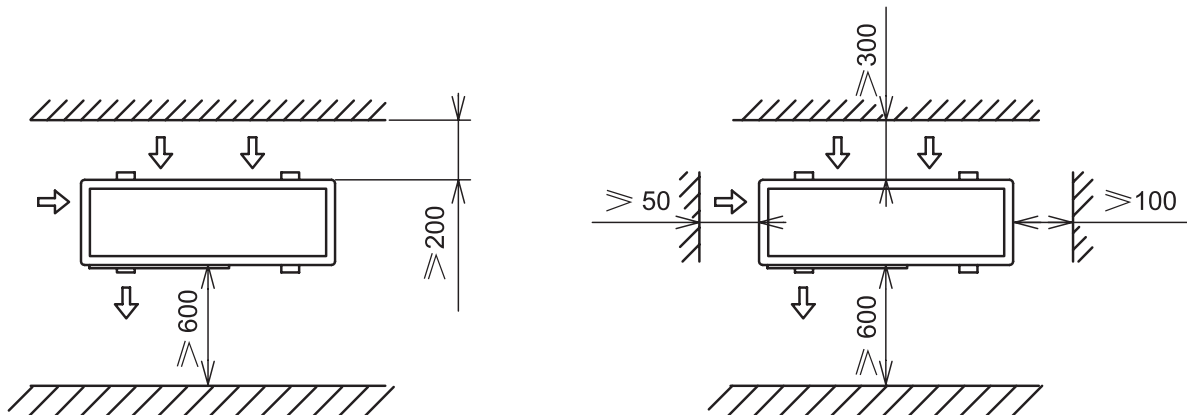

Units in mm.

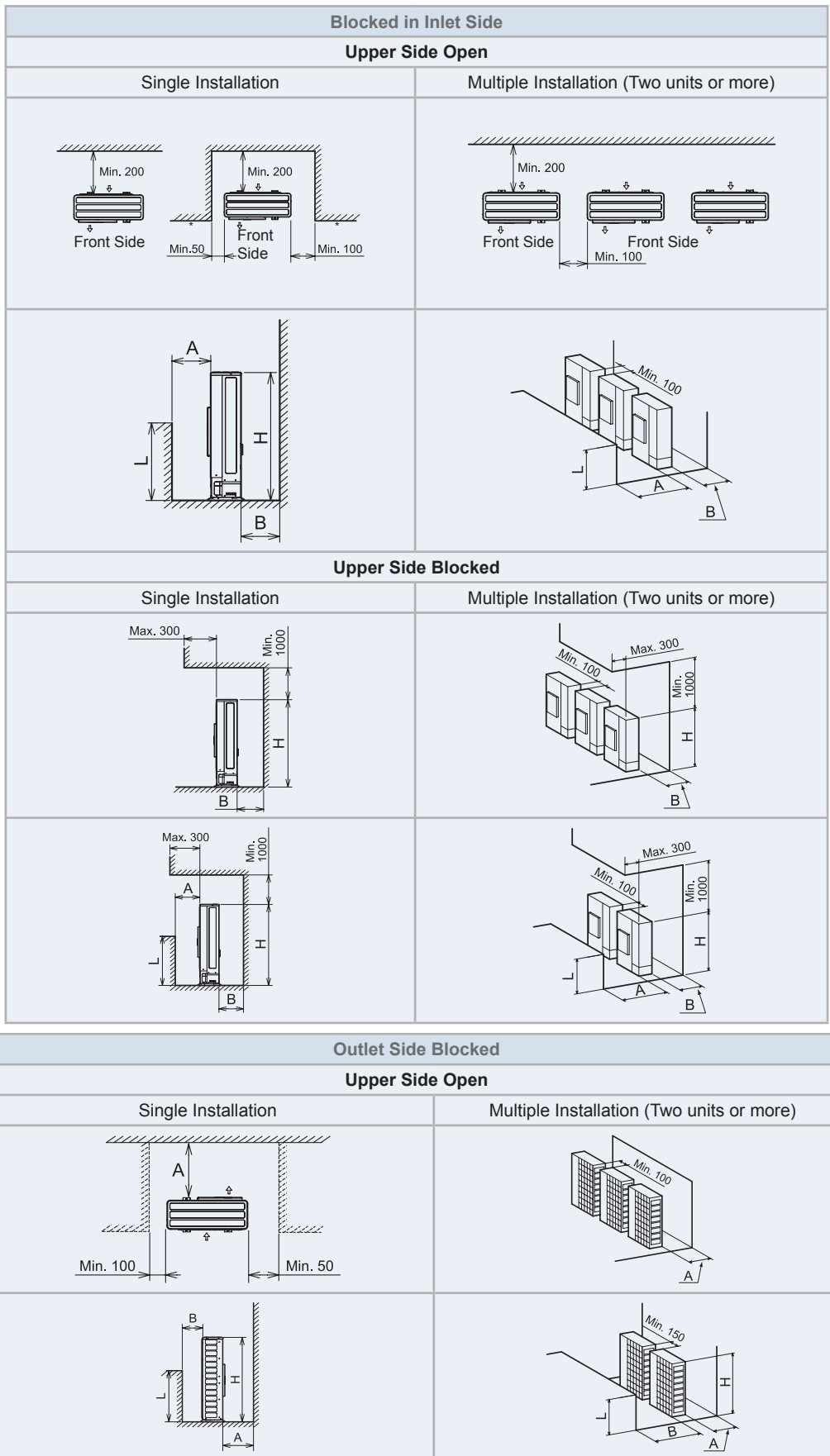

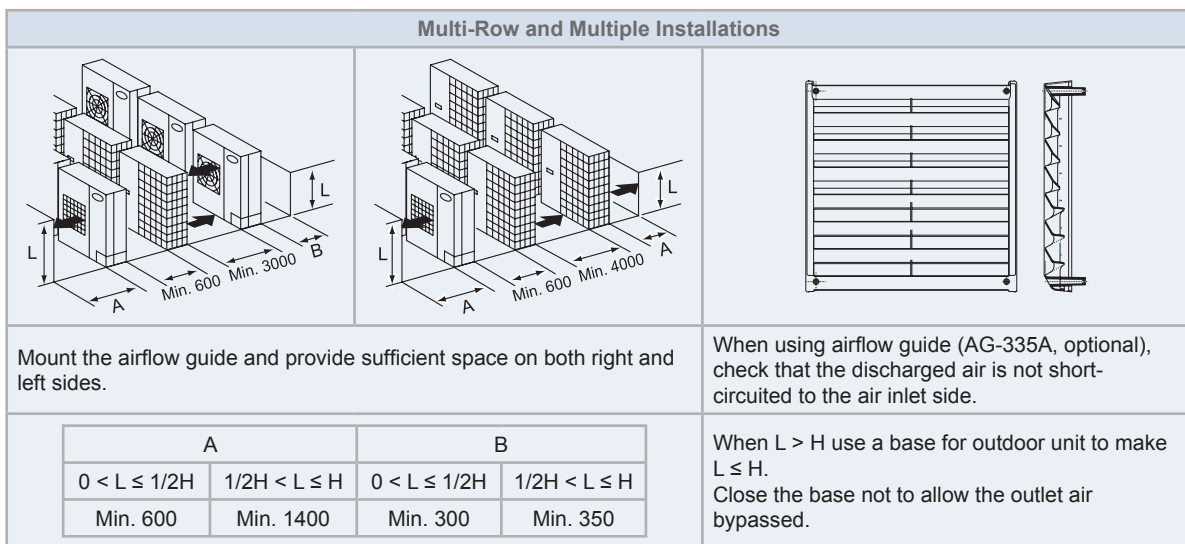
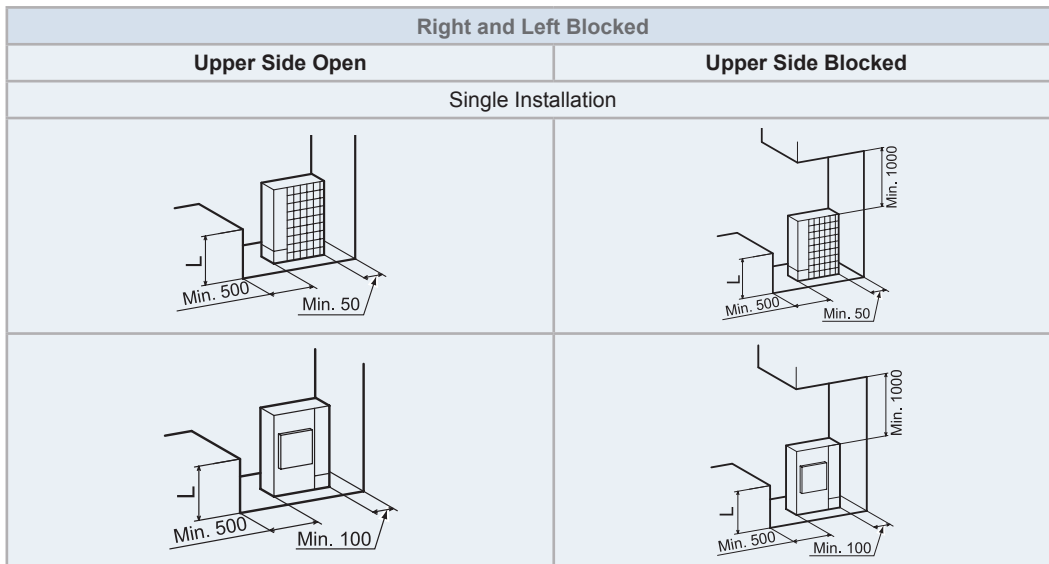

6.2.2 Split system - Indoor unit

6.2.2.1 YUTAKI S

◆ RWM-(2.0-10.0)(N/R)1E

H: 1200~1500 mm

Recommended unit height for proper access to the control unit panel (Unit controller).

h: 350 mm

Minimum unit height for installing the shut-off valves and the first bending pipe line.

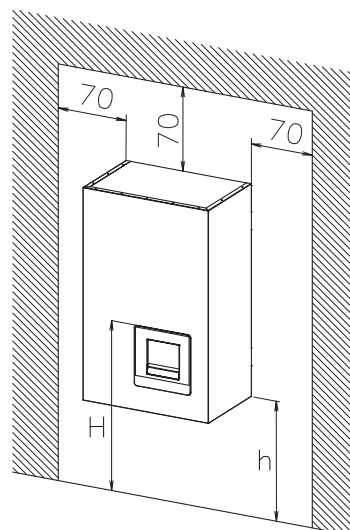

Units in mm.

6.2.2.2 YUTAKI S COMBI

◆ RWD-(2.0-6.0)(N/R)W1E-220S(-K)

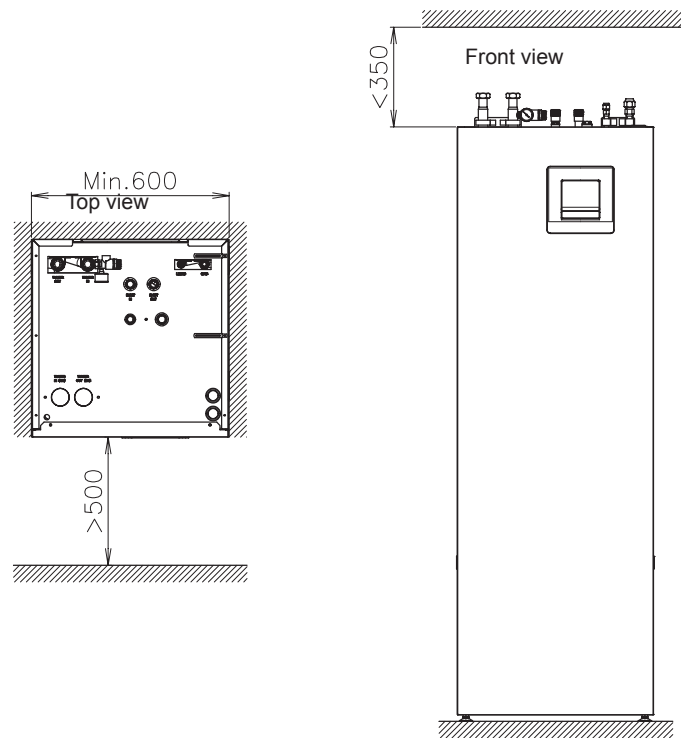

Units in mm.

7 . Refrigerant cycle and hydraulic circuit

Index

7.1	Refrigerant cycle and hydraulic circuit for Split system	98
7.1.1	Outdoor units	98
7.1.2	Indoor units.....	100



7.1 Refrigerant cycle and hydraulic circuit for Split system

7.1.1 Outdoor units

◆ RAS-(2-3)WHVRP1

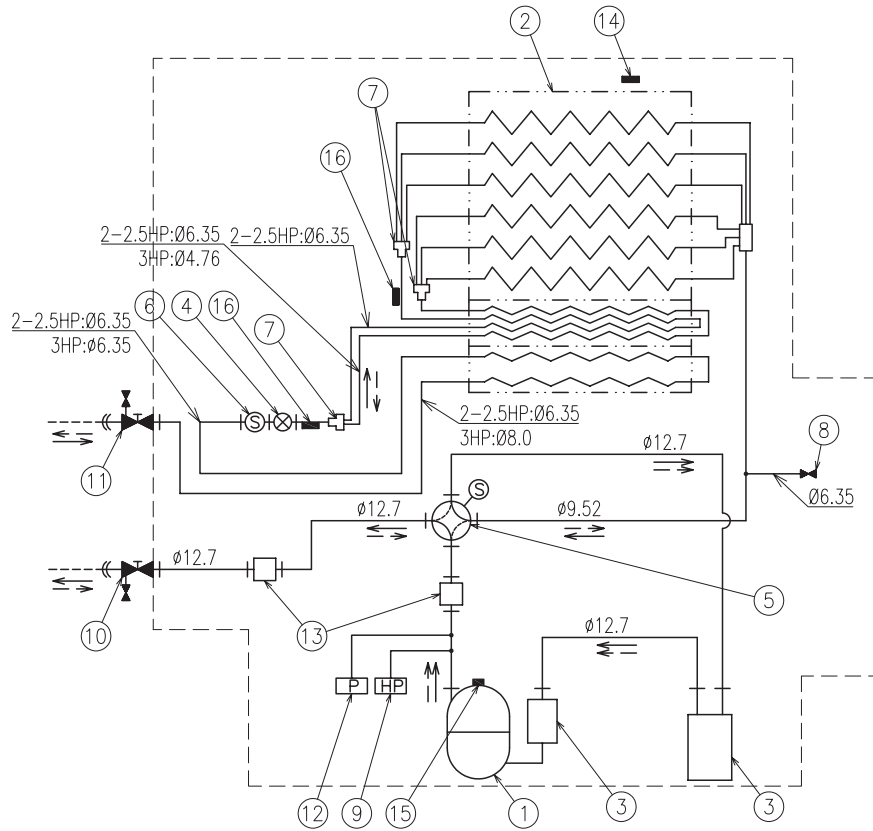

						Refrigerant
Heating refrigerant flow	Cooling refrigerant flow	Water flow (Heating/Cooling)	Field supplied piping line	Flare nut connection	Brazed connection	R32

N°	Part name
1	Compressor
2	Air side heat exchanger
3	Accumulator
4	OU electronic expansion valve
5	4-way valve
6	Refrigerant strainer
7	Distributor
8	Refrigerant check joint

N°	Part name
9	High pressure switch for protection
10	Stop valve for gas line
11	Stop valve for liquid line
12	Pressure switch for control
13	Silencer (only for 3 HP)
14	Ambient thermistor
15	Discharge gas thermistor
16	Pipe thermistor

◆ RAS-(4-10)WH(V)NPE

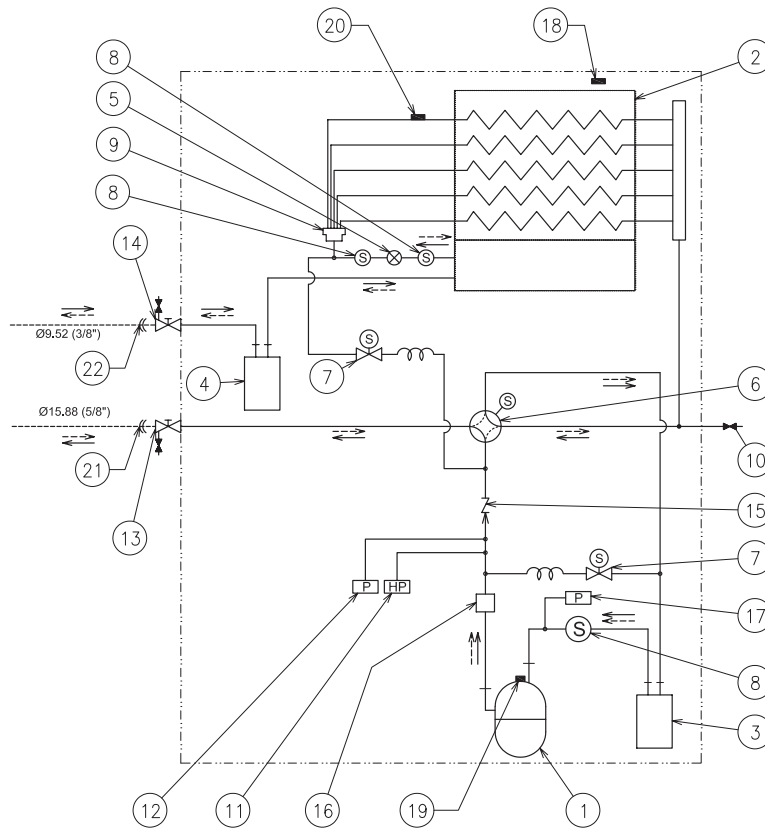

						Refrigerant
Heating refrigerant flow	Cooling refrigerant flow	Water flow (Heating/Cooling)	Field supplied piping line	Flare nut connection	Brazed connection	R410A

N1	Part name
1	Compressor
2	Air side heat exchanger
3	Accumulator
4	Receiver
5	OU electronic expansion valve
6	4-way valve
7	Solenoid gas for by-pass
8	OU refrigerant strainer
9	Distributor
10	Refrigerant check joint
11	High pressure switch for protection

N1	Part name
12	Sensor for refrigerant pressure
13	Stop valve for gas line
14	Stop valve for liquid line
15	Check valve
16	Silencer
17	Pressure switch for control
18	Ambient thermistor
19	Discharge gas thermistor
20	Pipe thermistor
21	OU refrigerant gas connection
22	OU refrigerant liquid connection



7.1.2 Indoor units

◆ YUTAKI S

RWM-(2.0-3.0)R1E

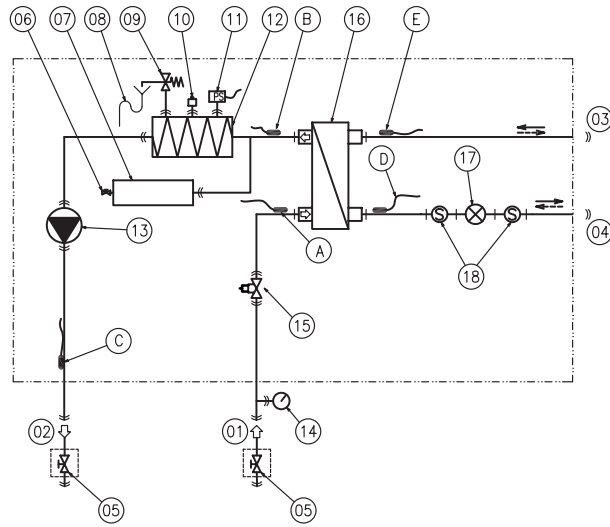

						Refrigerant
Heating refrigerant flow	Cooling refrigerant flow	Water flow (Heating/Cooling)	Field supplied piping line	Flare nut connection	Brazed connection	R32

N°	Part name
1	Water inlet connection (1-1/4")
2	Water outlet connection (1-1/4")
3	IU refrigerant gas connection
4	IU refrigerant liquid connection
5	Shut-off valve (1-1/4")
6	Drain for expansion vessel
7	Expansion vessel
8	Drain pipe (field supplied)
9	Safety valve
10	Air purger
11	Water pressure sensor
12	Water Electric Heater

N°	Part name
13	Water pump
14	Manometer
15	Filter Valve
16	Water side heat exchanger
17	Indoor Electronic Expansion valve (EVI)
18	Refrigerant strainer
A	Water inlet thermistor (THM _{wi})
B	Water outlet heat pump thermistor (THM _{whp})
C	Water outlet thermistor (THM _{wo})
D	Liquid pipe thermistor (Heating)
E	Gas pipe thermistor (Heating)

RWM-(4.0-10.0)N1E

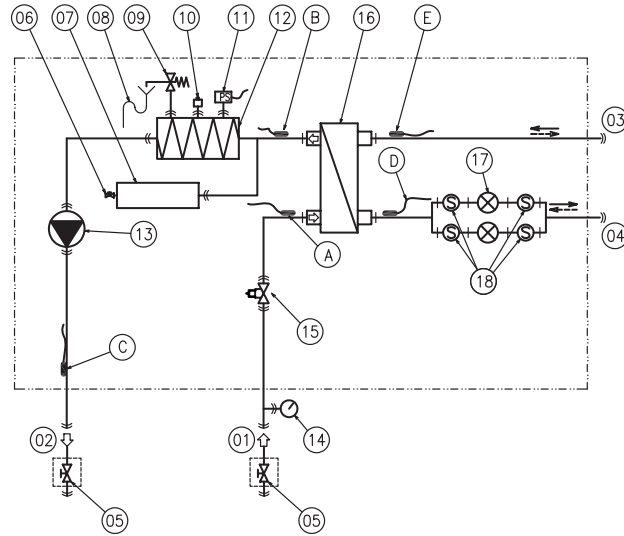

						Refrigerant
Heating refrigerant flow	Cooling refrigerant flow	Water flow (Heating/Cooling)	Field supplied piping line	Flare nut connection	Brazed connection	R410A

N°	Part name
1	Water inlet connection (1")
2	Water outlet connection (1")
3	IU refrigerant gas connection
4	IU refrigerant liquid connection
5	Shut-off valve (1")
6	Drain for Expansion vessel
7	Expansion vessel
8	Drain pipe (field supplied)
9	Safety valve
10	Air purger
11	Water pressure sensor
12	Water Electric Heater

N°	Part name
13	Water pump
14	Manometer
15	Filter Valve
16	Water side heat exchanger
17	Indoor Electronic Expansion valve (EVI)
18	Refrigerant strainer
A	Water inlet thermistor (THM _{wi})
B	Water outlet heat pump thermistor (THM _{whp})
C	Water outlet thermistor (THM _{wo})
D	Liquid pipe thermistor (Heating)
E	Gas pipe thermistor (Heating)



◆ YUTAKI S COMBI

RWD-(2.0-6.0)(N/R)W1E-220S(-K)

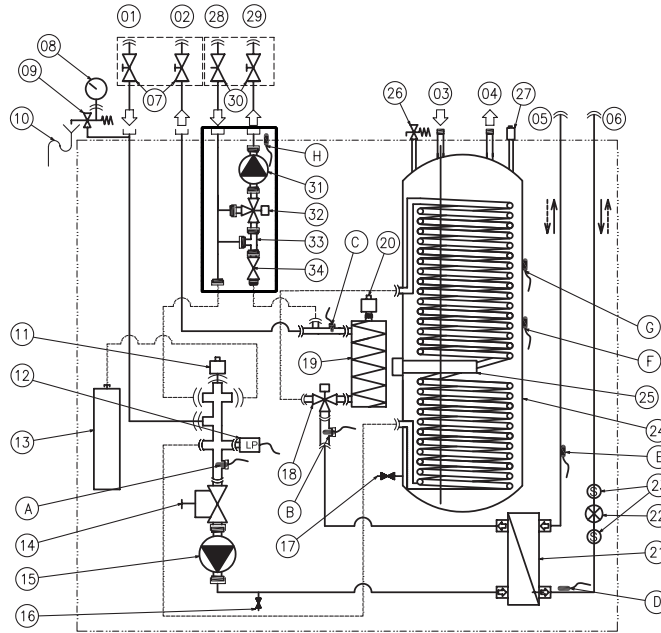

						Refrigerant
Heating refrigerant flow	Cooling refrigerant flow	Water flow (Heating/Cooling)	Field supplied piping line	Flare nut connection	Brazed connection	R32 R410A

N°	Part name
1	Water inlet connection (1")
2	Water outlet connection (1")
3	Water inlet (DHW)
4	Water outlet (DHW)
5	IU refrigerant gas connection
6	IU refrigerant liquid connection
7	Shut-off valve (1")
8	Manometer
9	Safety valve
10	Drain pipe (field supplied)
11	Air purger
12	Water pressure sensor
13	Expansion vessel
14	Filter Valve
15	Water pump
16	Drain port (for IU water)

N°	Part name
17	Drain port (for DHW)
18	3-way valve
19	Water Electric Heater
20	Air purger
21	Water side heat exchanger
22	Indoor Electronic Expansion valve (EVI)
23	Refrigerant strainer
24	Domestic hot water tank (DHWT)
25	DHWT electric heater
26	P & T relief valve (For UK market)
27	Active Anode (Accessory)
28	2nd Zone Water inlet connection (quick connection)
29	2nd Zone Water outlet connection (quick connection)

N°	Part name
30	Shut-off valve (1") (field accessory)
31	Water pump 2 (accessory)
32	Mixing Valve (accessory)
33	T-branch (accessory)
34	Detentor (accessory)
A	Water inlet thermistor (THM _{wi})
B	Water outlet heat pump thermistor (THM _{whp})
C	Water outlet thermistor (THM _{wg})
D	Liquid pipe thermistor (Heating)
E	Gas pipe thermistor (Heating)
F	DHW thermistor 1 (Bottom)
G	DHW thermistor 2 (Top)
H	Water outlet 2nd Zone thermistor (THM _{wo2}) (accessory)

8 . Refrigerant and water piping

Index

8.1	General notes before performing piping work	104
8.1.1	Piping work	104
8.1.2	Suspension of refrigerant and water pipes	104
8.2	R32 refrigerant circuit	105
8.2.1	General notes R32 refrigerant	105
8.2.2	Refrigerant piping	105
8.2.3	Refrigerant charge	107
8.2.3.1	Refrigerant charge amount	107
8.2.3.2	Refrigerant charge before shipment (W_0 (kg))	107
8.3	R410A refrigerant circuit	107
8.3.1	Refrigerant charge	107
8.3.2	Refrigerant piping	107
8.3.3	Refrigerant charge	108
8.3.3.1	Refrigerant charge amount	108
8.3.3.2	Refrigerant charge before shipment (W_0 (kg))	108
8.3.4	Precautions in the event of gas refrigerant leaks	108
8.4	Space heating and DHW	110
8.4.1	Additional hydraulic necessary elements for space heating	110
8.4.2	Additional hydraulic necessary elements for DHW	111
8.4.3	Additional hydraulic optional elements (For DHW)	113
8.4.4	Additional hydraulic necessary elements for DHW (only for UK market)	113
8.4.5	Requirements and recommendations for the hydraulic circuit	114
8.4.6	Water piping	115
8.4.7	Water quality	116

8.1 General notes before performing piping work

8.1.1 Piping work

- Prepare locally-supplied copper pipes.
- Select the piping size with the correct thickness and correct material able to withstand sufficient pressure.
- Select clean copper pipes. Make sure that there is no dust or moisture inside the pipes. Blow the inside of the pipes with oxygen free nitrogen to remove any dust and foreign materials before connecting them.

i NOTE

A system with no moisture or oil contamination will give maximum performance and lifecycle compared to that of a poorly prepared system. Take particular care to ensure that all copper piping is clean and dry internally.

- Cap the end of the pipe when pipe is to be inserted through a wall hole.
- Do not put pipes on the ground directly without a cap or vinyl tape at the end of the pipe.

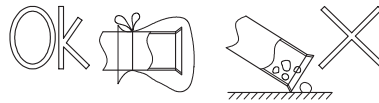

- If piping installation is not completed until next day or over a longer period of time, braze off the ends of the piping and charge with oxygen free nitrogen through a Schrader valve type access fitting to prevent moisture and particle contamination.
- It is advisable to insulate the water pipes, joints and connections in order to avoid heat loss and dew condensation on the surface of the pipes or accidental injuries due to excessive heat on piping surfaces.
- Do not use insulation material that contains NH_3 , as it can damage copper pipe material and become a source of future leakage.
- It is recommended to use flexible joints for the water piping inlet and outlet in order to avoid vibration transmission.
- Refrigerant circuit and Water circuit must be performed and inspected by a licensed technician and must comply with all relevant European and national regulations.
- Proper water pipe inspection should be performed after piping work to assure there is no water leakage in the space heating or DHW circuits.

8.1.2 Suspension of refrigerant and water pipes

- Suspend the refrigerant and water piping at certain points and prevent the refrigerant and water piping from being in direct contact with the building: walls, ceilings, etc.. If there is direct contact between pipes, abnormal sound may occur due to the vibration of the piping. Pay special attention in cases of short piping lengths.

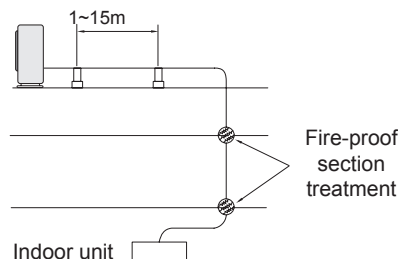

- Do not fix the refrigerant and water pipes directly with the metal fittings (refrigerant piping may expand and contract). Some examples for suspension method are shown below.

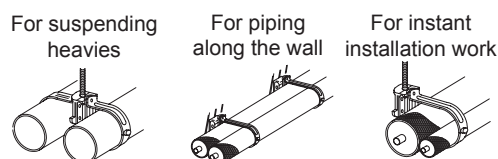

8.2 R32 refrigerant circuit

8.2.1 General notes R32 refrigerant

This appliance is filled with R32, an odourless flammable refrigerant gas with low burning velocity (A2L class pursuant to ISO 817). If the refrigerant is leaked, there is a possibility of ignition if it enters in contact with an external ignition source.

Make sure that unit installation and refrigerant piping installation comply with applicable legislation in each country. Also, in Europe, EN378 must be complied, as it is the applicable standard.

8.2.2 Refrigerant piping

◆ Refrigerant piping length between indoor unit and outdoor unit

The unit installation and refrigerant piping should comply with the relevant local and national regulations for the designed refrigerant.

Due to R32 refrigerant and depending on final refrigerant charge amount, a minimum floor area for installation must be considered.

- If total refrigerant charge amount <1.84kg, there are no additional minimum floor area requirements.
- If total refrigerant charge amount ≥1.84kg, there are additional minimum floor area requirements to be checked.

New YUTAKI R32 range (2-3)HP due to low refrigerant charge amount and due to low additional charge needed, unit installation can achieve up to 30m (*27m for 3HP) without any minimum floor area requirement.

		2HP	2.5HP	3HP
Factory Charge	kg	1.20	1.30	1.30
Charge-less piping length	m	10	10	10
Additional Charge needed	g/m	15	15	30
Maximum piping	m	30	30	27
Maximum total refrigerant charge	kg	1.50	1.60	1.81
Minimum room area requirement (Amin)	m ²	No requirement is needed		
Minimum piping length between outdoor unit and indoor unit (Lmin)	m	3		
Maximum height difference between indoor and outdoor unit (H)				
	Outdoor unit higher than indoor unit	m	30 (2/2.5HP) 27 (3HP)	
	Indoor unit higher than outdoor unit	m	20	

In case of increasing more than 30m (27m for 3HP) a minimum floor area requirement must be considered.

		2HP	2.5HP	3HP (*)
Factory Charge	kg	1.20	1.30	1.30
Charge-less piping length	m	10	10	10
Additional Charge needed	g/m	15	15	30
Maximum piping	m	50	50	40
Maximum total refrigerant charge	kg	1.80	1.90	2.20
Minimum room area requirement (Amin)	m ²	No requirement is needed	Minimum area is required	
Minimum piping length between outdoor unit and indoor unit (Lmin)	m	3		
Maximum height difference between indoor and outdoor unit (H)				
	Outdoor unit higher than indoor unit	m	30	
	Indoor unit higher than outdoor unit	m	20	

NOTE

(*) In case of 3HP with piping length >27m, refrigerant piping diameter and additional charge quantity must be considered.

◆ Minimum area requirements

In case of total refrigerant amount ≥ 1.84 kg, the unit should be installed, operated and stored in a room with a floor area larger than the minimum criteria. Use following graphic and table to determine these minimum criteria:

Refrigerant Amount (kg)	Minimum Area (m ²) (H:2.2m)
1.84	28.81
1.9	30.72
2.0	34.09
2.1	37.53
2.2	41.19
2.3	45.02
2.4	49.02
2.5	53.19
2.6	57.53
2.7	62.04
2.8	66.72
2.9	71.58

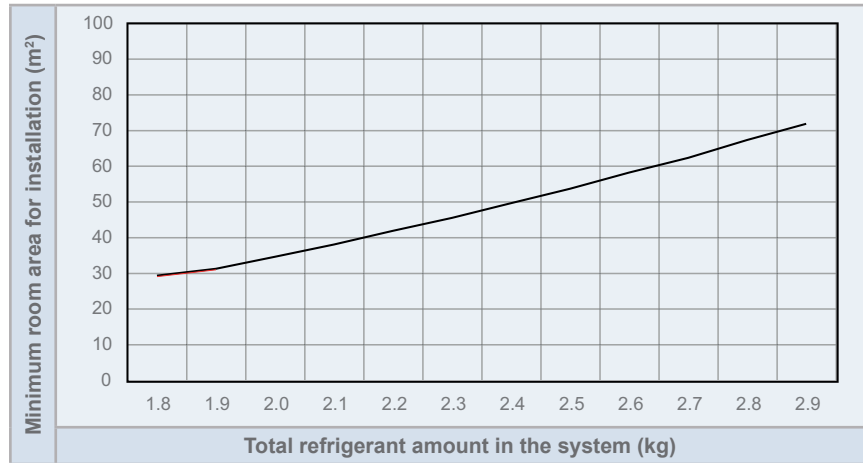

NOTE

In case of not achieving the minimum floor area, contact with your dealer.

◆ Refrigerant piping size

Piping connection size of outdoor unit & indoor unit

Model	Piping length	Outdoor unit		Refrigerant pipe (Between Outdoor unit and Indoor unit)		Indoor Unit	
		Pipe Connection size				Pipe Connection size	
		Gas pipe	Liquid pipe	Gas pipe	Liquid pipe	Gas pipe	Liquid pipe
2HP	3~50m	Ø 12.7 (1/2")	Ø 6.35 (1/4")	Ø 12.7	Ø 6.35	Ø 15.88 (5/8") (*)	Ø 6.35 (1/4")
2.5HP	3~50m						Ø 9.52 (3/8") (*)
3HP	3~27m	Ø 15.88 (5/8") (*)	Ø 9.52 (3/8") (*)	Ø 15.88	Ø 6.35	Ø 15.88 (5/8")	Ø 9.52 (3/8") (*)
	27~40m	Ø 15.88 (5/8")	Ø 9.52 (3/8")	Ø 15.88	Ø 9.52	Ø 15.88 (5/8")	Ø 9.52 (3/8") (*)



NOTE

(*): The refrigerant gas and liquid piping size for 2/2.5/3HP are different between outdoor and indoor unit, so refrigerant pipe adapters are required. These pipe adapters are factory supplied with the outdoor unit:

Model	Pipe adapter	
	Gas pipe	Liquid pipe
2 HP	Ø15.88→Ø12.7	-
2.5 HP	Ø15.88→Ø12.7	Ø9.52→Ø6.35
3 HP	-	Ø9.52→Ø6.35 (x2)

8.2.3 Refrigerant charge

8.2.3.1 Refrigerant charge amount

The R32 refrigerant is factory charged in the outdoor unit with a refrigerant charge amount for 10 m of piping length between outdoor and indoor unit.

8.2.3.2 Refrigerant charge before shipment (W_0 (kg))

Outdoor unit model	W_0 (kg)
RAS-2WHVRP1	1.2
RAS-2.5WHVRP1	1.3
RAS-3WHVRP1	1.3

8.3 R410A refrigerant circuit

8.3.1 Refrigerant charge

The R410A refrigerant is factory charged in the outdoor unit.

i NOTE

Refer to the outdoor unit Installation and operation manual to charge the R410A refrigerant.

8.3.2 Refrigerant piping

◆ Refrigerant piping length between indoor unit and outdoor unit

The refrigerant piping length between indoor unit and outdoor unit should be designed using the following chart.

Keep the design point within the area of the chart, which is showing the applicable height difference according to piping length.

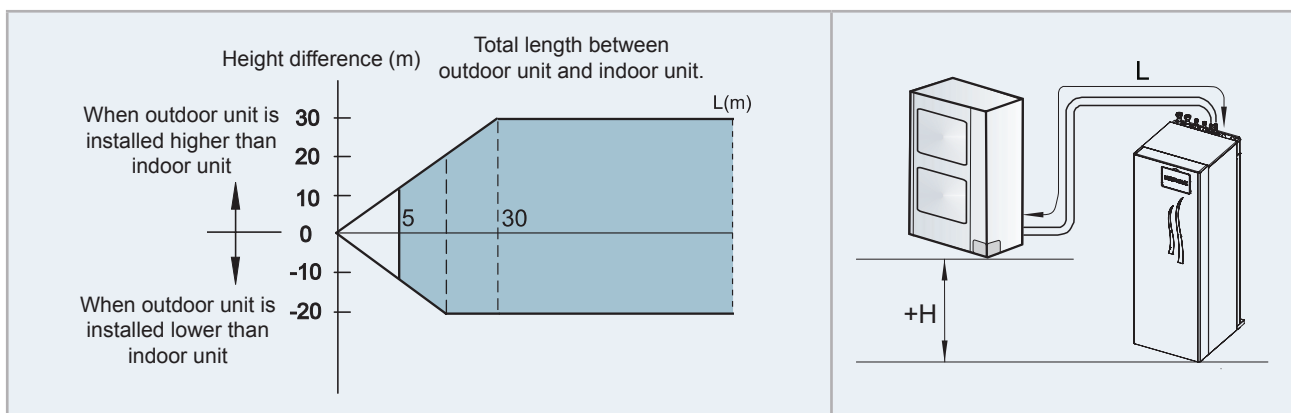

Outdoor Unit (HP)		4	5	6	8	10
Maximum piping length between outdoor unit and indoor unit (L_{max})	Actual piping length (L)	75 m			70 m	
	Equivalent piping length	95 m			90 m	
Minimum piping length between outdoor unit and indoor unit (L_{min})	Actual piping length (L)	5 m				
Maximum height difference between indoor and outdoor unit (H)	Outdoor unit higher than indoor unit	30 m				
	Indoor unit higher than outdoor unit	20 m				

◆ Refrigerant piping size

Piping connection size of outdoor unit & indoor unit

Outdoor unit			Indoor unit		
Model	Pipe size		Model	Pipe size	
	Gas pipe	Liquid pipe		Gas pipe	Liquid pipe
(4-6) HP	Ø 15.88 (5/8")	Ø 9.52 (3/8")	(4.0-6.0) HP	Ø 15.88 (5/8")	Ø 9.52 (3/8")
8 HP	Ø 25.4 (1")	Ø 9.52 (3/8")	8 HP	Ø 25.4 (1")	Ø 9.52 (3/8")
10 HP		Ø 12.7 (1/2")	10 HP		Ø 12.7 (1/2")



NOTE

For 8 and 10 HP, the gas pipe accessory with a flare nut (factory-supplied silencer) shall be brazed to the field supplied gas line, and connected to the gas valve.

8.3.3 Refrigerant charge

8.3.3.1 Refrigerant charge amount

The R410A refrigerant is factory charged in the outdoor unit with a refrigerant charge amount for 15 m of piping length between outdoor and indoor unit.

8.3.3.2 Refrigerant charge before shipment (W_0 (kg))

Outdoor unit model	W_0 (kg)
RAS-4WH(V)NPE	3.3
RAS-(5/6)WH(V)NPE	3.4
RAS-8WHNPE	5.0
RAS-10WHNPE	5.3

8.3.4 Precautions in the event of gas refrigerant leaks

The installers and those responsible for drafting the specifications are obliged to comply with local safety codes and regulations in the case of refrigerant leakage.



CAUTION

- Check for refrigerant leakage in detail. If a large refrigerant leakage occurred, it would cause difficulty with breathing or harmful gases would occur if a fire were in the room.
- If the flare nut is tightened too hard, it may crack over time and cause refrigerant leakage.

◆ Maximum permitted concentration of HFCs

The refrigerant R410A (charged in the outdoor unit) is incombustible and non-toxic gases. However, if leakage occurs and gas fills a room, it may cause suffocation.

The maximum permissible concentration of HFC gas according to EN378-1 is:

Refrigerant	Maximum permissible concentration (kg/m ³)
R410A	0.44

The minimum volume of a closed room where the system is installed to avoid suffocation in case of leakage is:

System combination		Minimum volume (m ³)
YUTAKI (S / S COMBI)	4 HP	7.5
	5/6 HP	7.8
YUTAKI S	8 HP	11.4
	10 HP	12.1

The formula used for the calculation of the maximum allowed refrigerant concentration in case of refrigerant leakage is the following:

R	R: Total quantity of refrigerant charged (kg)
$\frac{R}{V} = C$	V: Room volume (m ³)
V	C: Refrigerant concentration

If the room volume is below the minimum value, some effective measure must be taken account after installing to prevent suffocation in case of leakage.

◆ Countermeasure in the event of possible refrigerant leakage

The room must have the following features to prevent suffocation in case a refrigerant leakage occurs:

- 1 Provide a shutterless opening which will allow fresh air to circulate into the room.
- 2 Provide a doorless opening of 0.15% or more size to the floor area.
- 3 There must be a ventilator fan connected to a gas leak detector, with a ventilator capacity of 0.4 m³/min or higher per Japanese refrigeration ton (= compressor displacement volume / (5.7 m³/h (R410A)) of the air conditioning system using the refrigerant.

Model	Tonnes
RAS-(4-6)WH(V)NPE	2.27
RAS-8WHNPE	3.16
RAS-10WHNPE	4.11

- 4 Pay special attention to the place, such as a basement, etc., where the refrigerant can stay, since refrigerant is heavier than air.

Example:

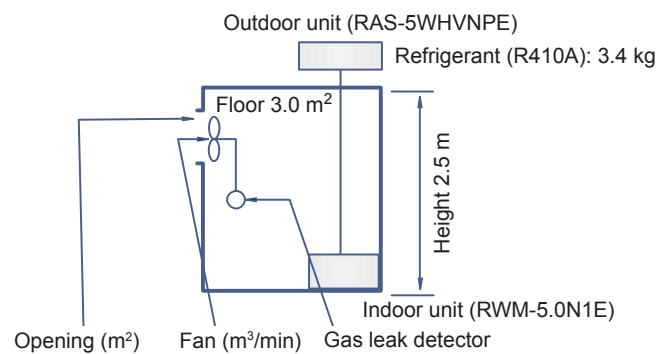

R (kg)	V (m ³)	C (kg/m ³)	Countermeasure
3.4	7.5	0.46	1.0 m ³ /min fan linked with gas leak detector or 0.5 m ² opening

8.4 Space heating and DHW

DANGER

Do not connect the power supply to the indoor unit prior to filling the space heating and DHW circuits with water and checking water pressure and the total absence of any water leakage.

8.4.1 Additional hydraulic necessary elements for space heating

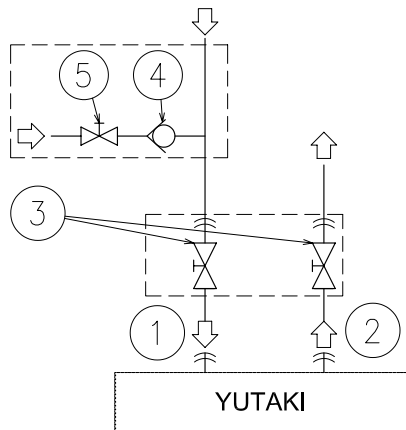

Type	N°	Part name
Piping connections	1	Water inlet (Space heating)
	2	Water outlet (Space heating)
Factory supplied	3	Shut-off valve (factory-supplied)
Accessories	4	Water check valve (ATW-WCV-01 accessory)
Field supplied	5	Shut-off valve

The following hydraulic elements are necessary to correctly perform the space heating water circuit:

- **Two shut-off valves (factory supplied accessory) (3)** must be installed in the indoor unit. One at the water inlet connection (1) and the other at the water outlet connection (2) in order to make easier any maintenance work.
- **A water check valve (ATW-WCV-01 accessory) (4)** with 1 shut-off valve (field supplied) (5) must be connected to the water filling point when filling the indoor unit. The check valve acts as a safety device to protect the installation against back pressure, back flow and back syphon of non-potable water into drinking water supply net.

8.4.2 Additional hydraulic necessary elements for DHW

The next hydraulic elements are necessary to correctly perform the domestic hot water circuit:

◆ COMMON

The following elements are required for all YUTAKI units.

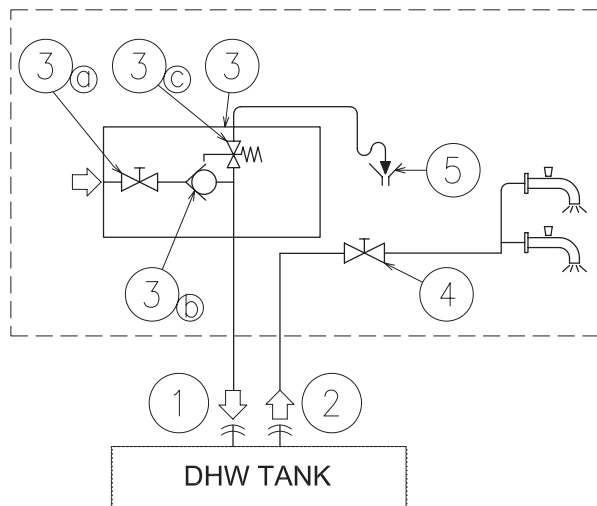

Type	N°	Part name	
Piping connections	1	Water inlet (DHW)	
	2	Water outlet (DHW)	
Field supplied	3	Pressure and temperature relief valve	
		3a	Shut-off valve
		3b	Water check valve
	3c	Pressure relief valve	
	4	Shut-off valve	
5	Draining		

- **1 Shut-off valve (field supplied):** one shut-off valve (4) must be connected after the DHW outlet connection of the DHW tank (2) in order to make easier any maintenance work.
- **A Security water valve (Field-supplied):** this accessory (3) is a pressure and temperature relief valve that must be installed as near as possible to the DHW inlet connection of the DHW tank (1). It should ensure a correct draining (5) for the discharge valve of this valve. This security water valve should provide the following:
 - Pressure protection
 - Non-return function
 - Shut-off valve
 - Filling
 - Draining

i NOTE

The discharge pipe should always be open to the atmosphere, free of frost and in continuous slope to the down side in case that water leakage exists.

◆ YUTAKI S

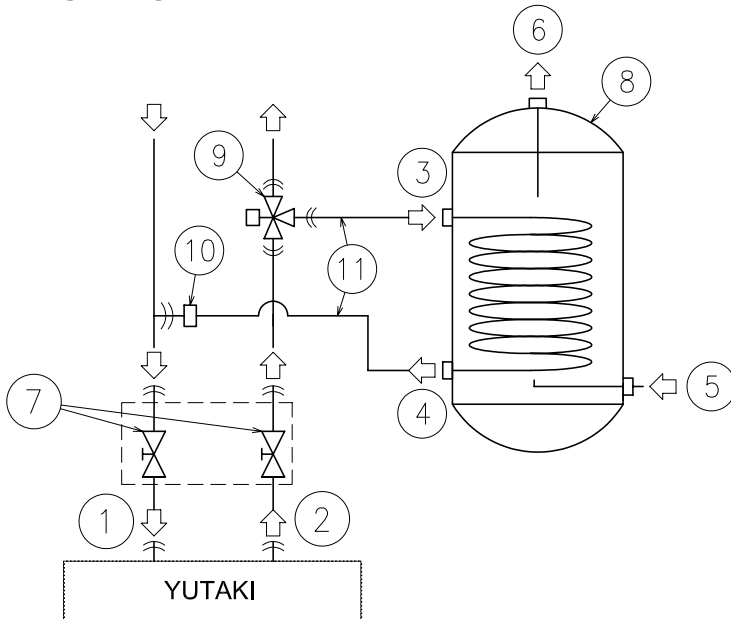

Type	N°	Part name
Piping connections	1	Water inlet (Space heating)
	2	Water outlet (Space heating)
	3	Heating coil inlet
	4	Heating coil outlet
	5	Water inlet (DHW)
	6	Water outlet (DHW)
Factory supplied	7	Shut-off valve (factory-supplied)
Accessories	8	Domestic hot water tank DHWT-(200/300)S-3.0H2E accessory
	9	3-way valve (ATW-3WV-01 accessory)
Field supplied	10	T-branch
	11	Heating coil pipes

YUTAKI S is not factory-supplied ready for DHW operation, but they can be used for the production of DHW if the following elements are installed:

- **A domestic hot water tank (DHWT-(200/300)S-3.0H2E accessory) (8)** has to be installed in combination with the indoor unit.
- **A 3-way valve (ATW-3WV-01 accessory) (9)** must be connected at one point of the water outlet pipe of the installation.
- **A T-branch (field supplied) (10)** must be connected at one point of the water inlet pipe of the installation.
- **Two water pipes (field supplied) (11)**. One pipe between 3-way valve and the heating coil inlet (3) of the DHW tank, the other one between the T-branch and the heating coil outlet (4) of the DHW tank.

◆ YUTAKI S COMBI

YUTAKI S COMBI is factory-supplied ready for DHW operation (Fitted with DHW tank and 3-way valve). Only the "Common" elements are required.

8.4.3 Additional hydraulic optional elements (For DHW)

In case of a recirculation circuit for the DHW circuit:

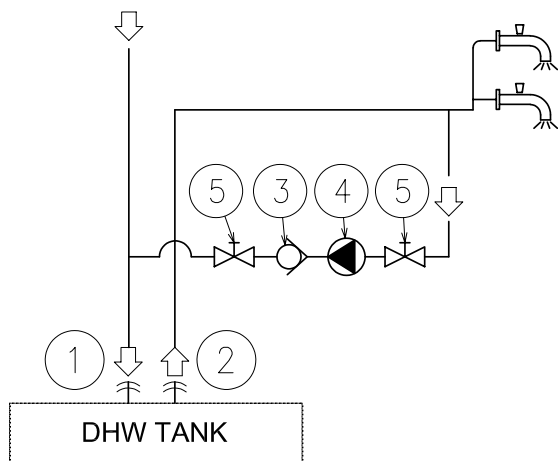

Type	N°	Part name
Piping connections	1	Water inlet (DHW)
	2	Water outlet (DHW)
Accessories	3	Water check valve (ATW-WCV-01 accessory)
Field supplied	4	Water pump
	5	Shut-off valve

- **1 Recirculation water pump (field supplied):** this water pump (3) will help to correctly recirculate the hot water to the DHW inlet.
- **1 Water check valve (ATW-WCV-01 accessory):** this Hitachi accessory (4) is connected after the recirculation water pump (31) in order to ensure the non-return of water.
- **2 Shut-off valves (field supplied) (5):** one before the recirculation water pump (3) and other after the water check valve accessory (4).

8.4.4 Additional hydraulic necessary elements for DHW (only for UK market)

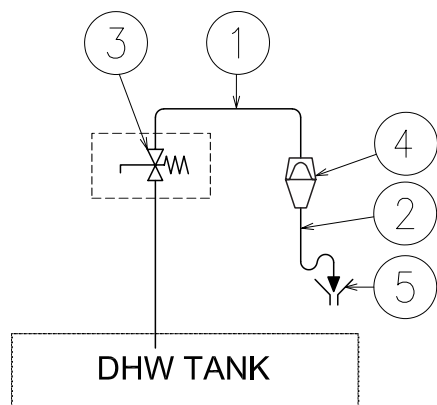

Type	N°	Part name
Piping connections	1	T&P relief valve outlet pipe Ø15 (factory supplied)
	2	Tundish outlet pipe (Field supplied)
Accessories	3	Pressure and Temperature relief valve (Factory supplied)
Field supplied	4	Tundish (Field supplied)
	5	Drain (Field supplied)

The following accessories are necessary for the compliance of the YUTAKI S COMBI for UK market with the UK requirements referred in the UK Building Regulations 2000.

- **1 temperature and pressure relief valve (factory supplied),** fitted at the hottest part of the DHW tank. This device protects the unit of excessive temperature (>96° C) and excessive pressure (>7 bar) in the DHW tank. Additionally, a Ø15 diameter pipe (factory supplied) is fitted to the outlet of the relief valve and drives the discharge to the tundish (4).
- **1 Tundish(4)(field supplied),** installed in a vertical position, with no more than 600 mm of pipe between the valve outlet and the tundish.
- **1 Tundish outlet pipe (2)(field supplied)** with a vertical section at least 300 mm long below the tundish(4), before any elbows or bends in the pipework. This pipe should be made of metal or other material that has been demonstrated to be capable of safely withstanding temperatures and pressure of the water discharged, as it is referred in the UK Building Regulations.
- The discharge pipe from the tundish (2) must terminate in a safe place where there is no risk to persons in the vicinity of the discharge. The discharge will consist of high water temperature and pressure.

8.4.5 Requirements and recommendations for the hydraulic circuit

- The maximum piping length depends on the maximum pressure availability in the water outlet pipe. Please check the pump curves.
- The indoor unit is equipped with an air purger (factory supplied) at the highest location of the Indoor Unit. If this location is not the highest of the water installation, air might be trapped inside the water pipes, which could cause system malfunction. In that case additional air purgers (field supplied) should be installed to ensure no air enters the water circuit.
- For heating floor system, the air should be purged by means of an external pump and an open circuit to avoid air bags.
- When the unit is stopped during shut-off periods and the ambient temperature is very low, the water inside the pipes and the circulating pump may freeze, thus damaging the pipes and the water pump. In these cases, the installer shall ensure that the water temperature inside the pipes does not fall below the freezing point. In order to prevent this, the unit has a self-protection mechanism which should be activated (refer to the Service manual, "Optional functions" chapter).
- Check that the water pump of the space heating circuit works within the pump operating range and that the water flow is over the pump's minimum. If the water flow is below 6 litres/minute for 2.0/2.5/3.0HP units or 12 litres/minute for 4.0/5.0/6.0 units, alarm is displayed on the unit.
- An additional special water filter is highly recommended to be installed on the space heating (field installation), in order to remove possible particles remaining from brazing which cannot be removed by the indoor unit water strainer.
- When selecting a DHW tank, take into consideration the following points:
 - The storage capacity of the tank has to meet with the daily consumption in order to avoid stagnation of water.
 - Fresh water must circulate inside the DHW tank water circuit at least one time per day during the first days after the installation has been performed. Additionally, flush the system with fresh water when there is no consumption of DHW during long periods of time.
 - Try to avoid long runs of water piping between the tank and the DHW installation in order to decrease possible temperature losses.
 - If the domestic cold water entry pressure is higher than the equipment's design pressure (6 bar), a pressure reducer must be fitted with a nominal value of 7 bar.
- Ensure that the installation complies with applicable legislation in terms of piping connection and materials, hygienic measures, testing and the possible required use of some specific components like thermostatic mixing valves, Differential pressure overflow valve, etc.
- The maximum water pressure is 3 bar (nominal opening pressure of the safety valve). Provide adequate reduction pressure device in the water circuit to ensure that the maximum pressure is NOT exceeded.
- Ensure that the drain pipes connected to the safety valve and to the air purger are properly driven to avoid water being in contact with unit components.
- Make sure that all field supplied components installed in the piping circuit can withstand the water pressure and the water temperature range in which the unit can operate.
- YUTAKI units are conceived for exclusive use in a closed water circuit.
- The internal air pressure of the expansion vessel tank will be adapted to the water volume of the final installation (factory supplied with 0.1 MPa of internal air pressure).
- Do not add any type of glycol to the water circuit.
- Drain taps must be provided at all low points of the installation to permit complete drainage of the circuit during servicing.

8.4.6 Water piping

◆ Water piping length

Consider the following guidelines when designing the water circuit.

Item	YUTAKI S	YUTAKI S COMBI
Maximum water piping length between indoor unit and DHW tank	10 m	--
Maximum water piping length between indoor unit and 3-way valve	3 m	--
Maximum water piping length between 3-way valve and DHW tank	10 m	--



NOTE

DHW Piping length. It is recommended to avoid long runs of piping between the domestic hot water tank and hot water outlet side in order to avoid heat losses.

◆ Water piping size

YUTAKI S

(inches)

Model	Space heating pipes connection		
	Inlet connection	Outlet connection	Shut-off valves
(2.0-3.0)HP	G 1" (female)	G 1" (female)	G 1" (male) - G 1" (male)
(4.0-10.0)HP	G 1-1/4" (female)	G 1-1/4" (female)	G 1-1/4" (male) - G 1-1/4" (male)

YUTAKI S COMBI

(inches)

Model	Space heating connection			DHW connection		
	Inlet connection	Outlet connection	Shut-off valves	Inlet connection	Outlet connection	P & T relief valve (*)
(2.0-3.0)HP	G 1" (female)	G 1" (female)	G 1" (male) - G 1" (male)	G 3/4" (female)	G 3/4" (female)	Ø15 mm
(4.0-6.0)HP	G 1-1/4" (female)	G 1-1/4" (female)	G 1-1/4" (male) - G 1-1/4" (male)	G 3/4" (female)	G 3/4" (female)	Ø15 mm

(*): Only for models for UK market.

8.4.7 Water quality

CAUTION

- Water quality must be according to EU council directive 98/83 EC.
- Water should be subjected to filtration or to a softening treatment with chemicals before application as treated water.
- It is also necessary to analyse the quality of water by checking pH, electrical conductivity, ammonia ion content, sulphur content, and others. Should the results of the analysis be not good, the use of industrial water would be recommended.
- No antifreeze agent shall be added to the water circuit.
- To avoid deposits of scale on the heat exchangers surface it is mandatory to ensure a high water quality with low levels of CaCO₃.

◆ Recommendations for the DHW circuit

The following is the recommended standard water quality.

Item	DHW space	Tendency ⁽¹⁾	
	Water supplied ⁽³⁾	Corrosion	Deposits of scales
Electrical Conductivity (mS/m) (25°C) {μS/cm} (25 °C) ⁽²⁾	100~2000	●	●
Chlorine Ion (mg Cl ⁻ /l)	max. 250	●	
Sulphate (mg/l)	max. 250	●	
Combination of chloride and sulphate (mg/l)	max. 300	●	●
Total Hardness (mg CaCO ₃ /l)	60~150		●

NOTE

- (1): The mark “●” in the table means the factor concerned with the tendency of corrosion or deposits of scales.
- (2): The value shown in “{ }” are for reference only according to the former unit.
- (3): Water range will be according s/UNE 112076:2004 IN.

9 . Electrical and control settings

Index

9.1	General check	118
9.1.1	Split system - Outdoor unit	118
9.1.2	Split system - Indoor unit	118
9.2	System wiring diagram	120
9.3	Electrical connection	121
9.3.1	Wiring size	121
9.3.2	Minimum requirements of the protection devices	122
9.4	Transmission wiring	125
9.4.1	YUTAKI units	125
9.5	Optional indoor unit wiring (accessories)	126
9.5.1	Summary of the terminal board connections for YUTAKI units	126
9.6	Setting of DIP switches and RSW switches	132
9.6.1	Outdoor unit	132
9.6.1.1	Location of DIP switches and rotary switches	132
9.6.1.2	Function of DIP switches and rotary switches	132
9.6.1.3	LED indication	135
9.6.2	YUTAKI unit	136
9.6.2.1	Location of DIP switches and rotary switches	136
9.6.2.2	Function of DIP switches and rotary switches	136
9.6.2.3	LED indication	139

9.1 General check

- Make sure that the following conditions related to power supply installation are satisfied:
 - The power capacity of the electrical installation is large enough to support the power demand of the YUTAKI system (outdoor unit + indoor unit + DHW tank (if apply)).
 - The power supply voltage is within $\pm 10\%$ of the rated voltage.
 - The impedance of the power supply line is low enough to avoid any voltage drop of more than 15% of the rated voltage.
- Following the Council Directive 2014/30/EU, relating to electromagnetic compatibility, the table below indicates the Maximum permitted system impedance Z_{max} at the interface point of the user's supply, in accordance with EN 61000-3-11.

9.1.1 Split system - Outdoor unit

Model	Power supply	Z_{max} (Ω)
RAS-2WHVRP1	1~ 230V 50Hz	-
RAS-2.5WHVRP1		-
RAS-3WHVRP1		0.43
RAS-4WHVNPE		0.25
RAS-5WHVNPE		0.25
RAS-6WHVNPE		0.25

Model	Power supply	Z_{max} (Ω)
RAS-4WHNPE	3N~ 400V 50Hz	-
RAS-5WHNPE		-
RAS-6WHNPE		-
RAS-8WHNPE		-
RAS-10WHNPE		-

9.1.2 Split system - Indoor unit

◆ YUTAKI S

Model	Power supply	Operation mode	Z_{max} (Ω)
RWM-(2.0-3.0)R1E	1~ 230V 50Hz	Without electric heaters	-
		With electric heater	-
		With DHW tank heater	-
		With electric and DHW tank heaters	0.28
	3N~ 400V 50Hz	Without electric heaters	-
		With electric heater	-
		With DHW tank heater	-
		With electric and DHW tank heaters	-
RWM-(4.0-6.0)N1E	1~ 230V 50Hz	Without electric heaters	-
		With electric heater	0.28
		With DHW tank heater	-
		With electric and DHW tank heaters	0.19
	3N~ 400V 50Hz	Without electric heaters	-
		With electric heater	-
		With DHW tank heater	-
		With electric and DHW tank heaters	-
RWM-(8.0-10.0)N1E	3N~ 400V 50Hz	Without electric heaters	-
		With electric heater	-
		With DHW tank heater	-
		With electric and DHW tank heaters	-

NOTE

- The data corresponding to DHW tank heater is calculated in combination with the domestic hot water tank accessory "DHWT-(200/300)S-3.0H2E".
- In case of three phases connection, Z_{max} is not considered.

◆ YUTAKI S COMBI

Model	Power supply	Operation mode	Z _{max} (Ω)
RWD-(2.0-3.0) RW1E-220S(-K)	1~ 230V 50Hz	Without electric heaters	-
		With electric heater	-
		With DHW tank heater	-
		With electric and DHW tank heaters	0.29
	3N~ 400V 50Hz	Without electric heaters	-
		With electric heater	-
		With DHW tank heater	-
		With electric and DHW tank heaters	-
RWD-(4.0-6.0) NW1E-220S(-K)	1~ 230V 50Hz	Without electric heaters	-
		With electric heater	0.28
		With DHW tank heater	-
		With electric and DHW tank heaters	0.19
	3N~ 400V 50Hz	Without electric heaters	-
		With electric heater	-
		With DHW tank heater	-
		With electric and DHW tank heaters	-

i NOTE

The data corresponding to DHW tank heater is calculated in combination with the domestic hot water tank accessory "DHWT-(200/300)S-3.0H2E".

- The status of Harmonics for each model, regarding compliance with EN 61000-3-2 and EN 61000-3-12, is as follows:

Status regarding compliance with EN 61000-3-2 and EN 61000-3-12	Models		
	Split system		
	Outdoor unit	Indoor unit	
		YUTAKI S	YUTAKI S COMBI
Equipment complying with EN 61000-3-2 (*): Professional use	RAS-2WHVRP1(*) RAS-2.5WHVRP1(*) RAS-3WHVRP1 (*) RAS-4WHNPE (*) RAS-5WHNPE (*) RAS-6WHNPE (*)	RWM-2.0R1E (1~, 3N~) RWM-2.5R1E (1~, 3N~) RWM-3.0R1E (1~, 3N~) RWM-4.0N1E (3N~) RWM-5.0N1E (3N~) RWM-6.0N1E (3N~) RWM-8.0N1E RWM-10.0N1E	-
Equipment complying with EN 61000-3-12	RAS-4WH(V)NPE RAS-5WH(V)NPE RAS-6WH(V)NPE	RWM-4.0N1E (1~) RWM-5.0N1E (1~) RWM-6.0N1E (1~)	RWD-2.0R1WE-220S(-K) RWD-2.5R1WE-220S(-K) RWD-3.0R1WE-220S(-K) RWD-4.0NW1E-220S(-K) RWD-5.0NW1E-220S(-K) RWD-6.0NW1E-220S(-K)
Installation restrictions may be applied by supply authorities in relation to harmonics	RAS-8WHNPE RAS-10WHNPE	-	-

- Check to ensure that existing installation (mains power switches, circuit breakers, wires, connectors and wire terminals) already complies with the national and local regulations.
- The use of the DHW tank heater is disabled as factory setting. If it is desired to enable the DHW tank heater operation during normal indoor unit operation, adjust the DSW4 pin 3 of the PCB1 to the ON position and use the adequate protections. Refer to the section "9.3 Electrical connection" for the detailed information.

9.2 System wiring diagram

Connect the units according to the following electric diagram:

- | | |
|-----------------------------|------------------------------------|
| TB : Terminal board | — : Field wiring |
| CB : Circuit breaker | ⊗ : Field-supplied |
| ELB : Earth leakage breaker | 1,2 : Outdoor-Indoor communication |
| --- : Internal wiring | |

YUTAKI (S / S COMBI)

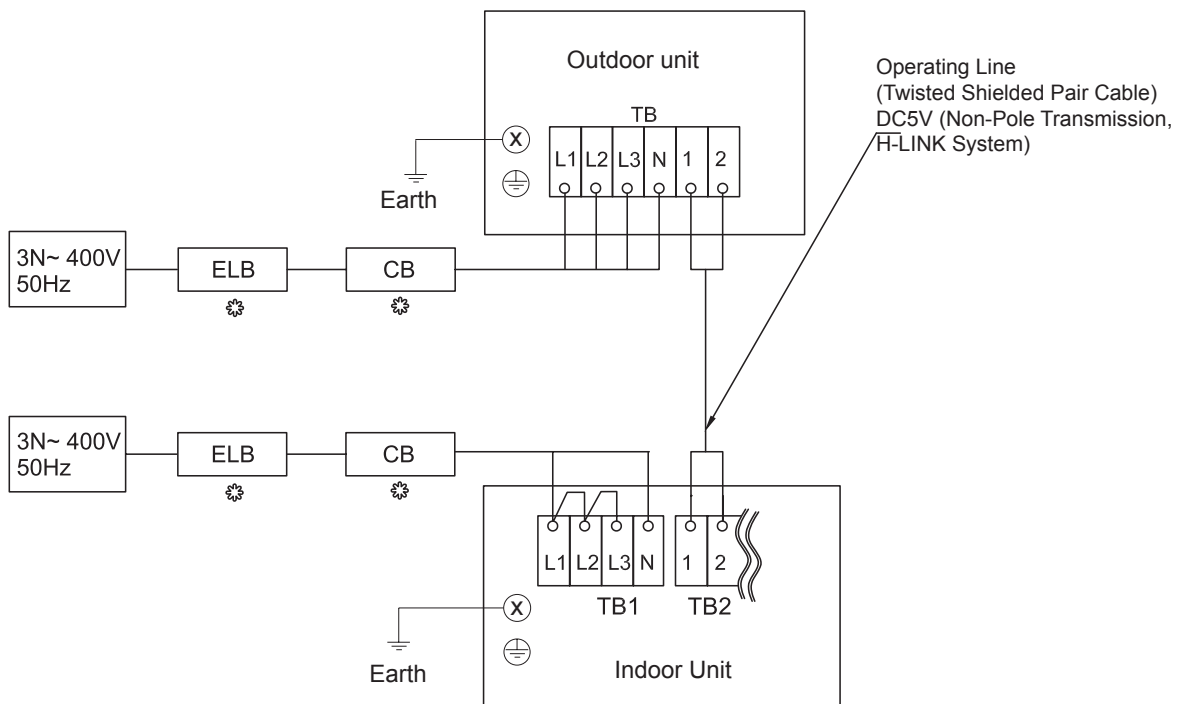
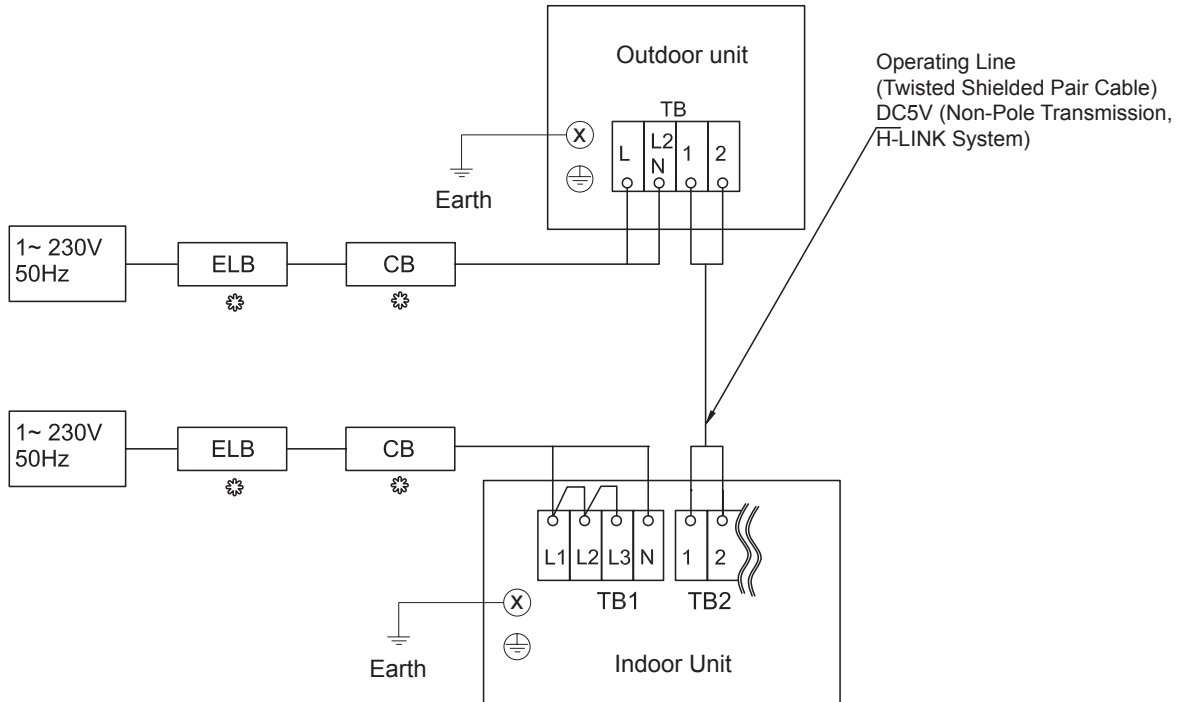

9.3 Electrical connection

CAUTION

- Check to ensure that the field supplied electrical components (mains power switches, circuit breakers, wires, connectors and wire terminals) have been properly selected according to the electrical data indicated on this chapter and they comply with national and local codes. If it is necessary, contact with your local authority in regards to standards, rules, regulations, etc.
- Use a dedicated power circuit for the indoor unit. Do not use a power circuit shared with the outdoor unit or any other appliance.

9.3.1 Wiring size

Use wires which are not lighter than the polychloroprene sheathed flexible cord (code designation 60245 IEC 57).

◆ Split system - Outdoor unit

Model	Power supply	Power supply cables	Transmitting cables	Actuator cables
		EN 60335-1	EN 60335-1	EN 60335-1
RAS-2WHVRP1	1~ 230V 50Hz	2 x 2.5 mm ² + GND	2 x 0.75 mm ² (Shielded cable)	2 x 0.75 mm ² + GND
RAS-2.5WHVRP1		2 x 2.5 mm ² + GND		
RAS-3WHVRP1		2 x 4.0 mm ² + GND		
RAS-4WHVNPE		2 x 10.0 mm ² + GND		
RAS-5WHVNPE		2 x 10.0 mm ² + GND		
RAS-6WHVNPE		2 x 10.0 mm ² + GND		
RAS-4WHNPE	3N~ 400V 50Hz	4 x 4.0 mm ² + GND		
RAS-5WHNPE		4 x 4.0 mm ² + GND		
RAS-6WHNPE		4 x 4.0 mm ² + GND		
RAS-8WHNPE		4 x 6.0 mm ² + GND		
RAS-10WHNPE		4 x 6.0 mm ² + GND		

◆ Split system - Indoor unit

YUTAKI S

Model	Power supply	Operation mode	Power supply cables	Transmitting cables	Actuator cables
			EN 60335-1	EN 60335-1	EN 60335-1
RWM-(2.0-3.0)R1E	1~ 230V 50Hz	Without electric heaters	2 x 0.75 mm ² + GND	2 x 0.75 mm ²	2 x 0.75mm ² + GND
		With electric heater	2 x 2.5 mm ² + GND		
		With DHW tank heater	2 x 2.5 mm ² + GND		
		With electric and DHW tank heaters	2 x 6.0 mm ² + GND		
	3N~ 400V 50Hz	Without electric heaters	4 x 0.75mm ² + GND		
		With electric heater	4 x 2.5 mm ² + GND		
		With DHW tank heater	4 x 4.0 mm ² + GND		
		With electric and DHW tank heaters	4 x 6.0 mm ² + GND		
RWM-(4.0-6.0)N1E	1~ 230V 50Hz	Without electric heaters	2 x 0.75 mm ² + GND		
		With electric heater	2 x 6.0 mm ² + GND		
		With DHW tank heater	2 x 2.5 mm ² + GND		
		With electric and DHW tank heaters	2 x 10.0 mm ² + GND		
	3N~ 400V 50Hz	Without electric heaters	4 x 0.75 mm ² + GND		
		With electric heater	4 x 2.5 mm ² + GND		
		With DHW tank heater	4 x 2.5 mm ² + GND		
		With electric and DHW tank heaters	4 x 6.0 mm ² + GND		
RWM-(8.0-10.0) N1E	3N~ 400V 50Hz	Without electric heaters	4 x 0.75 mm ² + GND		
		With electric heater	4 x 4.0 mm ² + GND		
		With DHW tank heater	4 x 4.0 mm ² + GND		
		With electric and DHW tank heaters	4 x 10.0 mm ² + GND		

NOTE

The data corresponding to DHW tank heater is calculated in combination with the domestic hot water tank accessory "DHWT-(200/300)S-3.0H2E".

YUTAKI S COMBI

Model	Power supply	Operation mode	Power supply cables	Transmitting cables	Actuator cables
			EN 60335-1	EN 60335-1	EN 60335-1
RWD-(2.0-3.0) RW1E-220S(-K)	1~ 230V 50Hz	Without electric heaters	2 x 0.75 mm ² + GND	2 x 0.75 mm ²	2 x 0.75 mm ² + GND
		With electric heater	2 x 2.5 mm ² + GND		
		With DHW tank heater	2 x 2.5 mm ² + GND		
		With electric and DHW tank heaters	2 x 6.0 mm ² + GND		
	3N~ 400V 50Hz	Without electric heaters	4 x 0.75 mm ² + GND		
		With electric heater	4 x 2.5 mm ² + GND		
		With DHW tank heater	4 x 2.5 mm ² + GND		
		With electric and DHW tank heaters	4 x 2.5 mm ² + GND		
RWD-(4.0-6.0) NW1E-220S(-K)	1~ 230V 50Hz	Without electric heaters	2 x 0.75 mm ² + GND		
		With electric heater	2 x 6.0 mm ² + GND		
		With DHW tank heater	2 x 2.5 mm ² + GND		
		With electric and DHW tank heaters	2 x 10.0 mm ² + GND		
	3N~ 400V 50Hz	Without electric heaters	4 x 0.75 mm ² + GND		
		With electric heater	4 x 6.0 mm ² + GND		
		With DHW tank heater	4 x 2.5 mm ² + GND		
		With electric and DHW tank heaters	4 x 6.0 mm ² + GND		

**NOTE**

The data corresponding to DHW tank heater is calculated in combination with the domestic hot water tank accessory "DHWT-(200/300)S-3.0H2E".

9.3.2 Minimum requirements of the protection devices**CAUTION**

- Ensure specifically that there is an Earth Leakage Breaker (ELB) installed for the units (outdoor and indoor unit).
- If the installation is already equipped with an Earth Leakage Breaker (ELB), ensure that its rated current is large enough to hold the current of the units (outdoor and indoor unit).

**NOTE**

- Electric fuses can be used instead of magnetic Circuit Breakers (CB). In that case, select fuses with similar rated values as the CB.
- The Earth Leakage Breaker (ELB) mentioned on this manual is also commonly known as Residual Current Device (RCD) or Residual Current Circuit Breaker (RCCB).
- The Circuit Breakers (CB) are also known as Thermal-Magnetic Circuit Breakers or just Magnetic Circuit Breakers (MCB).

◆ Split system - Outdoor unit

Model	Power supply	Applicable voltage		CB (A)	ELB (n° of poles/A/mA)
		U max. (V)	U min. (V)		
RAS-2WHVRP1	1~ 230V 50Hz	253	207	16	2/40/30
RAS-2.5WHVRP1				16	
RAS-3WHVRP1				20	
RAS-4WHVNPE				32	
RAS-5WHVNPE				32	
RAS-6WHVNPE				32	
RAS-4WHNPE	3N~ 400V 50Hz	440	360	15	4/40/30
RAS-5WHNPE				15	
RAS-6WHNPE				20	
RAS-8WHNPE				25	
RAS-10WHNPE				25	

MC: Maximum current; CB: Circuit breaker; ELB: Earth leakage breaker

◆ Split system - Indoor unit

YUTAKI S

Model	Power supply	Applicable voltage		Operation mode	CB (A)	ELB (n° of poles/A/ mA)
		U max. (V)	U min. (V)			
RWM-(2.0-3.0)R1E	1~ 230V 50Hz	253	207	Without electric heaters	5	2/40/30
				With electric heater	16	
				With DHW tank heater	16	
				With electric and DHW tank heaters	32	
	3N~ 400V 50Hz	440	360	Without electric heaters	5	4/40/30
				With electric heater	10	
				With DHW tank heater	20	
				With electric and DHW tank heaters	25	
RWM-(4.0-6.0)N1E	1~ 230V 50Hz	253	207	Without electric heaters	5	2/40/30
				With electric heater	32	
				With DHW tank heater	16	
				With electric and DHW tank heaters	50	
	3N~ 400V 50Hz	440	360	Without electric heaters	5	4/40/30
				With electric heater	15	
				With DHW tank heater	15	
				With electric and DHW tank heaters	25	
RWM-(8.0-10.0)N1E	3N~ 400V 50Hz	440	360	Without electric heaters	5	4/40/30
				With electric heater	20	
				With DHW tank heater	20	
				With electric and DHW tank heaters	30	

 **NOTE**

The data corresponding to DHW tank heater is calculated in combination with the domestic hot water tank accessory "DHWT-(200/300)S-3.0H2E".

 **CAUTION**

- Ensure specifically that there is an Earth Leakage Breaker (ELB) installed for the units (outdoor and indoor unit).
- If the installation is already equipped with an Earth Leakage Breaker (ELB), ensure that its rated current is large enough to hold the current of the units (outdoor and indoor unit)

 **NOTE**

- Electric fuses can be used instead of magnetic Circuit Breakers (CB). In that case, select fuses with similar rated values as the CB.
- The Earth Leakage Breaker (ELB) mentioned on this manual is also commonly known as Residual Current Device (RCD) or Residual Current Circuit Breaker (RCCB).
- The Circuit Breakers (CB) are also known as Thermal-Magnetic Circuit Breakers or just Magnetic Circuit Breakers (MCB).

YUTAKI S COMBI

Model	Power supply	Applicable voltage		Operation mode	CB (A)	ELB (n° of poles/A/mA)
		U max. (V)	U min. (V)			
RWD-(2.0-3.0)-RW1E-220S(-K)	1~ 230V 50Hz	253	207	Without electric heaters	5	2/40/30
				With electric heater	16	
				With DHW tank heater	16	
				With electric and DHW tank heaters	32	
	3N~ 400V 50Hz	440	360	Without electric heaters	5	4/40/30
				With electric heater	15	
				With DHW tank heater	15	
				With electric and DHW tank heaters	15	
RWD-(4.0-6.0)NW1E-220S(-K)	1~ 230V 50Hz	253	207	Without electric heaters	5	2/40/30
				With electric heater	32	
				With DHW tank heater	16	
				With electric and DHW tank heaters	50	
	3N~ 400V 50Hz	440	360	Without electric heaters	5	4/40/30
				With electric heater	25	
				With DHW tank heater	15	
				With electric and DHW tank heaters	25	

⚠ CAUTION

- Ensure specifically that there is an Earth Leakage Breaker (ELB) installed for the units (outdoor and indoor unit).
- If the installation is already equipped with an Earth Leakage Breaker (ELB), ensure that its rated current is large enough to hold the current of the units (outdoor and indoor unit)

i NOTE

- Electric fuses can be used instead of magnetic Circuit Breakers (CB). In that case, select fuses with similar rated values as the CB.
- The Earth Leakage Breaker (ELB) mentioned on this manual is also commonly known as Residual Current Device (RCD) or Residual Current Circuit Breaker (RCCB).
- The Circuit Breakers (CB) are also known as Thermal-Magnetic Circuit Breakers or just Magnetic Circuit Breakers (MCB).

9.4 Transmission wiring

9.4.1 YUTAKI units

- This is the transmission wiring between outdoor and indoor unit, ATW-RTU communication and Central devices.
- The transmission is wired to terminals 1-2.
- The H-LINK II wiring system requires only two transmission cables that connect the indoor unit and the outdoor unit.

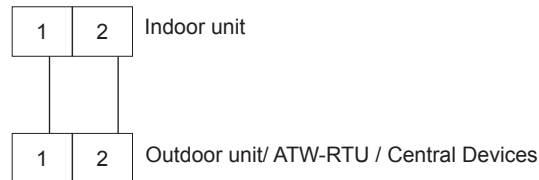

NOTE

- Use twist pair wires (0.75 mm²) for operation wiring between outdoor unit and indoor unit. The wiring must consist of 2-core wires (Do not use wire with more than 3 cores).
- Use shielded wires for intermediate wiring to protect the units from noise interference, with a length of less than 300m and a size in compliance with local codes.
- In the event that a conduit tube for field-wiring is not used, fix rubber bushes to the panel with adhesive.

CAUTION

Ensure that the transmission wiring is not wrongly connected to any live part that could be damaged the PCB.

9.5 Optional indoor unit wiring (accessories)

9.5.1 Summary of the terminal board connections for YUTAKI units

◆ YUTAKI S

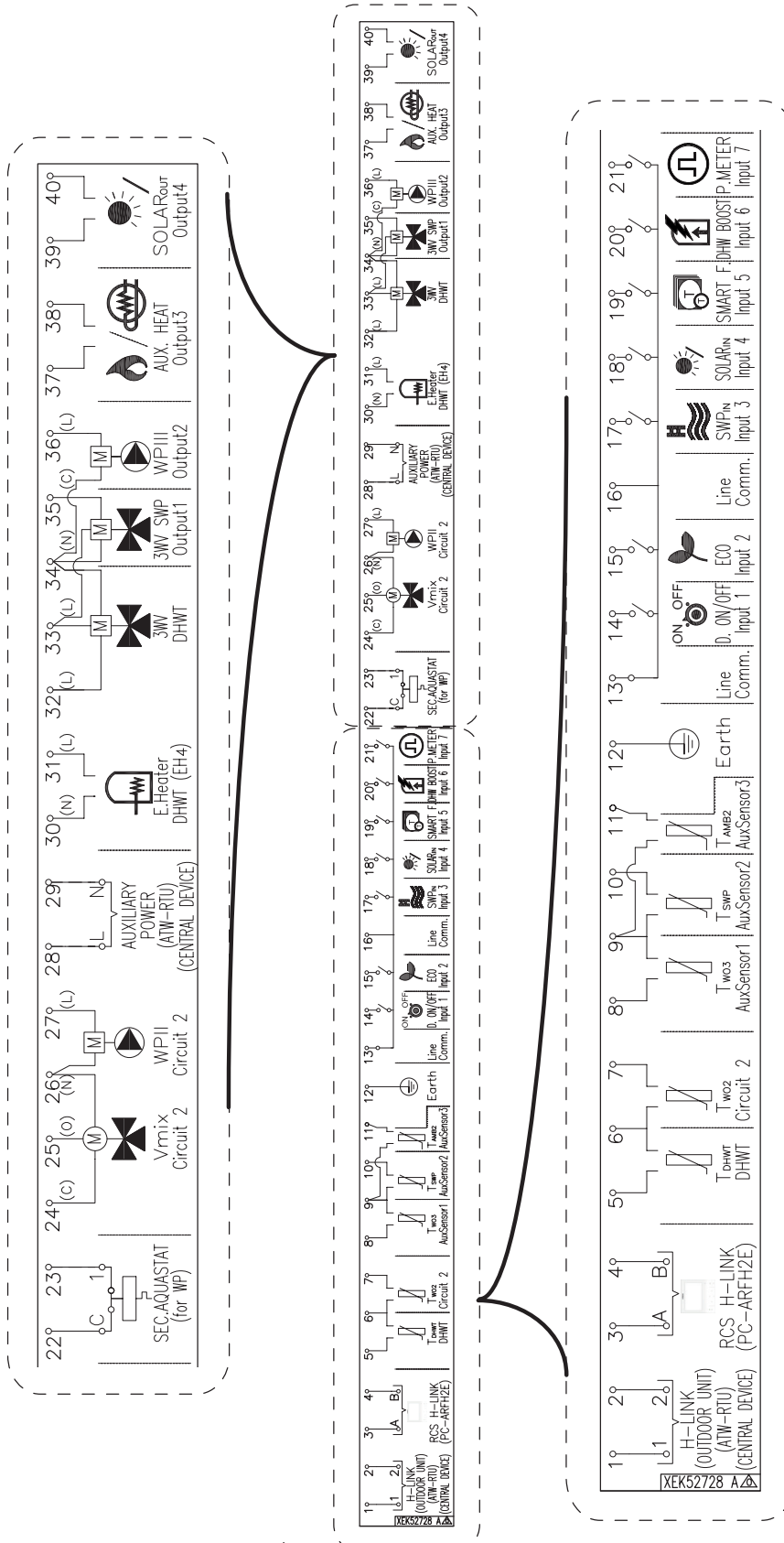

Mark	Part name	Description
TERMINAL BOARD 1 (TB1)		
N	1~ 230V 50Hz 3N~ 400V 50Hz	Main power supply connection
L1		
L2		
L3		
TERMINAL BOARD 2 (TB2)		
1	H-LINK commutation	The H-LINK transmission has to be done between the indoor unit and the terminals 1-2 of either outdoor unit, ATW-RTU or any other central device.
2		
3	H-LINK communication for remote control switch	Terminals for the connection of the YUTAKI unit controller.
4		
5	DHW tank's thermistor	The DHW sensor is used to control the temperature of the domestic hot water tank.
6	Common thermistor	Common terminal for thermistor.
7	Thermistor for water outlet temperature of second cycle	The sensor is used for the second temperature control and should be positioned after the mixing valve and the circulation pump.
8	Thermistor for water outlet temperature after hydraulic separator	Water sensor for hydraulic separator, buffer tank or boiler combination.
9	Common thermistor	Common terminal for thermistors.
10	Thermistor for swimming pool water temperature	The sensor is used for the swimming pool temperature control and should be positioned inside plate heat exchanger of the swimming pool.
11	Thermistor for second ambient temperature	The sensor is used for the second ambient temperature control and it should be positioned outdoors.
12	Earth	Earth connection for the 3 way valve and water pump NEW
13	Common line	Terminal Line common for input 1 and input 2.
14	Input 1 (Demand ON/OFF) (*)	The air to water heat pump system has been designed to allow the connection of a remote thermostat to effectively control your home's temperature. Depending on the room temperature, the thermostat will turn the split air to water heat pump system ON and OFF.
15	Input 2 (ECO mode) (*)	Available signal which allows to reduce the water setting temperature of circuit 1, circuit 2 or both.
16	Common line	Terminal Line common for inputs 3, 4, 5, 6, 7.
17	Input 3 (Swimming pool) (*)	Only for swimming pool installations: It is necessary to connect an external input to the air to water heat pump to provide signal when the water pump of swimming pool is ON.
18	Input 4 (Solar) (*)	Available input for Solar combination with Domestic Hot Water Tank.
19	Input 5 (Smart function) (*)	For the connection of an external tariff switch device to switch OFF the heat pump during peak electricity demand period. Depending on the setting, the heat pump or DHWT will be blocked when signal is open/closed.
20	Input 6 (DHW boost) (*)	Available input for an instantaneous heating of the domestic hot water of the tank.
21	Input 7 (Power meter)	The measuring of the real power consumption can be done connecting an external power meter. The number of pulses of the power meter is a variable which must be set. By this, every pulse input is added into corresponding operation mode (Heating, Cooling, DHW Operation). Two possible options: - One power meter for all installation (IU+OU). - Two separated power meters (one for IU and one for OU).
22	Aquastat security for circuit 1 (WP1)	Terminals intended for the connection of the Aquastat security accessory (ATW-AQT-01) for controlling water temperature of the circuit 1.
23		
24(C)	Mixing valve close	When a mixing system is required for a second temperature control, these outputs are necessary to control the mixing valve.
25(O)	Mixing valve open	
26(N)	N Common	
27(L)	Water Pump 2 (WP2)	When there is a second temperature application, a secondary pump is the circulating pump for the secondary heating circuit.
28	Auxiliary power	Power supply for ATW-RTU and central device NEW
29		

Mark	Part name	Description
30(N)	Electrical Heater DHW Output	If DHW tank contains an electric heater, the air to water heat pump can activate it if the heat pump cannot achieve the required DHW temperature by itself.
31(L)		
32(C)	Common line	Common terminal for the 3-way valve for DHW tank.
33(L)	3-way valve for DHW tank	The air to water heat pump can be used to heat DHW. This output will be on when DHW is activated.
34(N)	N common	Neutral terminal common for 3-way valve of DHW tank and outputs 1 and 2.
35(L)	Output 1 (3-way valve for swimming pool) (*)	The air to water heat pump can be use to heat swimming pool. This output will be ON when swimming pool is activated.
36(L)	Output 2 (Water pump 3 (WP3)) (*)	When there is a hydraulic separator or buffer tank, additional water pump (WP3) is needed.
37	Output 3 (Auxiliary boiler or electric heater) (*)	The boiler can be used to alternate with the heat pump when the heat pump cannot achieve the required temperature by itself.
38		A water electric heater (as accessory) can be used to provide the additional heating required on the coldest days of the year.
39	Output 4 (Solar) (*)	Output for solar combination with Domestic Hot Water Tank.
40		

**NOTE**

(*): Inputs and outputs explained in the table are the factory-set options. By means of the unit controller, some other inputs and outputs functions can be configured and used. Please, refer to the Service Manual for detailed information.

◆ YUTAKI S COMBI

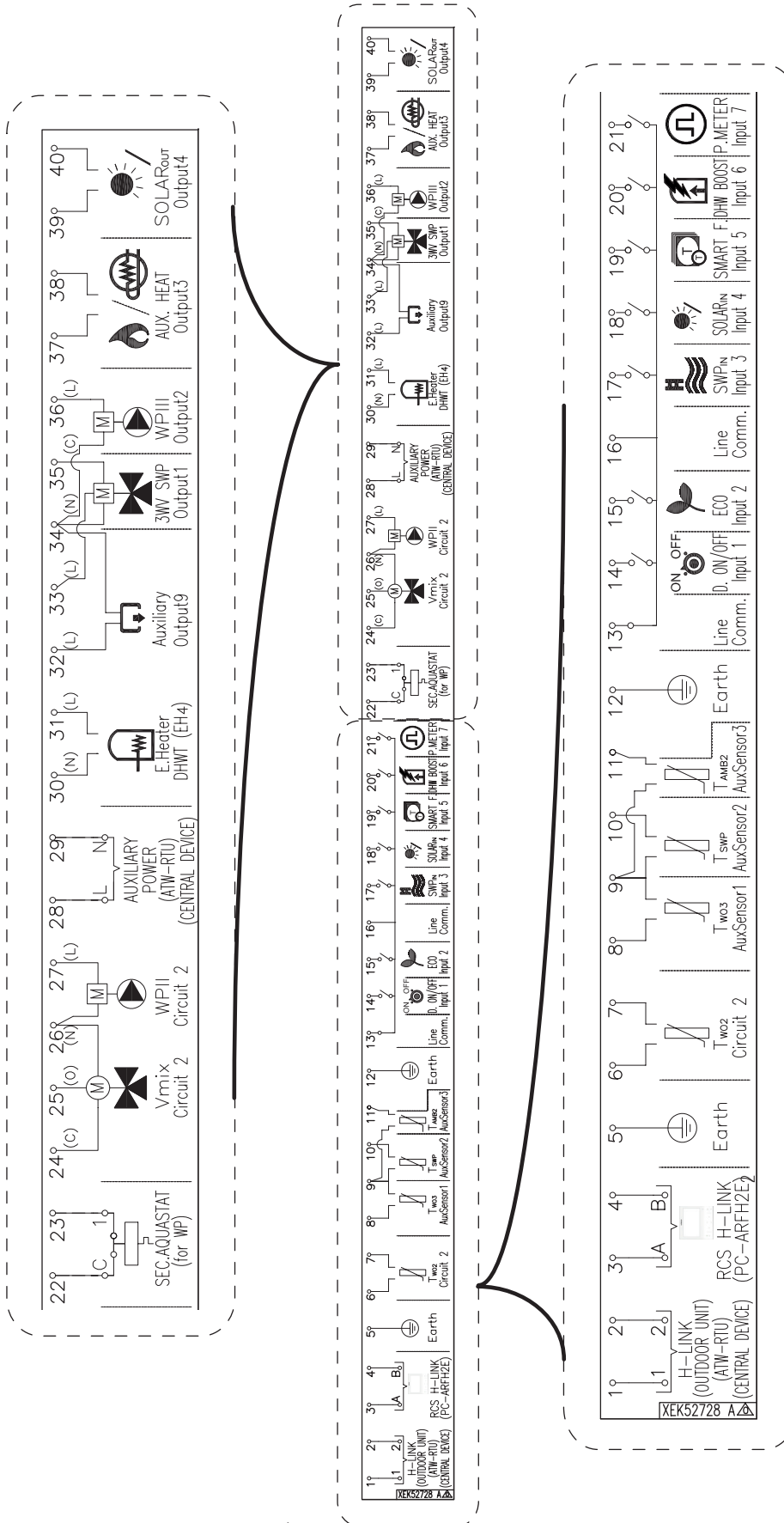

Mark	Part name	Description
TERMINAL BOARD 1 (TB1)		
N	1~ 230V 50Hz 3N~ 400V 50Hz	Main power supply connection
L1		
L2		
L3		
TERMINAL BOARD 2 (TB2)		
1	H-LINK commutation	The H-LINK transmission has to be done between the indoor unit and the terminals 1-2 of either outdoor unit, ATW-RTU or any other central device.
2		
3	H-LINK communication for remote control switch	Terminals for the connection of the YUTAKI unit controller.
4		
5	Earth	Earth connection for the 3 way valve and water pump. NEW
6	Common thermistor	Common terminal for thermistor.
7	Thermistor for water outlet temperature of second cycle	The sensor is used for the second temperature control and should be positioned after the mixing valve and the circulation pump.
8	Thermistor for water outlet temperature after hydraulic separator	Water sensor for hydraulic separator, buffer tank or boiler combination.
9	Common thermistor	Common terminal for thermistors.
10	Thermistor for swimming pool water temperature	The sensor is used for the swimming pool temperature control and should be positioned inside plate heat exchanger of the swimming pool.
11	Thermistor for second ambient temperature	The sensor is used for the second ambient temperature control and it should be positioned outdoors.
12	Earth	Earth connection for the 3 way valve and water pump. NEW
13	Common line	Terminal Line common for input 1 and input 2.
14	Input 1 (Demand ON/OFF) (*)	The air to water heat pump system has been designed to allow the connection of a remote thermostat to effectively control your home's temperature. Depending on the room temperature, the thermostat will turn the split air to water heat pump system ON and OFF.
15	Input 2 (ECO mode) (*)	Available signal which allows to reduce the water setting temperature of circuit 1, circuit 2 or both.
16	Common line	Terminal Line common for inputs 3, 4, 5, 6, 7.
17	Input 3 (Swimming pool) (*)	Only for swimming pool installations: It is necessary to connect an external input to the air to water heat pump to provide signal when the water pump of swimming pool is ON.
18	Input 4 (Solar) (*)	Available input for Solar combination with Domestic Hot Water Tank.
19	Input 5 (Smart function) (*)	For the connection of an external tariff switch device to switch OFF the heat pump during peak electricity demand period. Depending on the setting, the heat pump or DHWT will be blocked when signal is open/closed.
20	Input 6 (DHW boost) (*)	Available input for an instantaneous heating of the domestic hot water of the tank.
21	Input 7 (Power meter)	The measuring of the real power consumption can be done connecting an external power meter. The number of pulses of the power meter is a variable which must be set. By this, every pulse input is added into corresponding operation mode (Heating, Cooling, DHW Operation). Two possible options: - One power meter for all installation (IU+OU). - Two separated power meters (one for IU and one for OU).
22	Aquastat security for circuit 1 (WP1)	Terminals intended for the connection of the Aquastat security accessory (ATW-AQT-01) for controlling water temperature of the circuit 1.
23		
24(C)	Mixing valve close	When a mixing system is required for a second temperature control, these outputs are necessary to control the mixing valve.
25(O)	Mixing valve open	
26(N)	N Common	
27(L)	Water Pump 2 (WP2)	When there is a second temperature application, a secondary pump is the circulating pump for the secondary heating circuit.
28	Auxiliary power	Power supply for ATW-RTU and central device. NEW
29		

Mark	Part name	Description
30(N) 31(L)	Electrical Heater DHW Output	If DHW tank contains an electric heater, the air to water heat pump can activate it if the heat pump cannot achieve the required DHW temperature by itself.
32	Output 9	NEW
33(L)	L common	Power supply for valve accessories NEW
34(N)	N common	Neutral terminal common for outputs 1 , 2 and 9.
35(L)	Output 1 (3-way valve for swimming pool) (*)	The air to water heat pump can be use to heat swimming pool. This output will be ON when swimming pozol is activated.
36(L)	Output 2 (Water pump 3 (WP3)) (*)	When there is a hydraulic separator or buffer tank, additional water pump (WP3) is needed.
37	Output 3 (Auxiliary boiler or electric heater) (*)	The boiler can be used to alternate with the heat pump when the heat pump cannot achieve the required temperature by itself.
38		A water electric heater (as accessory) can be used to provide the additional heating required on the coldest days of the year.
39 40	Output 4 (Solar) (*)	Output for solar combination with Domestic Hot Water Tank.

 **NOTE**

(*): Inputs and outputs explained in the table are the factory-set options. By means of the unit controller, some other inputs and outputs functions can be configured and used. Please, refer to the Service Manual for detailed information.

9.6 Setting of DIP switches and RSW switches

9.6.1 Outdoor unit

9.6.1.1 Location of DIP switches and rotary switches

The PCB in the outdoor unit is operating with DIP switches and push switches. The location is as follows:

RAS-(2/2.5/3)WHVRP1

PCB1

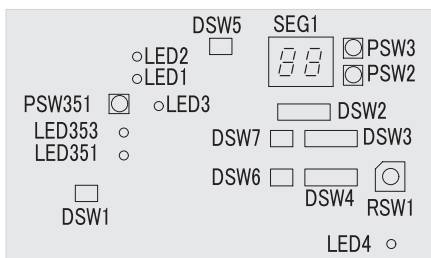

PCB2

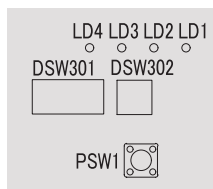

RAS-(4-10)WH(V)NPE

PCB

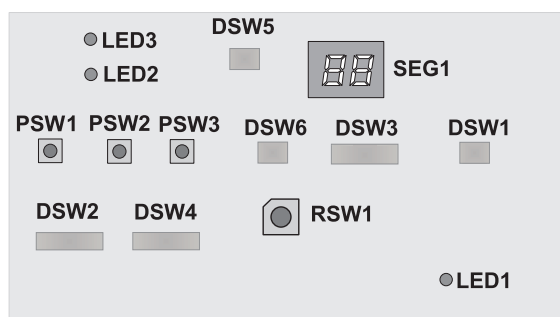

i NOTE

DIP-IPM or PCB2 (depending on model) has a DSW1. When pin number 1 is set to ON position, the electrical current detections is cancelled. Pin number 1 should be to OFF position after electrical work.

9.6.1.2 Function of DIP switches and rotary switches

i NOTE

- The mark “■” indicates the position of dips switches.
- No mark “■” indicates pin position is not affecting.
- The figures show the settings before shipment or after selection.





! DANGER

Before setting dips switches, first turn the power source off and then set the position of the dips switches. In case of setting the switches without turning the power source off, the contents of the setting are invalid.

◆ DSW1 (Only RAS-(2/2.5/3)WHVRP1): No setting is required

<p>When set pin number 1 to ON, the electric current detection is cancelled. Pin number 1 should be set back to OFF after electrical work</p>	
---	--

◆ **DSW1 (RAS-(4-10)WH(V)NPE): For Test run**

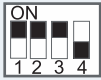
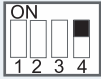



Factory setting	
Test run for pump down	
Test run for heating	
Test run for cooling intermediate season (Not used)	
Test run for heating for intermediate season (Not used)	
Forced stoppage of compressor	





NOTE

- This operation is reset once the compressor is in Thermo-ON mode.
- During the test run operation the units will operate continuously during 2 hours without Thermo-OFF and the 3-minute guard for compressor protection will be effective.
- Test run will start within 20 seconds after setting DSW1 pin 1 to ON position

◆ **DSW301 (Only RAS-(2/2.5/3)WHVRP1): Test run mode**

Setting before shipment	
Test run for pump down	
Test run for heating	
Forced stoppage of compressor	

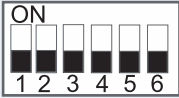
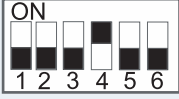
◆ **DSW2: Optional Function setting**

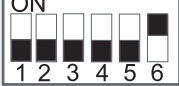
Factory setting	
Control to support existing pipes or when using Ø19.05 gas pipe (soft-annealed), switch ON DSW2 pin 4 in the outdoor unit PCB (for RAS-(4-10)WH(V)NPE)	
Optional function setting mode (The optional function selection mode becomes available)	
External output setting mode (The output signals selection mode becomes available).	

◆ **DSW3: Capacity Setting (No setting is required)**

Outdoor unit Factory setting

RAS-2WHVRP1	RAS-2.5WHVRP1	RAS-3WHVRP1	RAS-4WHVNPE	RAS-5WHVNPE	RAS-6WHVNPE
RAS-4WHNPE	RAS-5WHNPE	RAS-6WHNPE	RAS-8WHNPE	RAS-10WHNPE	

◆ **DSW4 / RSW1: No setting is required (Do not change)**

Setting before shipment		
-------------------------	--	--

◆ **DSW5: End terminal resistance (No setting is required)**

Setting before shipment	
-------------------------	--

◆ **DSW6: No setting is required (Do not change)**

Factory setting (for RAS-(2-3)WHVRP1)	
Factory setting (for RAS-(4-10)WH(V)NPE)	

◆ **DSW7: No setting is required (Do not change)**

Factory setting	
-----------------	--

◆ **DSW302: Piping Length Setting (Only RAS-(2/2.5/3)WHVRP1) (Setting is required)**

Setting before shipment	
Pipe length (<5m)	
Pipe length (≥30m)	

9.6.1.3 LED indication**◆ RAS-(2-3)WHVRP1**

Name	Colour	Indication
PCB1		
LED1	Red	Power
LED2	Green	Communication with inverter
LED3	Yellow	H-Link transmission
LED4	Yellow	Not used
LED351	Red	For inspection
LED353	Red	For inspection
PCB2		
LD1	Red	For inspection
LD2	Red	For inspection
LD3	Red	For inspection
LD4	Red	For inspection

◆ RAS-(4-10)WH(V)NPE

LED Indication		
LED1	Red	This LED indicates the transmission status between the indoor unit and the unit controller
LED2	Yellow	This LED indicates the transmission status between the indoor unit and the outdoor unit
LED3	Green	Power source for the PCB

9.6.2 YUTAKI unit

9.6.2.1 Location of DIP switches and rotary switches

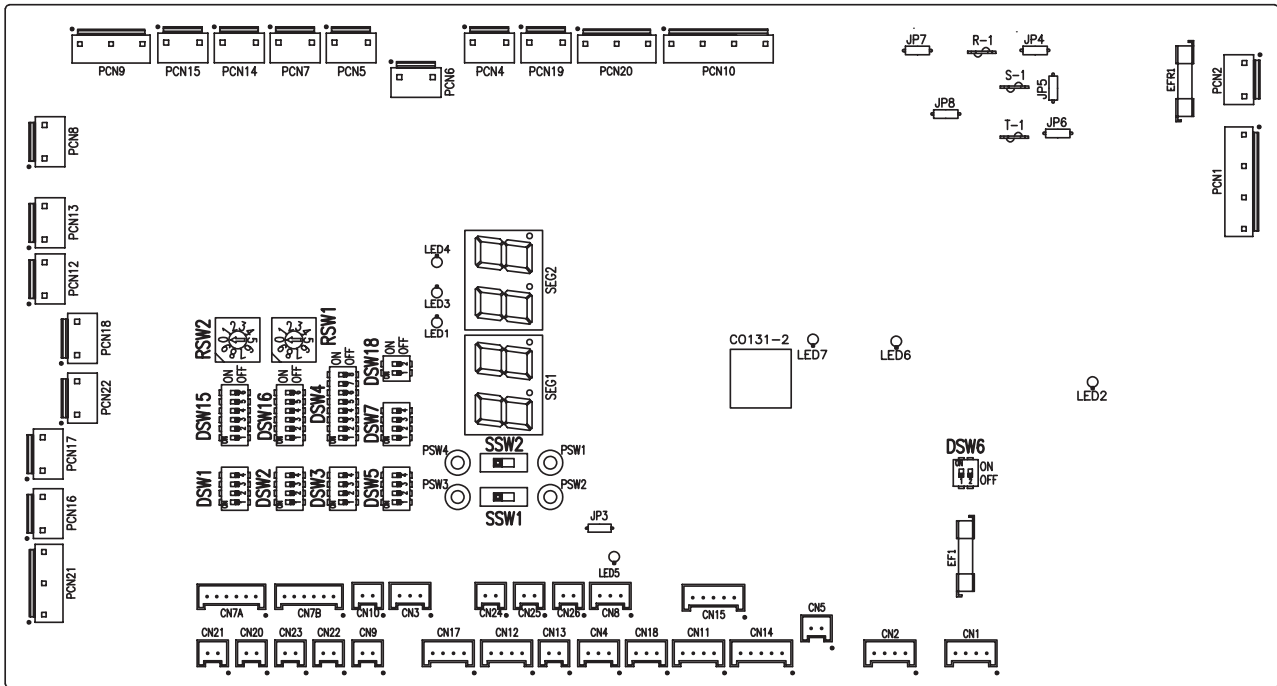

9.6.2.2 Function of DIP switches and rotary switches

i NOTE

- The mark “■” indicates the dip switches positions.
- No mark “■” indicates pin position is not affected.
- The figures show the settings before shipment or after selection.
- “Not used” means that the pin must not be changed. A malfunction might occur if changed.

! CAUTION

Before setting dip switches, first turn the power supply OFF and then set the position of dip switches. If the switches are set without turning the power supply OFF, the contents of the setting are invalid.

◆ **DSW1: Additional setting 0**

Factory setting. No setting is required.

YUTAKI S (*)	
YUTAKI S COMBI (*)	

i **NOTE**

(*): In case of installing the “Cooling kit” accessory, set the pin 4 of DSW1 to ON in order to enable the cooling operation.

◆ **DSW2: Unit capacity setting**

Factory setting. No setting is required.

2.0 HP	2.5 HP	3.0 HP	4.0 HP	5.0 HP	6.0 HP	8.0 HP	10.0 HP

◆ **DSW3: Additional setting 1**

Setting before shipment	
1-step heater for 3-phase unit	

◆ **DSW4: Additional setting 2**

Setting before shipment	
DHW defrost	
Heater forced OFF	
Unit and installation pipes antifreeze protection	
Standard / ECO water pump operation	

Electric heater or boiler emergency mode	
DHW tank's heater operation	
DHW 3-way valve forced ON (All models)	

⚠ CAUTION

- Never turn all DSW4 dip switch pins ON. If this happens, the software of the unit will be removed.
- Never activate “Heater Forced OFF” and “Electric heater or boiler emergency mode” at the same time.

◆ **DSW5: Additional setting 3**

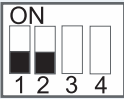
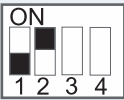
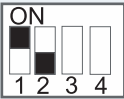
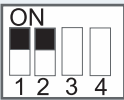
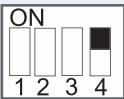

In the cases where the outdoor unit is installed into a location where its own outdoor ambient temperature sensor can not give a suitable temperature measurement to the system, it is available the 2nd outdoor ambient temperature sensor as accessory. By means of DSW1&2 setting, the preferable sensor for each circuit can be selected.

Factory setting	
Outdoor unit sensor for circuits 1 and 2	
Outdoor unit sensor for circuit 1; Auxiliary sensor for circuit 2	
Auxiliary sensor for circuit 1; Outdoor unit sensor for circuit 2	
Auxiliary sensor instead of outdoor unit sensor for both circuits	
Use the maximum temperature value between T_{wo3} (boiler / heater thermistor) and T_{wo} (water outlet thermistor) for water control	



◆ **DSW6: Not used**

Factory setting (Do not change)	
------------------------------------	---

◆ **DSW7: Additional setting 4**

Factory setting	
Compatibility with ATW-RTU-04 (When cooling mode operation is needed)	

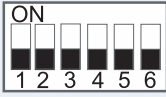
◆ **DSW15 & RSW2 / DSW16 & RSW1: Not used**

	DSW16	RSW1
Factory setting		



i NOTE

Don't change this setting, otherwise malfunction will be occur.





◆ **DSW18: Not used (only for YUTAKI S COMBI)**

Factory setting (Do not change)	
------------------------------------	---

◆ **SSW1: Remote/Local**

Factory setting	Remote	
Remote operation	Local	
Local operation	Remote	
	Local	

◆ **SSW2: Heat/Cool (when SSW1 is in local setting)**

Factory setting	Heat	
Heat operation	Cool	
Cooling operation (when cooling kit installed)	Heat	
	Cool	

9.6.2.3 LED indication

Name	Colour	Indication
LED1	Green	Power indication
LED2	Red	Power indication
LED3	Red	Heat pump operation (thermo ON/OFF)
LED4	Yellow	Alarm (flickering with 1 sec interval)
LED5	Green	Not used
LED6	Yellow	H-Link transmission
LED7	Yellow	H-Link transmission for unit controller

10 . LCD Controller

Index

10.1	General information.....	142
10.2	Display.....	142
10.2.1	Main view	142
10.2.2	Dual view.....	143
10.2.3	Menu display	143
10.3	New features	144
10.3.1	Live view.....	144
10.3.2	Operational data list	145
10.3.3	Lock controller.....	145
10.3.4	Communication status menu.....	145
10.3.5	Serial number	146
10.3.6	Alarm description.....	146
10.3.7	Alarm history.....	146
10.3.8	Pump down procedure	146
10.3.9	DHW tank position.....	147
10.3.10	Water pump operation.....	147
10.3.11	Electrical Heater limitation	147
10.3.12	Energy consumption data.....	148
10.3.13	Wizard start up	148
10.3.14	Fan coils control	149
10.3.15	Wizard to timer set	151
10.3.16	Weekly timer.....	152
10.3.17	Override function.....	152
10.3.18	Display theme.....	152

10.1 General information

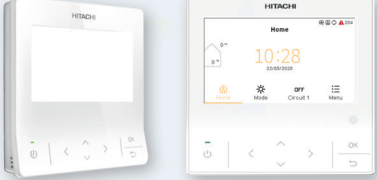
Model	Available languages	Information	Figure
PC-ARFH2E	26 languages: EN, FR, ES, DE, IT, NL, SL, DA, SV, FI, PT, HR, EL, PL, UK, HU, RO, SK, CS, TR, BG, LT, RU, ET, LV, SR	This unit controller can be detached from the indoor unit and used as both: unit controller and wired room thermostat. Exclusive for YUTAKI RWM-(2.0-10.0)(N/R)1E and RWD-(2.0-6.0)(N/R)W1E-220S(-K) units	

10.2 Display

10.2.1 Main view

The device is composed by a bottom tab widget to move around the different views.

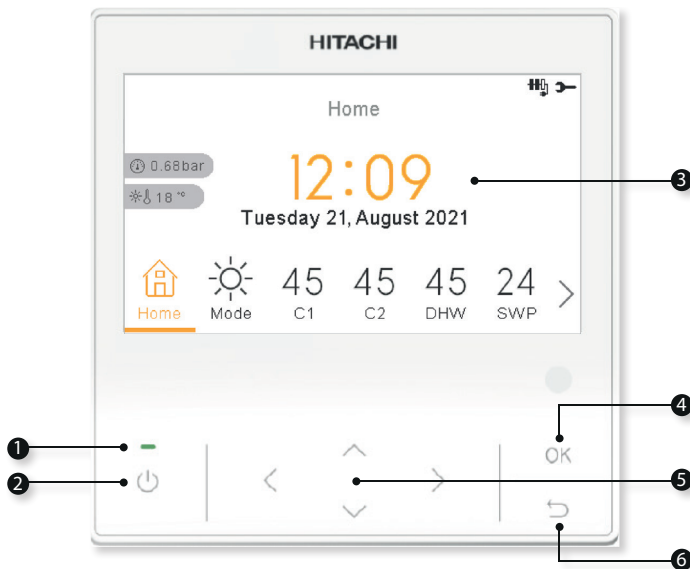

N°	Description
1	Run / Stop
2	LED status indicator
3	Liquid Crystal Display
4	OK button
5	Arrow keys
6	Return

Featuring a new screen layout and new icons.

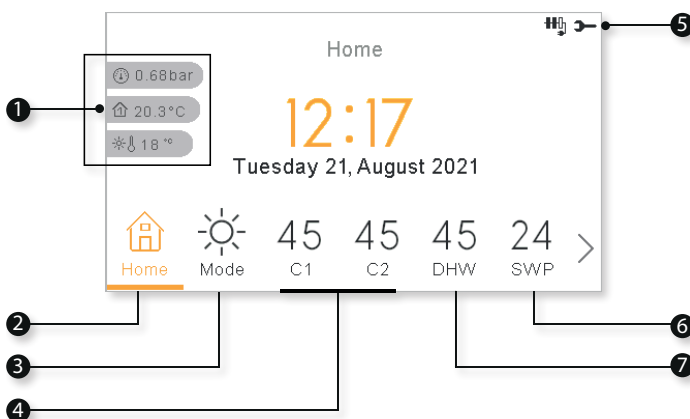

N°	Description
1	Water pressure, room temperature and outdoor temperature indicators
2	Home view
3	Mode selection (Heating / Cooling / Auto)
4	Circuit 1 or 2 status
5	General icons about unit operations (Alarm, timer, compressor, defrost, etc)
6	Domestic Hot Water status
7	Swimming Pool status

NOTE

With the swimming pool mode activated, SWP status is displayed.

10.2.2 Dual view

This new unit controller can be used as a wired room thermostat.

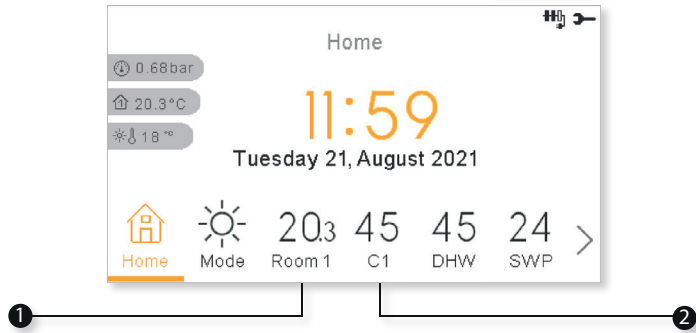

N°	Description
1	Setting temperatures
2	Circuit temperatures

10.2.3 Menu display

Same current menu structure, with a more intuitive display and some improvement on the menus.

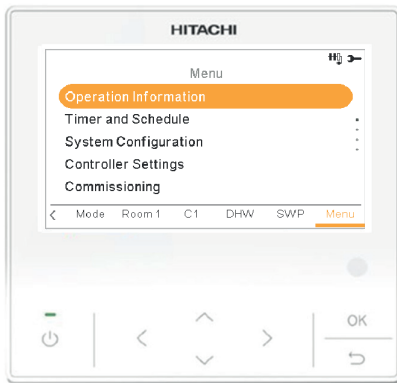

Colour display inside menu

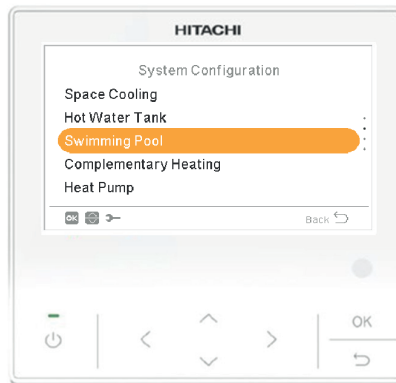

New scrolling indication

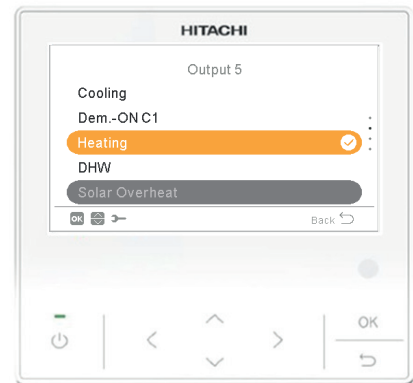

New indication (colour + tick) showing you can revise the setting. Grey line equals option disabled

10.3 New features

A new set of features that increase installer support on the field to check system operation and improve the customer experience.

10.3.1 Live view

Live view is a summary of system status information shown on operation information. Data available depends on system and usage (Heating, Cooling, Heater, etc).

Refrigerant cycle

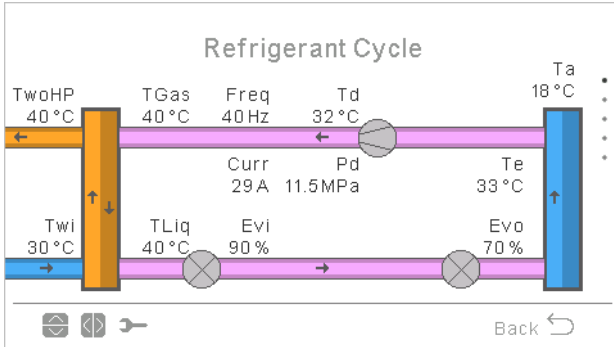

Water generation

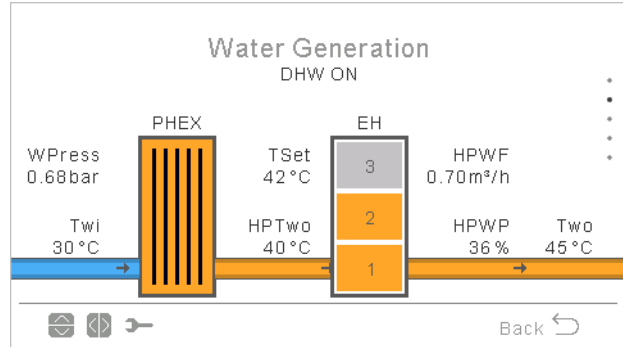

Circuit 1

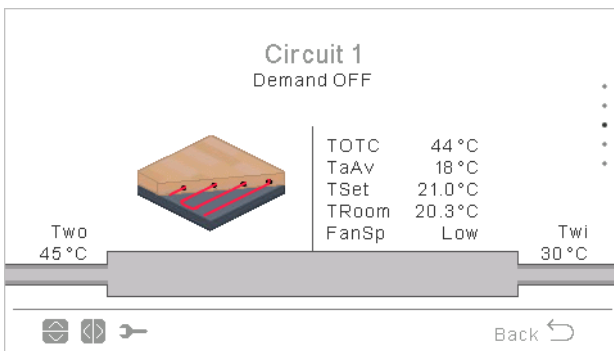

Circuit 2

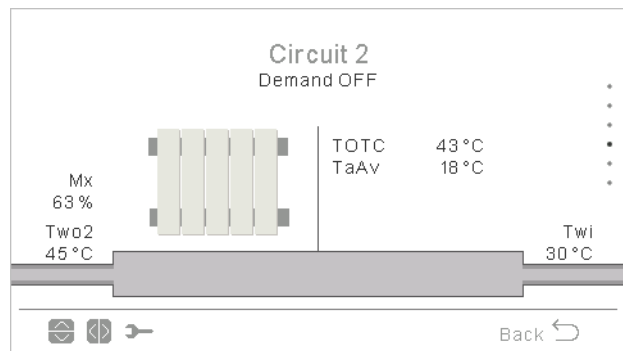

Hot Water Tank

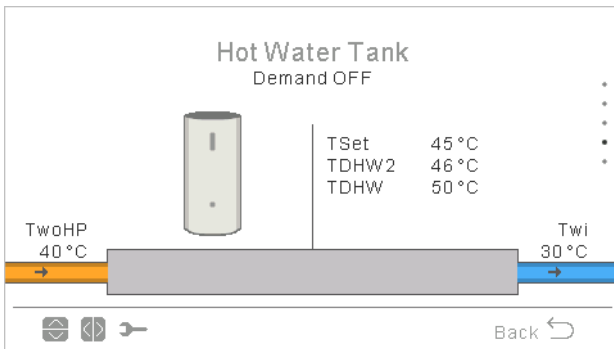

Swimming pool

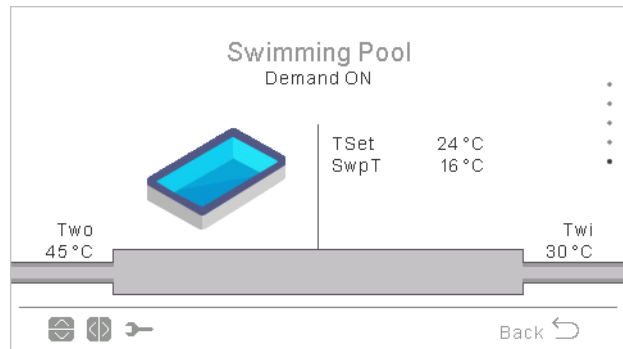

10.3.2 Operational data list

Recent Status Register is an historical data that displays the main variables during the last hours. Specifically 23 parameters are recorded every 5 min and available on the LCD controller for the 2 last running hours. Data resets when the unit is powered off.

Recent Status Register				
⌵	OPST	HPTi	HPTo	TwoHP
09:35	🔥	30 °C	45 °C	40 °C
09:30	🔥	30 °C	45 °C	40 °C
09:25	🔥	30 °C	45 °C	40 °C
09:20	🔥	30 °C	45 °C	40 °C
09:15	🔥	30 °C	45 °C	40 °C

10.3.3 Lock controller

This function is only visible for the installer and allows to lock the menu in case of exhibition. This action can also be launched from central.

Menu 🔑

- Controller Settings
- Commissioning
- About
- Lock the Controller
- Factory Reset

< Room 1 Fan 1 C1 DHW SWP Menu

Installer Access

Enter Password

🔑 < > Back ↩

10.3.4 Communication status menu

Detailed information about Communication status for H-Link, H-Link Central, RCS Central and CASCADE CONTROLLER.

Communication Status

H-Link
Working

🔑 < > Back ↩

10.3.5 Serial number

IDU serial number of installation units in system information menu.

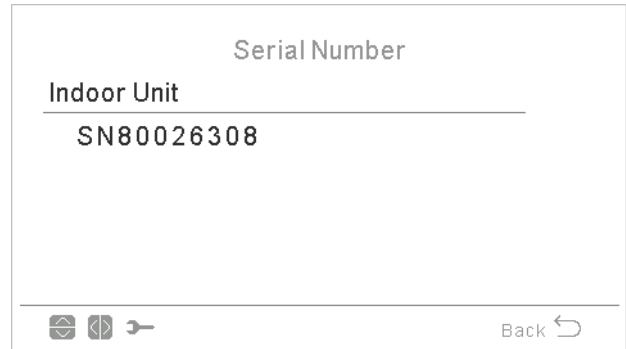
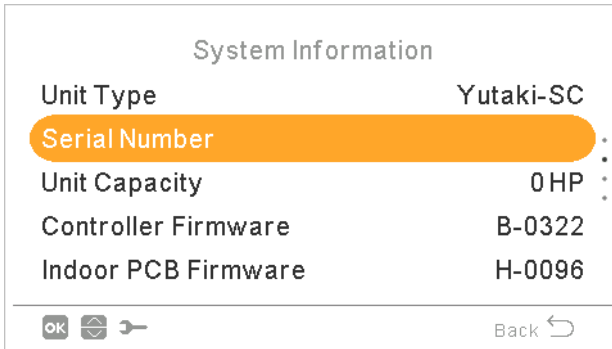

10.3.6 Alarm description

Short description down to each alarm code.

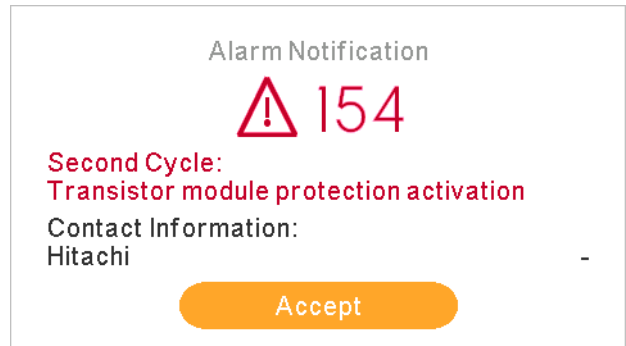
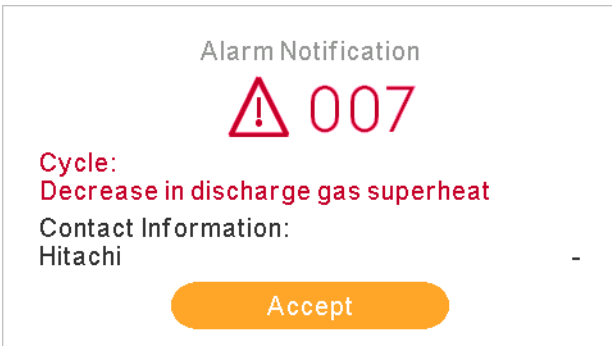

10.3.7 Alarm history

Shows a list of the alarm history of the system.



10.3.8 Pump down procedure

Pump Down Procedure configuration in the commissioning menu.

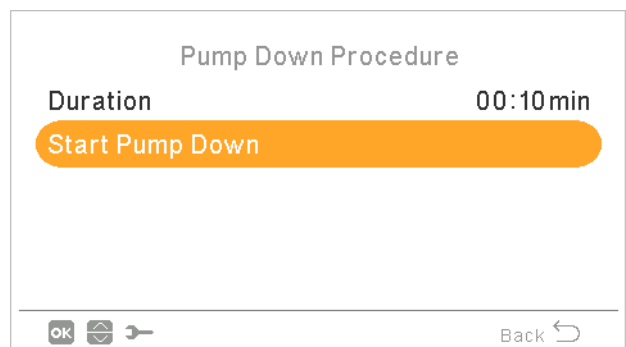
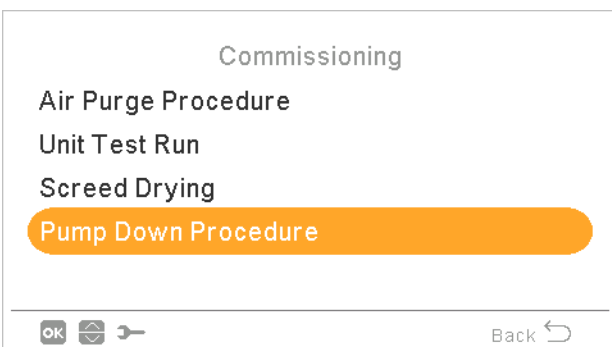

10.3.9 DHW tank position

Configuration of the Domestic Hot Water tank position before or after the hydraulic separator.

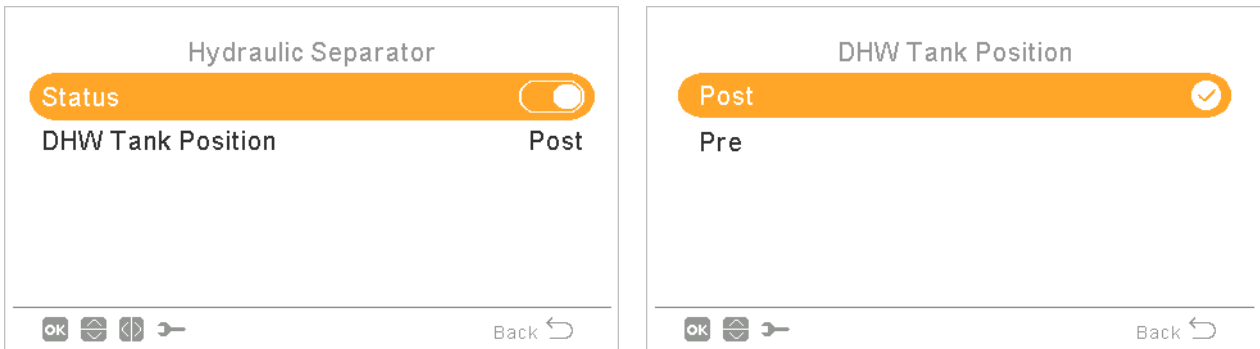

10.3.10 Water pump operation

Enable / Disable water pumps for space heating during Domestic Hot Water operation.

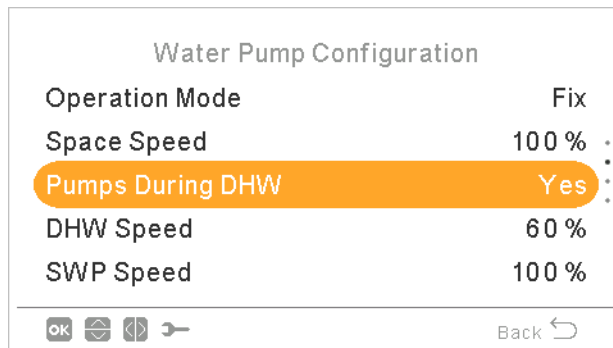

10.3.11 Electrical Heater limitation

Maximum heater step configuration (only in cas of backup option).

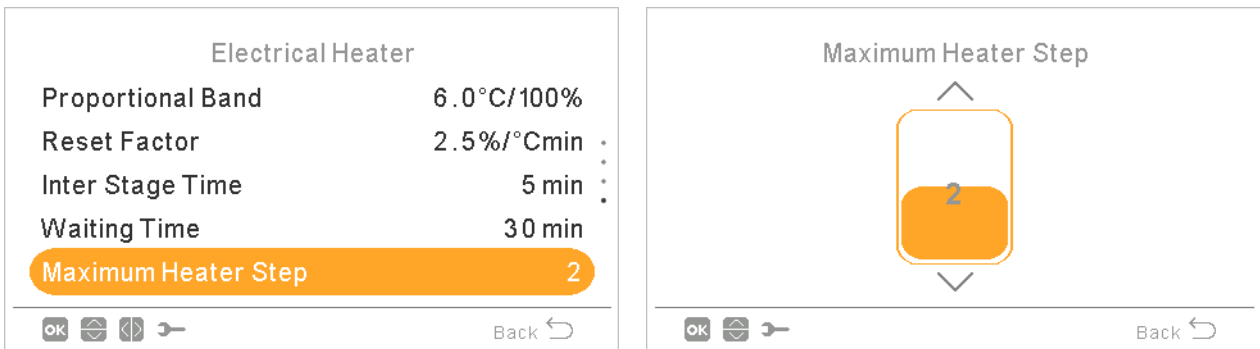

10.3.12 Energy consumption data

Consumption information can be switched between Total / Space heating / Space cooling / DHW / SWP, with a comparison between Months / Weeks / Days. Without power meter installed the controller shows an estimation of outdoor unit and indoor unit consumption. With the power meter installed pulses information are automatically available into the controller, which allows a live reading of the consumption.

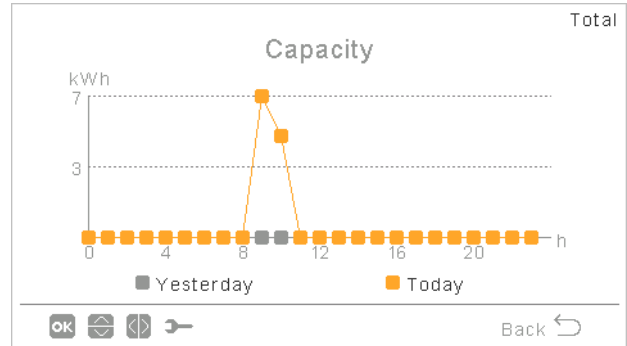
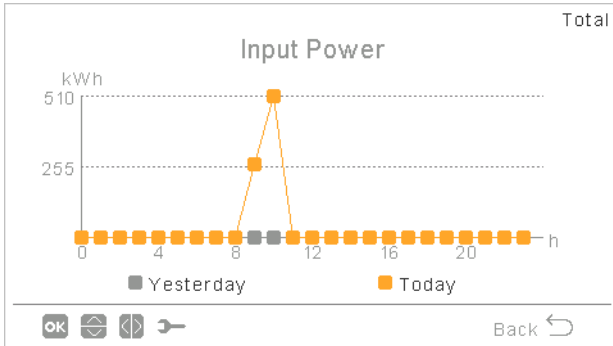

10.3.13 Wizard start up

When the controller is initiated from factory default, it shows up the wizard configuration start up.

What are the heat emitters installed on circuit 1?

Underfloor Heating

Fan Coils

Radiators

The Configuration Assistant asks 4 questions to declare the emitters for each Circuit and mode.

Do you have a boiler installed?

No

Yes, connected in parallel

Yes, connected in serial

Boiler installation definition: Parallel / Serial.

Do you want to control the fan coil of circuit 1 through the outputs?

No

Yes

When selecting a fan coil as emitter, Configuration Assistant ask whether it must be controller from YUTAKI's output.

10.3.14 Fan coils control

◆ Selecting fan speed outputs

Main controller allow to configure 2 different emitters (emitter for heating and emitter for cooling) within same circuit. So, as an example, Circuit 1 can be configured with radiators for Heating and fan coils for Cooling while Circuit 2 can be configured only with fan coils for both modes.

When one circuit has fan coils as an emitter, YUTAKI unit allows to manage 3 speed of the fan coil (Low / Med / High) directly from each room controller and use YUTAKI outputs to send a 230V signal to each motor fan speed. It is possible to independently manage 3 speeds of 2 different fan coils located at Circuit 1 and Circuit 2.

Since YUTAKI S has 4 outputs as standard and YUTAKI S COMBI has 5 outputs as standard, it may be necessary to use external accessory ATW-AOS-02 to reach up to 8 outputs for YUTAKI S and up to 9 outputs in case of YUTAKI S COMBI. Output configuration for the 3 speeds of each fan coil is done using the unit controller.

The screenshots show the following menu structure:

- System Configuration**
 - Heat Pump
 - Fan Coils
 - Optional Functions
 - I/O and Sensor** (selected)
 - Holiday Mode
- I/O and Sensor**
 - Standard Outputs** (selected)
 - Optional Outputs
 - Auxiliary Sensors
- Standard Outputs**

Output 1	Deactivated
Output 2	Fan 1 Low
Output 3	Fan 1 Medium
Output 4	Fan 1 High
Output 9	Deactivated
- Optional Outputs**

Output 5	Fan 2 Low
Output 6	Fan 2 Medium
Output 7	Fan 2 High
Output 8	Deactivated

◆ Fan speed control

Fan AUTO mode can be selected as well. High, Medium or Low fan speed will be decided according to the temperature difference between the room setting temperature and real ambient temperature.

The LCD display shows the following information:

- Fan 1** (with a fan icon and 'A' for Auto)
- Auto** (mode)
- Mode**: Sun icon
- Room 1**: 20.3
- Fan 1**: Fan icon with 'A'
- C1**: 45
- DHW**: 45
- Menu**: List icon

◆ **Control options**

Controlled Fan Zones

The fan-coil use for every circuit can be readjusted. Using the Controlled Fan Zones menu is possible to change the initial fan coil declaration at any moment to adapt YUTAKI control to the existing fan coil installation (Disabled / Heating / Cooling / Heating and Cooling).

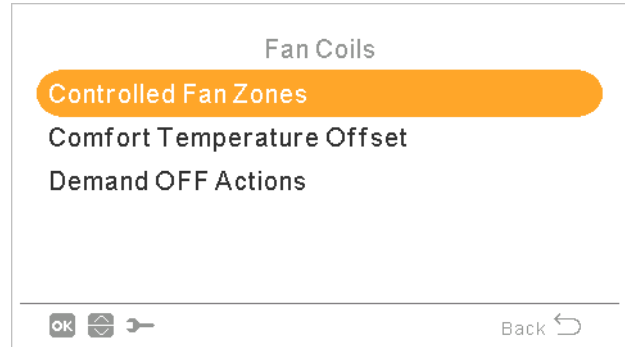
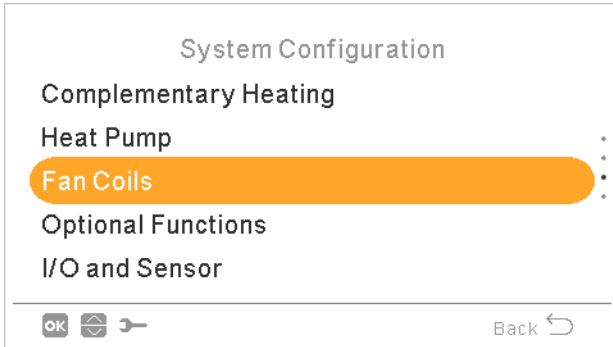

Comfort temperature offset

During the starting of the system, room Demand-off or defrost water temperature may not be high enough to provide a comfortable heating: blowing air at cold or even ambient temperature will cause discomfort. This function allow to define a water temperature offset below the set-point target in order to stop fan operation. Thanks to this, the cold draft that may be caused during start-up or defrost is avoided. Fan 1 and Fan 2 can be set with a different offset value. Circuit 1 is controlled by T_{wo} and Circuit 2 by T_{wo2} sensors. It does not apply for Cooling mode.

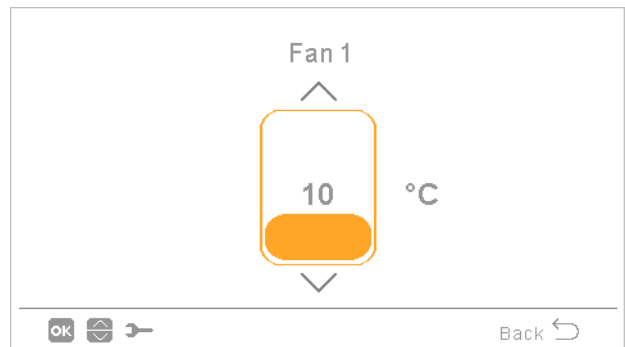
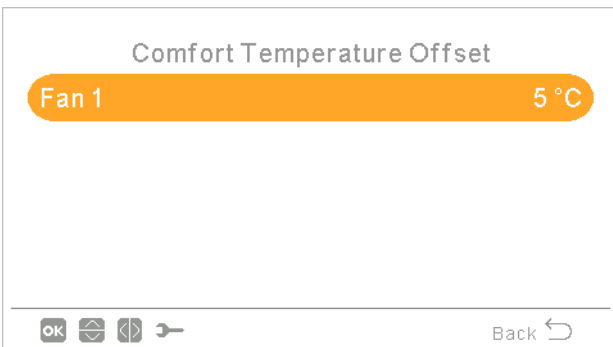

Demand Off Actions

There are 2 conditions where Room 1 and 2 may be switched to Demand OFF: Room temperature is satisfied, Heating / Cooling is not required at that moment or DHW operation is requested. Discomfort may happen sometimes during Demand OFF.

Demand OFF Actions menu is allowing to select if the Fan must stop or not for every Room and mode Heating / Cooling individually.

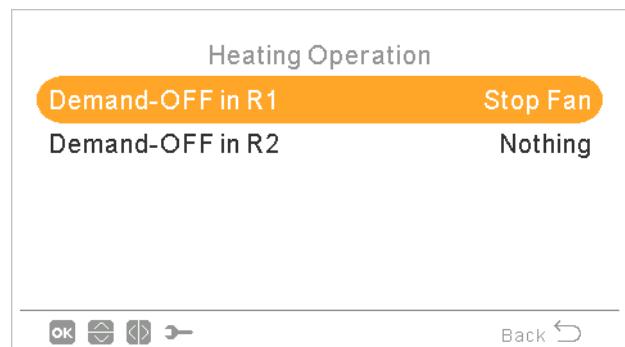
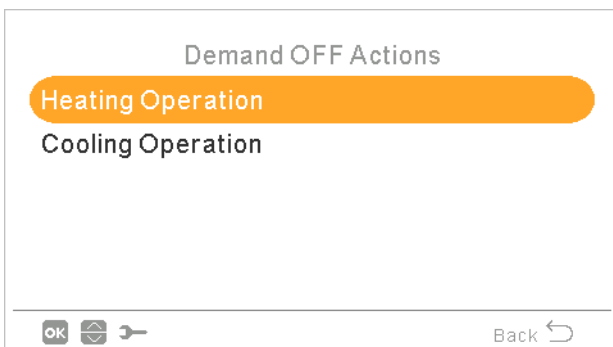

Constant Heating / Cooling Output

Additionally it can be configured Constant Heat / Constant Cool output. Constant Heating output remains in high state when YUTAKI LCD is in Heating mode (regardless Defrost, Thermo ON / OFF or Demand ON / OFF). Constant Cooling output remains in high state when YUTAKI LCD is in Cooling mode (regardless Thermo ON / OFF or Demand ON / OFF).

The purpose of this output is to control a 3 way valve able to drive water to different emitters depending on the LCD operation mode. For example, water is sent to radiant floor in winter and to fan coils in summer. Heating or constant cooling signal will depend on the default position of the 3-way valve.

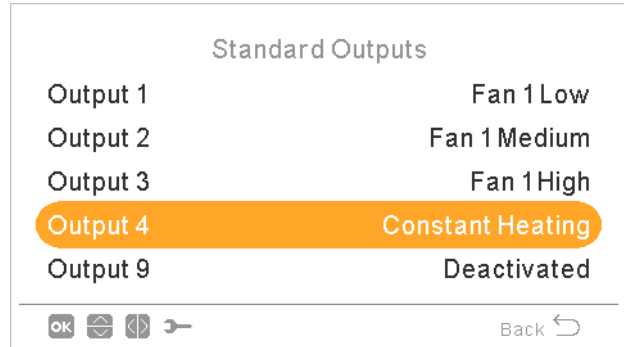
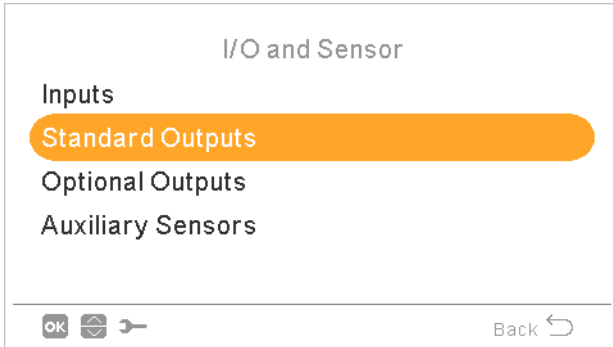

Additional considerations

YUTAKI software is based on 3-speed fan-coil output control and cannot be changed. In the eventual case that less than 3 speed are required, the fan coil wiring must be arranged so the 3 outputs are linked with the requested speed. When the Room Thermostat is switched off the fan coil is stopped as well. Fan only operation is available when selecting Circuit OFF and Fan ON.

10.3.15 Wizard to timer set

It is possible to set the timer for Room thermostats with a timer assistant. Consists of 3 questions to help customer to set a weekly timer. 4 patterns per mode (Heating / Cooling) are defined . Schedule is automatically planned according to the answers.

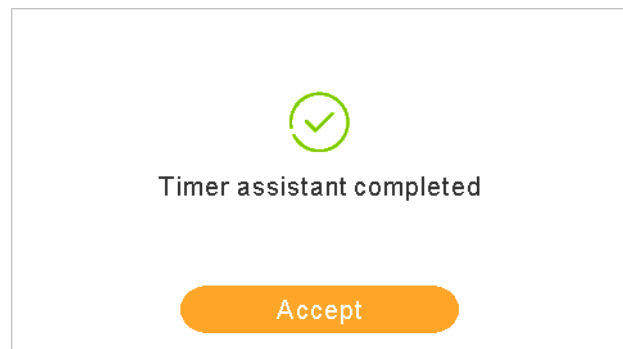
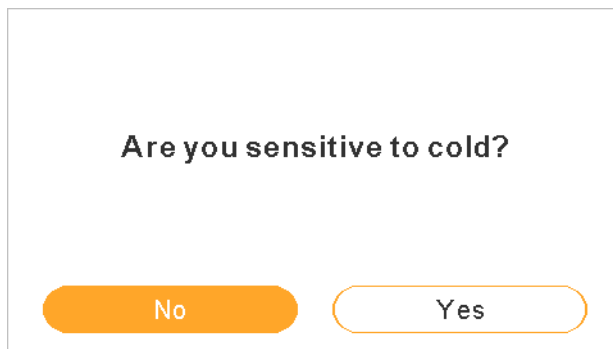
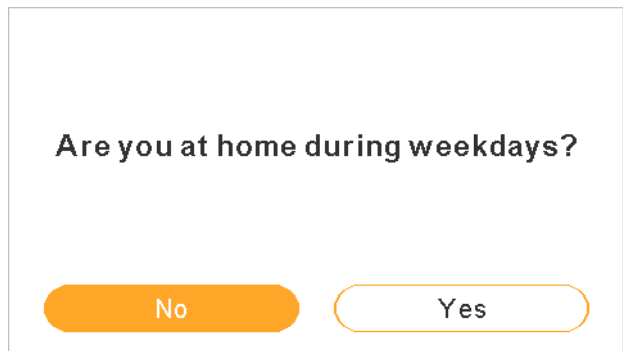
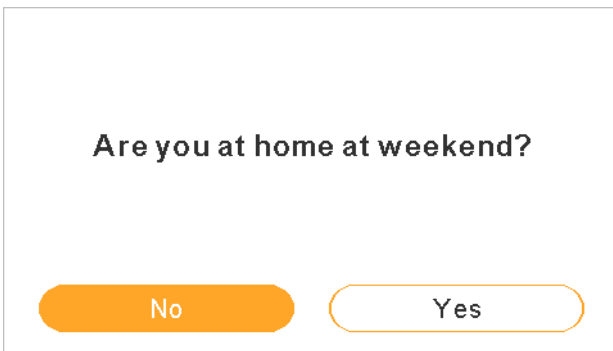

10.3.16 Weekly timer

Allows to change the operation mode (ECO or Comfort) or change of operation state from ON to OFF for a defined period, after which operation returns to the previous settings. Manual operation of the unit controller has priority over schedule settings.

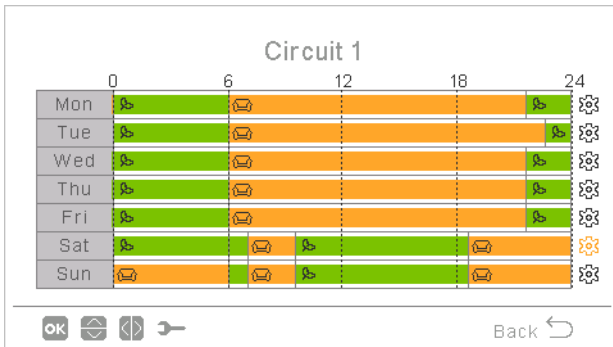

Monday

From	To	Status	Mode
00:00	06:00	On	Eco
06:00	21:30	On	Comfort
21:30	(06:00)	On	Eco
-	-	-	-

10.3.17 Override function

When a different configuration from the defined by the timer of a zone is done, it is possible to override the timer configuration during a specific time.

Override Configuration

Type Until Next Action

Type

Until Next Action

Specific Time

Forever

10.3.18 Display theme

Display Theme

Light

Dark

Auto

An automatic display mode can be set to switch between normal and dark mode according to a schedule.





11 . Optional functions







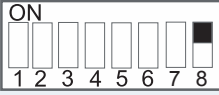
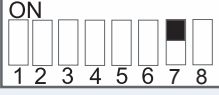
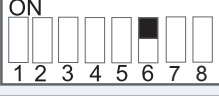

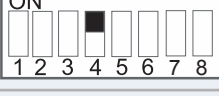
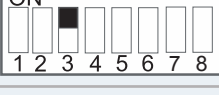
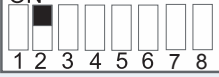
Index

11.1	Indoor unit	154
11.1.1	Optional functions by DSW setting	154
11.1.2	Optional functions by Unit controller (PC-ARFH2E)	156
11.1.3	Optional external input/output configuration signals	158
11.2	Additional functions by accessory sensor	161
11.3	Change of defrost condition	162
11.4	Output/input signals for outdoor units.....	163

11.1 Indoor unit

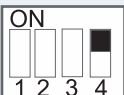
11.1.1 Optional functions by DSW setting

Code	Optional function description	Explanation
DSW1#4:ON 	Heating & Cooling (ON) Unit	In case of cooling operation, this DSW should be set to ON + Cooling kit accessory.
DSW3#3:ON 	1 step heater for 3 phase unit option	This option can be used to switch all 3 steps of the electric heater at the same time, by means of a DIP-switch setting, in order to prevent 3-phase imbalance by the electric heater steps.
DSW4#8:ON 	DHW Defrost	This function allows to perform the defrost operation at the DHW tank instead of at the indoor water installation.
DSW4#7:ON 	Heating Heater forced OFF	This function forces a permanent OFF of the heater when selecting an installation configuration without the electric heater of the unit.
DSW4#6:ON 	Unit and pipes installation freeze protection	This function allows to start water pump in very low water temperature conditions to avoid freezing.
DSW4#5:ON 	Standard / Economic water pump operation	This function allows to select conditions to stop pumps when not required. Purpose of economic mode is to reduce pump operation when there is no need of Heating/Cooling operation. In case Standard is selected, pumps are only stopped when Circuits are in OFF state.
DSW4#4:ON 	Emergency Heater operation manual option	In the event of outdoor unit failure, the required heating can be provided by an electric heater or by a boiler.
DSW4#3:ON 	DHW Heater Operation	The electric heater of the domestic hot water tank is disabled by factory setting. This function allows to activate its operation if needed.
DSW4#2:ON 	DHW 3 way valve forced ON	Activation of this DSW forces Unit to stop in order to open expansion valves. This can be useful for refrigerant recovery with an external equipment. At the same time, DHW 3WV is forced to commute to tank position. This can be used, for example for a quick water filling of the DHW tank's heating coil.

Code	Optional function description	Explanation
DSW5#1:OFF;2#OFF 	C1 : Average OU Sensor C2 : Average OU Sensor	A 2nd outdoor ambient temperature sensor is available as an accessory, in case that the built-in ambient temperature sensor of the outdoor unit cannot provide a reliable temperature measurement to the system because of restraints of the installation location. The preferred sensor for each circuit can be selected by means of DSW setting.
DSW5#1:OFF;2#ON 	C1 : Average OU Sensor C2 : Average Aux Sensor	
DSW5#1:ON;2#OFF 	C1 : Average Aux Sensor C2 : Average OU Sensor	
DSW5#1:ON;2#ON 	C1 : Average Aux Sensor C2 : Average Aux Sensor	
DSW5#4:ON 	Use max (T_{wo}/T_{wo3}) for water control	
SSW1 Remote  Local 	Remote or Local operation (Manual)	Refer to Service Manual.
SSW2 Heat  Cool 	Cool and Heat operation in case of Local (Manual)	Refer to Service Manual.

11.1.2 Optional functions by Unit controller (PC-ARFH2E)

11.1.2.1 Optional functions for Space Heating or Space Cooling

Optional function	Explanation
Floor screed drying function (Circuits 1 & 2)	This function is used exclusively for the process of drying screed that has been newly applied to floor heating system. The water temperature set-point follows a predetermined schedule upon activation of the floor screed drying function. For more information refer to Water control chapter
Heating Auto ON/OFF	At higher outside temperatures it doesn't make sense to keep heating the building. The YUTAKI S System will switch the heating off when the daily average outdoor temperature of previously day rises above the Summer Switch Auto On/Off Activation Temperature. For more information refer to Service Manual.
Auto Heat-Cool	Only available for Cooling and Heating models and cooling mode enabled. By using auto summer switch off average, user can use auto heat cool mode. The end-user sets the desired operation mode on the user interface: Heating, Cooling or Automatic. When Automatic is selected, the change of the operation mode is based on: Averaged outdoor temperature: the operation mode will be changed in order to always be within range determined by the space heating OFF temperature for heating and the space cooling ON temperature for cooling. If the outdoor temperature drops, the operation mode switches to heating and vice versa. For more information refer to "Service Manual.
Outdoor temperature average timer	The average timer corrects the influence of ambient temperature variations. The weather-dependent set point calculation is done on the average outdoor temperature. The outdoor temperature is averaged over the selected time period. For more information refer to Service Manual.

11.1.2.2 Optional functions for DHW

Optional function	Explanation
DHW anti-Legionella protection	A specific setting is available to protect the DHW system against Legionella, which raises up the DHW temperature over the normal DHW tank temperature setting (using the electric heater of the DHW tank and/or the heat pump) on a periodic basis. For more information refer to Service Manual.
DHW re-circulation	This function allows the activation of the water pump for the re-circulation of the hot water from the DHW tank by means of the heat pump. This function can also be used with the anti-legionella protection function. For more information refer to Service Manual.
DHW boost	With this function enabled, it is possible to request a heating up of the DHW when user requires an instantaneous delivery of DHW. For more information refer to Service Manual.
DHW Mode	DHW operation has 3 different modes, ECONOMIC (only for SC units), STANDARD and HIGH DEMAND : <ul style="list-style-type: none"> ECONOMIC Mode: The heating of the domestic hot water shall be started when water temperature in tank is low enough for Heat Pump to be started measured with the top most tank thermistor. DHW is always started heated by Heat Pump. Usage of this mode, it is reduced the amount of heating up procedures. STANDARD Mode: Behaves the same as Economic mode but it is used the lowest tank sensor to judge water temperature inside tank. This functionality ensure higher quantity of water already heated inside of tank and heating-up process are more frequent. HIGH DEMAND Mode: The heating of the domestic hot water is started if differential is bigger than T_{DHWON}. It will be started with water tank heater only unless water temperature in tank goes below Heat Pump starting temperature measured with the lowest sensor on tank. For more information refer to Service Manual. In case of YUTAKI S, it is only possible selection of Standard and High Demand modes.

11.1.2.3 Optional functions for Heat pump

Optional function	Explanation
Hydraulic separator combination	<p>In some cases, water pump of the YUTAKI unit is not sized for big heating installation (small water pump). In this case, a hydraulic separator or buffer tank and secondary water pump has to be used to ensure proper water pump dimensioning.</p> <p>The boiler is configured in parallel with the heat pump. A hydraulic separator or buffer tank has to be used to ensure proper hydraulic balancing. Additional Water pump (WP3) and water sensor (T_{wo3}) are needed for boiler combination control (automatic added when Boiler combination is enabled).</p> <p>For more information refer to Service Manual.</p>
Pumps setup	<p>This option allows to configure between 2 hydraulic schemes when hydraulic separator is used. Standard configuration forces WP3 to operate whenever there is demand from Circuit 2. On the other hand, Parallel configuration, allows to connect WP3 and WP2 to the buffer tank, and operation of WP3 is independent to the operation of WP2.</p> <p>For more information refer to Service Manual.</p>
DHW tank location selection (only for YUTAKI S)	<p>Whenever there is buffer tank or hydraulic separator, user can select position of DHW external tank with respect to the hydraulic separator. This means that it is possible to place 3WV and DHW tank before or after the hydraulic separator. In case 3WV valve and DHW tank is placed before buffer tank, it is not required to heat the whole buffer tank up to the coils temperature whenever DHW operation is performed.</p>
Electrical heater or boiler emergency mode	<p>For the use of the electrical heater or boiler in case of outdoor unit fault, additional setting shall be applied into IU setting:</p> <p>Electrical heater emergency can be both automatic or manual switched ON by the user and the configuration must be done from the Unit controller</p> <p>For more information refer to Service Manual.</p>
System consumption data control	<p>YUTAKI unit performs an estimation of the system consumption. For a real power consumption measure, it is necessary to connect an external power meter.</p> <ul style="list-style-type: none"> No power meter connected: The estimation of the system consumption includes ODU unit, pumps, heaters and electronics. Such consumption estimation is showed on Unit controller. Since it is an estimation, consumption may differ from real measurements by means external power meter. Power meter connected: The number of pulses of the power meter is a variable which must be set through the unit controller. By this, every pulse input is added into its corresponding operation mode (Heating, Cooling, DHW Operation). Two possible options: <ul style="list-style-type: none"> - One power meter for all installation (IU+OU). - Two separated power meters (one for IU and one for OU). <p>For more information refer to Service Manual.</p>
Capacity data control	<p>Due to usage of Water temperature inlet and outlet + water flow leve, a estimation of capacity can be checked.</p> <p>This screens show the value of kWh for each zone (Heating,Cooling, DHW, swimming pool and its total) and also let to see the values month by month.</p> <p>For more information refer to Service Manual.</p>
Smart Grid ready	<p>This function can be used to block or limit the heat pump or increase demand due to electricity availability. Demand increase is configurable for heating and also for cooling operation.</p> <p>For more information refer to Service Manual.</p>
Air Purge	<p>Air purge function drives the pump in a way for evacuating air bubbles in the installation.</p> <p>For more information refer to Service Manual.</p>
Unit Test Run	<p>Test run is a working mode used when commissioning the installation. Some settings are made to let the installer an easy job.</p> <p>For more information refer to Service Manual.</p>
Night shift	<p>Night shift operation reduce compressor load in order to reduce environmental noise during night.</p> <p>It can be configured as a daily timer or launched from favourite button.</p> <p>For more information refer to Service Manual.</p>
Fan coil management	<p>In case fan coil is selected as a Heating/cooling emitter, fan speeds can be controlled from Room thermostat and fan coil's fan speeds are controlled from YUTAKI optional outputs</p>
Pump down operation	<p>By performing a pump down operation compressor starts in cooling mode regardless no configuration for cooling has been made with the purpose to collect refrigerant at the ODU unit.</p>

11.1.2.4 Optional functions for Unit controller (PC-ARFH2E)

Optional function	Explanation
UTC Zone	UTC Zone: Europe spans 7 primary time zones (5 of them can be seen on the map in this article, while 2 other zones contain the European part of Kazakhstan and some very eastern territories of European Russia). Most of European countries use daylight saving time and switch to it at the same moment, which is 'harmonise' their summer time adjustment
European summer time	When European summer time is activated, it should change the time when the country / UTC zone is doing it.
Holidays	Holidays function is only available for room thermostat view of PC-ARFH2E. Holidays let the user specify a date and hour for the Room Setting to be OFF with the configured setting.

11.1.3 Optional external input/output configuration signals

The system has 7 input and 4 output optional signals (+ 4 output signals when using accessory). The new YUTAKI series allow different ports to be configured for those I/O signals, as well.

The user can configure those input signal to perform different functions from the unit controller. This is briefly explained in the next tables:

Input signals and input ports

Code	Name	Port	Input
,1	Input 1	TB2 #13&14	230 V
,2	Input 2	TB2 #13&15	230 V
,3	Input 3	TB2 #16&17	230 V
,4	Input 4	TB2 #16&18	230 V
,5	Input 5	TB2 #16&19	230 V
,6	Input 6	TB2 #16&20	230 V
,7	Input 7	TB2 #16&21	230 V

Input functions (To be configured from the unit controller)

Function #	Input	Description
0	Deactivated	-
1	Demand ON/OFF	Send Demand ON or OFF Operation to Circuit 1 and Circuit 2
2	Smart Act./SG Ready Input 1	This function must be used to block or limit the heat pump when restricted by Electric company. It allows an external Smart switch device to switch off or reduce consumption of the heat pump during time of peak electricity demand. In case of use of Smart Grid Ready application, this input is used as a digital input 2 and allows four different operating modes
3	Swimming pool	Input used to let YUTAKI know swimming pool is in demand On conditions.
4	Solar	In case of combine YUTAKI with solar panels, this input is used as a feedback for solar station ready operation.
5	Operation mode	Cool/Heat must be changed by an input of an external contact signal. Contact signal is edge detection; Cool/Heat changeover by unit controller is also available
6	DHW boost	With this function enabled, it is possible to request a heating up of the DHW when user requires an instantaneous delivery of DHW.
7	Power meter 1	Input used as kW/h pulse count for Energy data recording
8	Demand ON/OFF C1	Send Demand ON or OFF Operation only to Circuit 1
9	Demand ON/OFF C2	Send Demand ON or OFF Operation only to Circuit 2
10	Forced heating	Forced Heating Demand by input of contact signal from outside
11	Forced cooling	Forced Cooling Demand by input of contact signal from outside
12	Power meter 2	Input used as kW/h pulse count for Energy data recording
13	ECO mode C1 & C2	Water temperature setting for Circuit 1 and Circuit 2 it is reduced by ECO operation mode (Default 3°C) by input of contact signal from outside
14	ECO mode C1	Water temperature setting for Circuit 1 it is reduced by ECO operation mode (Default 3°C) by input of contact signal from outside
15	ECO mode C2	Water temperature setting for Circuit 2 it is reduced by ECO operation mode (Default 3°C) by input of contact signal from outside
16	Force OFF	Force OFF operation for unit. RCS will continue as normally set but will show indication that operation is forbidden
17	SG Ready Input 2	In case of want to use Smart Grid Ready application, this input is used as a digital input 2 and allow four different operating modes
18	Drain pump	In case of configuring this input, alarm is triggered in case input contact is opened. This input can be linked to drain pump kit accessory located at drain pane which by means of a NC contact, notifies there is possibility of water overflow.

Output signals and output ports

Code	Name	Port	Output
o1	Output 1	TB2 #34 (N) & 35 (L)	230 V
o2	Output 2	TB2 #34 (N) & 36 (L)	230 V
o3	Output 3	TB2 #37&38	Free voltage signal
o4	Output 4	TB2 #39&40	Free voltage signal
o5	Output 5	PCN20 #1-2	12Vdc signal
o6	Output 6	PCN21 #1-2	12Vdc signal
o7	Output 7	PCN22 #1-2	12Vdc signal
o8	Output 8	PCN23 #1-2	12Vdc signal
o9	Output 9 (only for YUTAKI S COMBI)	PCN12 #1-2	230 V

Output functions (To be configured from the unit controller)

Function #	Output	Description
0	Deactivated	
1	3WV SWP	In case of combine YUTAKI with swimming pool, this output is used to drive 3 way valve swimming pools.
2	WP3	In case of combine YUTAKI with boiler or hydraulic separator, this output is used to drive water pump 3.
3	Boiler combination	In case of combine YUTAKI with boiler, this output is used to switch ON it.
4	Solar pump	In case of combine YUTAKI with solar panel, this output is used to drive water pump station
5	Alarm signal	Output when an "Alarm Code" is received from Indoor Unit or outdoor unit.
6	Operation signal	Output in case that "Thermo-ON" signal in any condition.
7	Cooling signal	Output in case that "Thermo-ON" signal in Cooling operation.
8	Demand-ON signal circuit 1	Signal is enabled when circuit 1 is operating in Demand-ON.
9	Heating signal	Output in case that "Thermo-ON" signal in Heating operation.
10	DHW signal	Output in case that "Thermo-ON" signal in DHW operation.
11	Solar overhear	Output in case that solar temperature signal is active when solar overhear (only when solar combination status is total control).
12	Defrost	Output if the operation state of the outdoor unit when is defrosting.
13	DHW re-circulation pump	In case of re-circulation pump enabled for HSW tank.
14	Fan 1 Low speed	Output for fan coil speed.
15	Fan 1 Medium speed	Output for fan coil speed.
16	Fan 1 High speed	Output for fan coil speed.
17	Fan 2 Low speed	Output for fan coil speed.
18	Fan 2 Medium speed	Output for fan coil speed.
19	Fan 2 High speed	Output for fan coil speed.
20	Constant Heat	Output in high state whenever operation mode from Unit controller is in heating mode.
21	Constant cool	Output in high state whenever operation mode from Unit controller is in cooling mode

11.2 Additional functions by accessory sensor

Hitachi offers to its users the option to add more functions to the inputs from signals coming from some specific sensors. The configuration for this purpose is explained below:

I/O Terminal name		Port for setting (Connector number)	Factory default setting		Input/Output type
I/O	Display		Setting contents	Function #	
Sensor 1	A1	CN26 #2	Deactivated	0	NTC
Sensor 2	A2	CN25 #1-2	Deactivated	0	NTC
Sensor 3	A3	CN5 #1	Deactivated	0	NTC

Function of sensors

Function #	Input	Description
0	Deactivated	
1	T _{wo3} sensor	T _{wo3} sensor is required when there is external heating source or useful to track better temperature when there is hydraulic separator or buffer tank.
2	Swimming pool	When combining YUTAKI with swimming pool, this sensor is used to read the temperature from the water of the swimming pool.
3	Solar panel sensor	When combining YUTAKI with solar panels, this sensor is used to read the temperature from the solar panel.
4	Zone 1 & 2 ambient sensor	If Aux1 and Aux2 sensors are both connected and enabled at the unit controller configuration, the detection of ambient temperature value is carried out by these sensors. The ambient temperature setting for each circuit is set from the unit controller or central platform. The temperature value detected by each sensor is applied to the corresponding circuit.
5	Zone 1 ambient sensor	If Aux1 and Aux2 sensors are both connected and enabled at the unit controller configuration, the detection of ambient temperature value is carried out by these sensors. The ambient temperature setting for each circuit is set from the unit controller or central platform. The temperature value detected by each sensor is applied to the circuit 1.
6	Zone 2 ambient sensor	If Aux1 and Aux2 sensors are both connected and enabled at the unit controller configuration, the detection of ambient temperature value is carried out by these sensors. The ambient temperature setting for each circuit is set from the unit controller or central platform. The temperature value detected by each sensor is applied to the circuit 2.
7	Second outdoor ambient	An outside temperature sensor can be directly connected to the controller in case the heat pump is located in a position not suitable for this measurement.

11.3 Change of defrost condition

These optional function is available for being selected using the PSW switches and 7-segment on the PCB of the Outdoor Units:

Indication	Description	Application
Ⓜⓐ	Change of defrost condition	This function allows to shift the temperature conditions in order to cause an earlier defrosting. It is useful in installations placed in very cold regions, where frost generates continuously; enabling an earlier defrosting operation results in a lower amount of accumulated frost, therefore keeping higher heating capacity values.
F9	Defrost improvement (only for RAS-(2-3) WHVRP1, option available from udapte software H-0235)	In case F9 is set to 1, this optional function allows to perform defrost operation earlier in order to avoid excessive frost formation. In case F9 is set to 2, same conditions than 1 are applied and also EVO control is smoothed to avoid frost formation.

Example for RAS-(2-3)WHVRP1

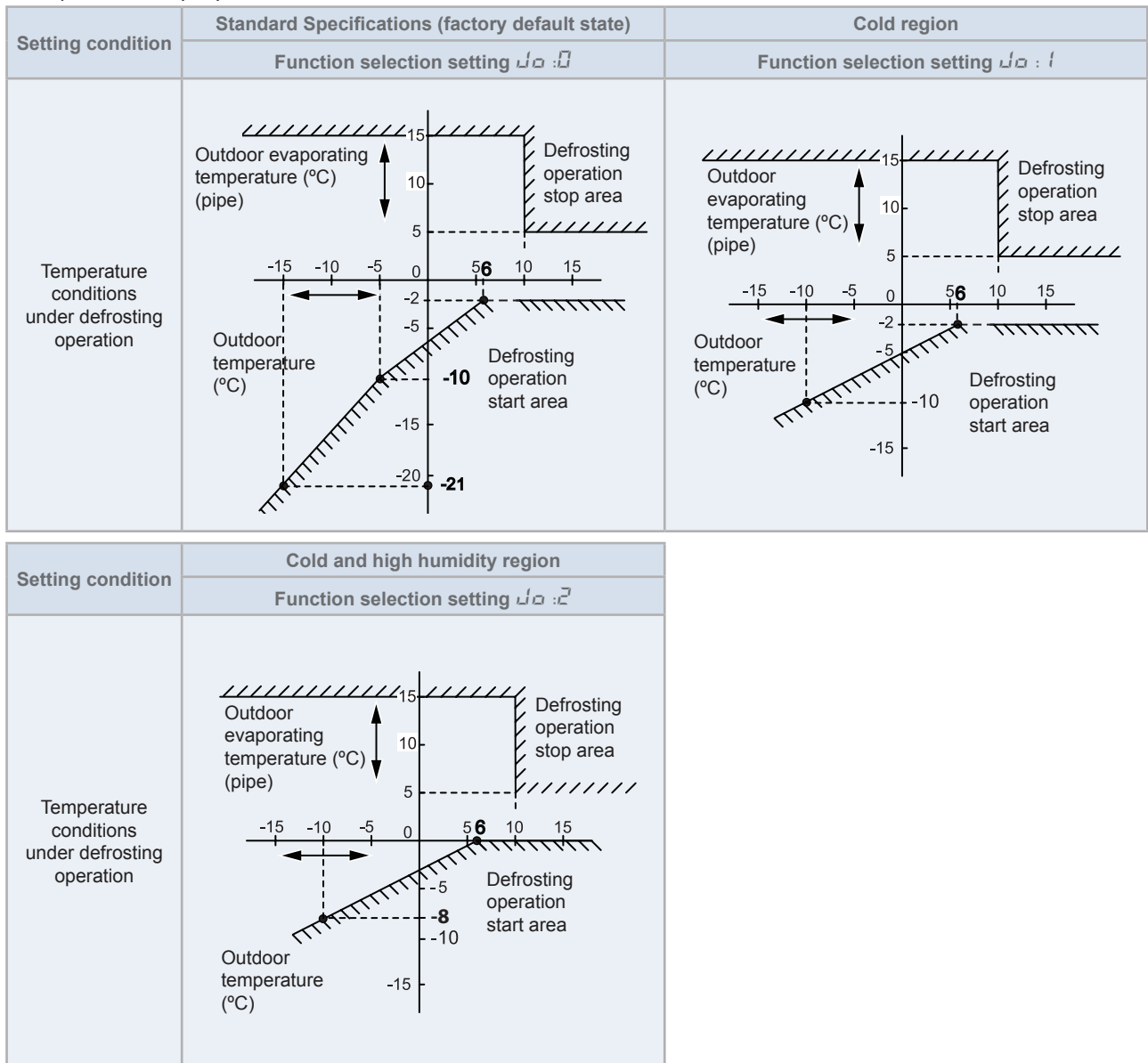

Example for RAS-(4-10)WH(V)NPE

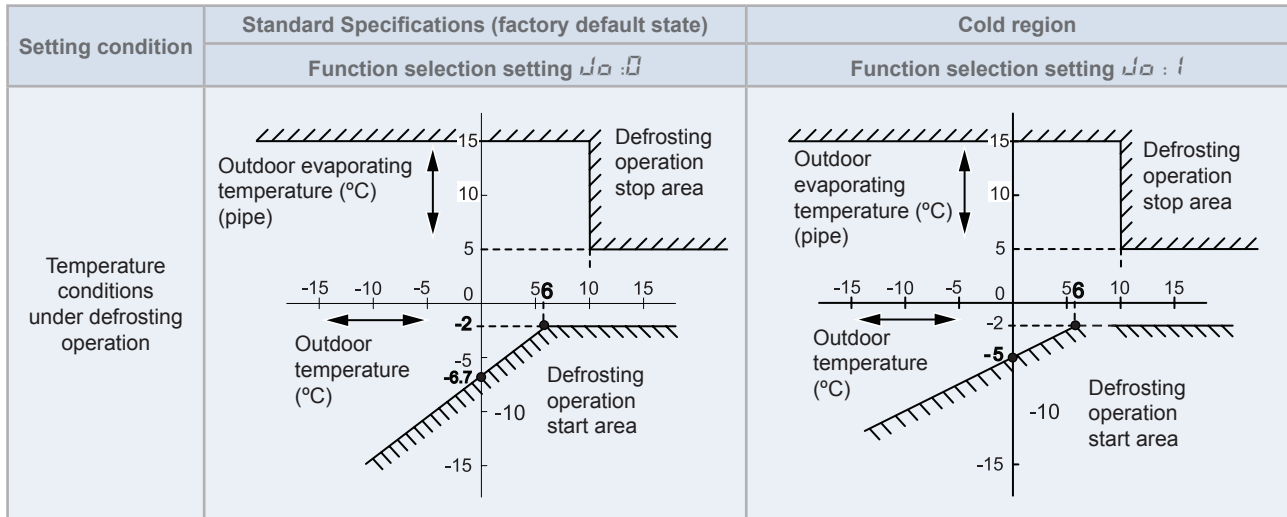

11.4 Output/input signals for outdoor units

◆ Output signals through 7-segment display on the unit PCB

The system has several output signals, which can be selected using the following connectors of the outdoor unit:

- Output connector CN7, which has two ports to configure two optional output signals.

The selection of these output signals represents the selection of some optional functions programmed in the PCB of the RAS unit through the 7-segment display.

i NOTE

- Do not set same function to multiple output ports. If set, the setting of the higher output number is cleared to $\square\square$.
- Please refer to the Service Manual for detailed information of optional external input and output signals.

◆ Output signals on outdoor units

Indication	Output signal	Application
$\square\square$	No setting application	No setting.
f	Operation signal	This signal allows to notify that the unit is operating. It enables to start up additional systems such as humidifiers, fans and other additional air-conditioning systems.
2	Alarm signal	This signal allows to notify that protection devices have been activated and to transfer it to additional systems.
3	Compressor ON signal	This signal allows to notify that the compressor is activated. This function can be applied for situations such as checking signals during remote-control operation and for the interlock of the RAS unit.
4	Defrost operation signal	This signal allows to notify that the unit is under defrosting operation.

12. Complementary system CASCADE CONTROLLER

Index

12.1	Main features.....	166
12.1.1	Multi configurations	166
12.1.2	Installation benefits.....	167
12.1.3	Maintenance benefits	169
12.1.4	Control features.....	169
12.1.5	CASCADE control	171
12.1.6	Rotary token control	172
12.1.7	Synchronized defrost.....	173
12.2	General data.....	173
12.3	Electrical data.....	173
12.4	Name of parts.....	174
12.5	Service space.....	175
12.6	Electrical wiring	176
12.7	Transmission wiring.....	177
12.7.3	Summary of the terminal board connections for YUTAKI CASCADE CONTROLLER.....	179
12.7.4	Location of DIP switches and rotary switches	180
12.7.4.1	Function of DIP switches and rotary switches.....	181
12.7.4.2	LED indication	184
12.8	Optional functions.....	185
12.8.1	Optional functions by DSW setting.....	185
12.8.2	Optional functions by Unit controller (PC-ARFH2E).....	186
12.8.2.1	Optional functions for Space Heating or Space Cooling.....	186
12.8.2.2	Optional functions for DHW.....	186
12.8.2.3	Optional functions for Heat pump.....	187
12.8.2.4	Optional functions for Unit controller (PC-ARFH2E).....	188
12.8.3	Optional external input/output configuration signals.....	188
12.9	Additional functions by accessory sensor	190

12.1 Main features

The YUTAKI CASCADE CONTROLLER is designed as an extension of the hydraulic control of YUTAKI range to establish a larger and efficient heating or cooling system. When YUTAKI CASCADE CONTROLLER function is active, system separate water generation (hot or cold) from water distribution and consumption.

Water generation is performed on YUTAKI Sub units, and water distribution and consumption is done on Main YUTAKI CASCADE CONTROLLER unit.

- Is a central control device capable to control Sub units that produce hot or cool water.
- Is capable to control up to 8 YUTAKI outdoor/indoor units.
- Allows to control the following heating indoor unit models:
 - YUTAKI S (from 4 to 10 HP)
 - YUTAKI S COMBI (from 4 to 6 HP)

12.1.1 Multi configurations

The new CASCADE CONTROLLER has been designed so it can be easily installed in multiple types of system. The following examples and illustrations are for illustrative purpose and not cover all the possible installations.

◆ Individual Heating/Cooling household in combination with common DHW production

This installation is suitable in case a high amount of DHW at a specific setting temperature is required.

When YUTAKI CASCADE CONTROLLER is generating water for DHW tank, production of hot or chilled water for Space Heating/Cooling application is stopped until DHW production stops.

In this scenario, YUTAKI CASCADE CONTROLLER manage DHW tank and Water temperature production for Space Heating or Cooling:

- C1 buffer tank depicted in the picture is C1 circuit for YUTAKI CASCADE CONTROLLER.
- C1 buffer tank is managed by means YUTAKI CASCADE CONTROLLER unit without thermostat.
- Each C2 circuit of each YUTAKI Sub unit is assigned to a specific household.
- Each C2 mixing kit of each YUTAKI Sub unit guarantees C2 water temperature at each household.
- Each C2 circuit can have a wired or wireless thermostat which is connected to each Sub unit
- Each C2 circuit can have an Outdoor OTC Temperature by Outdoor unit or Wired Sensor accessory.

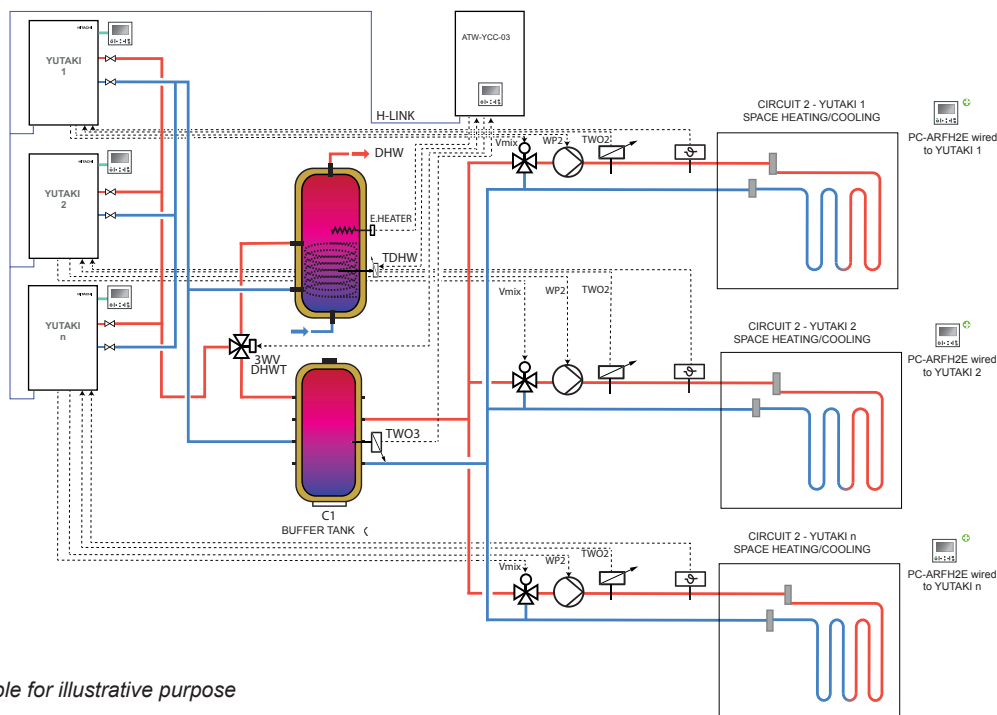

Example for illustrative purpose

i NOTE

Refer to the installation manual for more installation examples.

12.1.2 Installation benefits

◆ H-LINK connection between YUTAKI Sub Units and the CASCADE CONTROLLER

The YUTAKI Units and the CASCADE CONTROLLER are interconnected through the H-LINK II bus, consisting of 2 non-polarity cables and accepting lengths of up to 1,000 m.

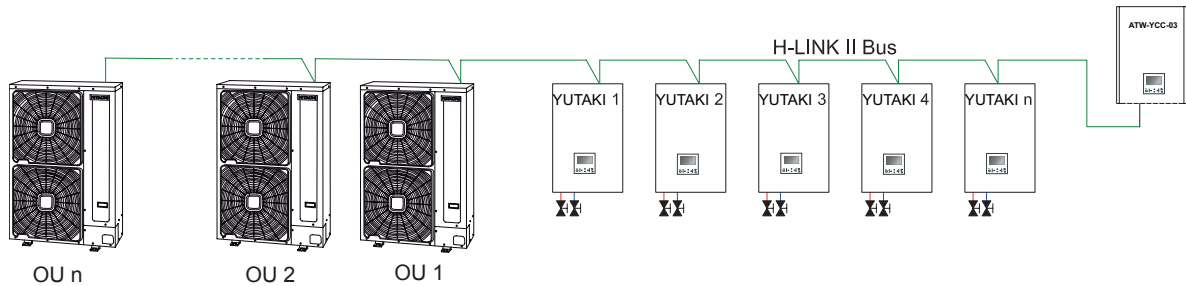

◆ No additional device into each Sub unit

No additional devices need to be installed into individual heat pumps.

◆ Universal mounting concept

The YUTAKI CASCADE CONTROLLER is designed for direct wall mounting.

The shape of the screw holes allows to preset the screws on the wall, then placing the electrical box and finally tightening the screws.

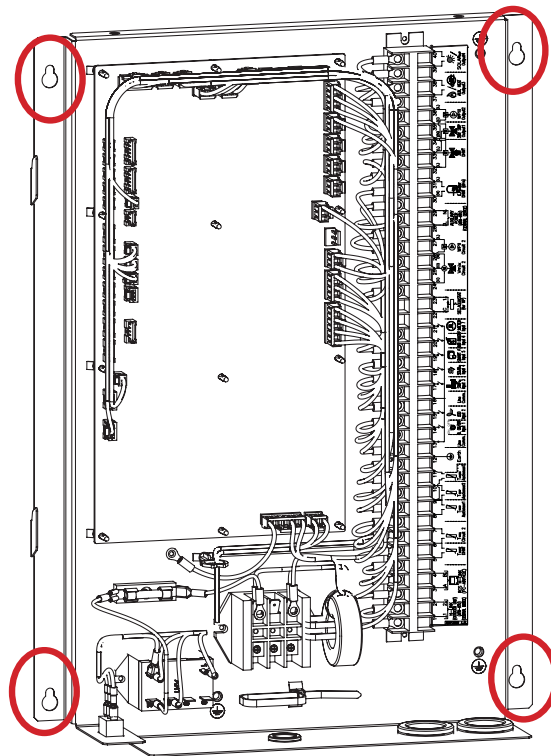

◆ **Connection by areas**

The connections for power supply and optional function are placed in separate areas of the terminal board.

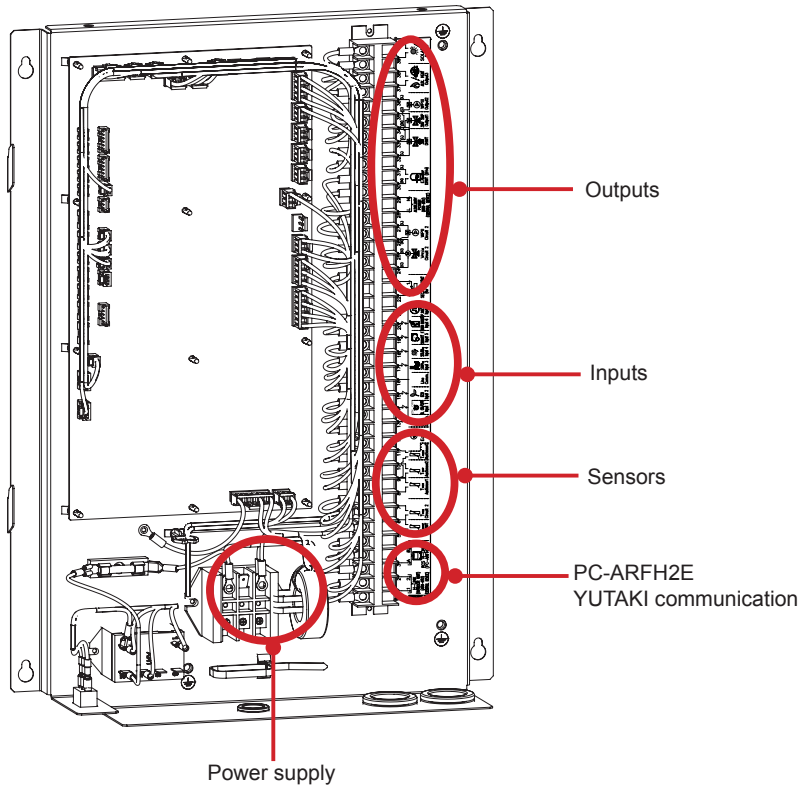

◆ **Electrical box with Easy Cover (Service cover)**

The service cover can be easily placed by just fitting the holes in the cover with the tabs on the electrical box, then fixing two screws at the top side.

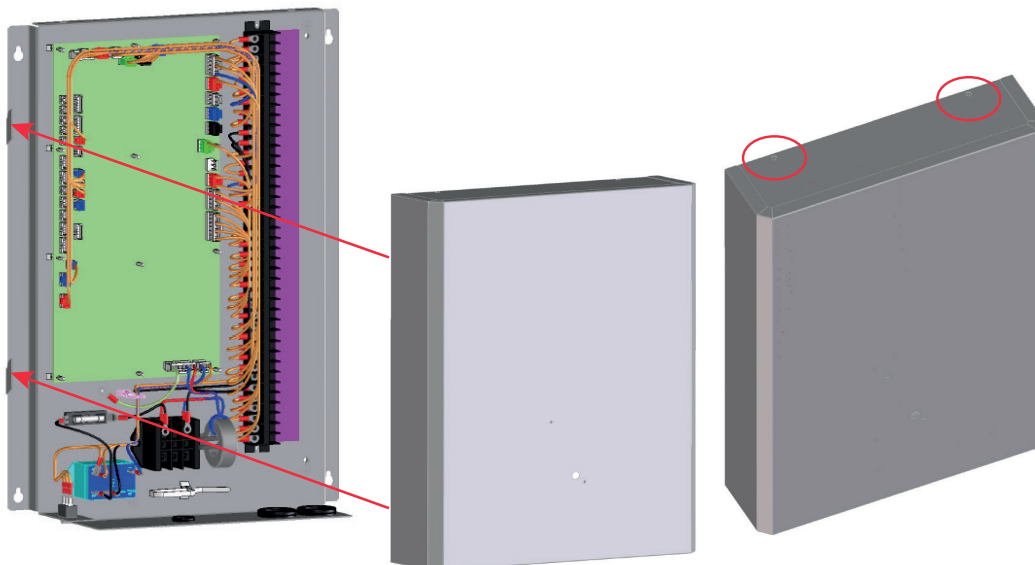

12.1.3 Maintenance benefits

◆ Checking of the operational data of the Sub unit

The CASCADE CONTROLLER allows monitoring the status of Sub units and therefore provides the user with information about the status of the whole system. The parameters that can be checked for each Sub module are the following:

- Operation status for Sub unit "n"
- Water inlet temperature for Sub unit "n"
- Water outlet temperature for module "n"
- Outdoor unit compressor frequency for module "n"
- Status of DHW for module "n"
- Type of DHW production (Main or Sub) in case that "Status of DHW" for module "n" is "Enabled"

◆ Alarm control

The CASCADE CONTROLLER has been designed in order to manage alarm notifications generated at the CASCADE CONTROLLER side and also alarms generated at the Sub unit side. In any case, both types of alarms are displayed at the bottom-left corner of the display of the LCD controller as it is done on the YUTAKI Unit.

- CASCADE CONTROLLER alarms: These alarms are generated at the CASCADE CONTROLLER side. Alarms can be due to factors such as sensor abnormality, wrong setup of the CASCADE CONTROLLER, high temperature limitation, freeze protection or abnormalities related to wireless thermostats. Some of these alarms trigger protection controls allowing to continue the operation of the CASCADE CONTROLLER, while others stop the CASCADE CONTROLLER in order to protect the unit.
- Sub unit alarms: Alarms generated at the Sub unit side are displayed at the LCD controller with alarm code 21X, where X indicates the number of the Sub unit in which the alarm occurred. For instance, should an alarm of any kind (thermistor, flow, wireless thermostat...) occur in Sub module 3, it is displayed in the LCD controller as "Alarm 213". As a rule, operation of the CASCADE CONTROLLER is not stopped in the event of a Sub unit alarm. The only case in which the operation of the CASCADE CONTROLLER is stopped due to Sub unit alarms (and emergency operation starts as long as it is enabled) is when all the Sub units in the system are in alarm.

12.1.4 Control features

◆ I/O and sensor functions

The terminal board of the new YUTAKI CASCADE CONTROLLER allows a wide range of configurations, just as in the YUTAKI units. In addition to factory presets, the unit controller offers the possibility to adjust the detailed settings of every input, output and sensor port.

The factory default functions of the controller are those indicated in the label of terminal 2, as shown below:

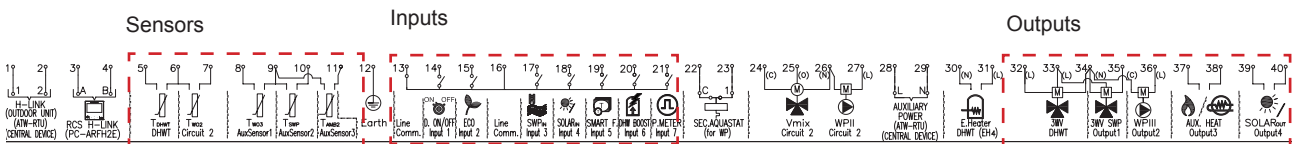

The following input, output and sensor functions can be selected in the "I/O and Sensor" menu of the controller:

Optional outputs:

There 4 additional available outputs to set. These 4 additional outputs are not wired to the YUTAKI terminal board.

In order to use them it is required accessory (field supplied). Its configuration follow same constrains as Standard outputs.

Auxiliary sensors:

There are 7 available auxiliary sensors to set.

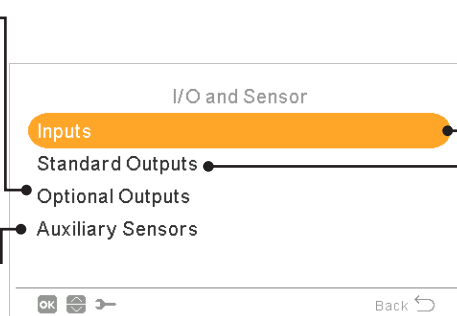

Inputs:

The system allows to set 7 inputs depending on the operations and preferences of the installation

Standard Outputs:

There are 4 available outputs to set already wired to the terminal board. There are conditions of setting depending on the installation

◆ List of available inputs

- **Deactivated**
- **Demand ON/OFF** (by default in input 1): Consider both Circuit 1 and Circuit 2 in Demand ON when the signal is ON.
- **Demand ON/OFF C1**: Consider Circuit 1 in Demand ON when the signal is ON.
- **Demand ON/OFF C2**: Consider Circuit 2 in Demand ON when the signal is ON.
- **Power Meter 2**: To count any pulse received from the power meter 2 and sent to central control energy consumption calculation.
- **ECO C1 + C2**: Switch both Circuit 1 and Circuit 2 to ECO mode when input is closed.
- **ECO C1** (by default in input 2, if there is circuit 1 in the installation): Switch Circuit 1 to ECO mode when input is closed.
- **ECO C2**: Switch Circuit 2 to ECO mode when input is closed.
- **Forced Off**: Forbid DHW, space heating and space cooling.
- **Smart Act / SG1** (Fixed in input 5 if smart action is enabled): To active Smart Function.
- **Swimming Pool** (Fixed in input 3 if swimming pool is enabled): Consider Swimming pool in Demand ON when the signal is ON.
- **Solar** (Fixed in input 4 if solar is enabled): To let YUTAKI know that external Solar management system is ready to provide Solar energy.
- **Operation**: To switch between space cooling and space heating.
- **DHW Boost** (Fixed in input 6 if is DHW Boost is enabled): If it is set to open (NC), boost signal ON if circuit is open. If it is set to close (NO), boost signal ON if circuit is closed.
- **Forced Heating**: Force mode heating when input is closed
- **Forced Cooling**: Force mode cooling when input is closed.
- **SG2**: To active the different estates of Sm Grid Ready.

◆ List of available outputs

- **Deactivated**
- **SWP 3WV**: (Fixed in output 1 if swimming pool is enabled): Signal control of the 3-way valve of the swimming pool.
- **Water pump 3**: (Fixed in output 2 if buffer tank is installed): Signal control of the water pump for buffer tank.
- **Boiler**: (Fixed in input 3 if boiler is enabled): Signal control of the boiler.
- **Solar Pump**: (Fixed in input 4 if solar pump is enabled): Signal control of the solar pump.
- **Alarm**: (By default in output 5): Signal is active if there is an alarm.
- **Operation**: (By default in output 6): Signal active in case Thermo ON in any condition.
- **Cooling**: (By default in output 7): Signal active when space cooling is operating.
- **Dem-ON C1**: (By default in output 8): Signal active when there is Demand in circuit 1.
- **Heating**: Signal active when space heating is operating.
- **DHW**: Signal active when DHW is operating.
- **Solar overheat**: Signal is active when solar overheat (only when solar combination status is total control)
- **Defrost**: Signal active when outdoor unit is defrosting.
- **DHW Re-circulation**: Signal active depending on option selected at chapter Circuit pump.
- **Fan 1 Low**: Signal is active when fan coil speed selected for Circuit 1 is set to Low.
- **Fan 1 Medium**: Signal is active when fan coil speed selected for Circuit 1 is set to Medium.
- **Fan 1 High**: Signal is active when fan coil speed selected for Circuit 1 is set to High.
- **Fan 2 Low**: Signal is active when fan coil speed selected for Circuit 2 is set to Low
- **Fan 2 Medium**: Signal is active when fan coil speed selected for Circuit 2 is set to Medium.
- **Fan 2 High**: Signal is active when fan coil speed selected for Circuit 2 is set to High.
- **Constant Heating**: Signal is active in case operation mode of LCD controller is set to Heating.
- **Constant Cooling**: Signal is active in case operation mode of LCD controller is set to Cooling.

◆ List of available sensors:

- **Deactivated**
- **T_{w03}**: (Fixed in sensor 1 if boiler is installed): Use this sensor to monitor water temperature when boiler is used.

- **Swimming Pool:** (Fixed in sensor 2 if swimming pool is installed): Use this sensor when swimming pool is used in order to monitor swimming pool temperature.
- **Solar panel sensor:** Use this sensor when Total control is configured to monitor Solar Panel temperature.
- **C1 + C2 Ambient:** Use this sensor when auxiliary ambient temperature sensor is used for C1 and C2.
- **C1 Ambient:** Use this sensor when auxiliary ambient temperature sensor is used for C1.
- **C2 Ambient:** Use this sensor when auxiliary ambient temperature sensor is used for C2.
- **Outdoor sensor (NTC):** (By default sensor 3) To connect to the controller an auxiliary outside temperature sensor in case the heat pump is located in a position not suitable for this measurement.

12.1.5 CASCADE control

The new CASCADE control determines whether a YUTAKI Sub unit has to be switched ON or OFF according to heating demand (Water temperature and Water setting temperature).

Up to 8 basic modules can be connected to the YUTAKI CASCADE CONTROLLER.

The combination of these modules operates as a single system, and allows to achieve higher capacities.

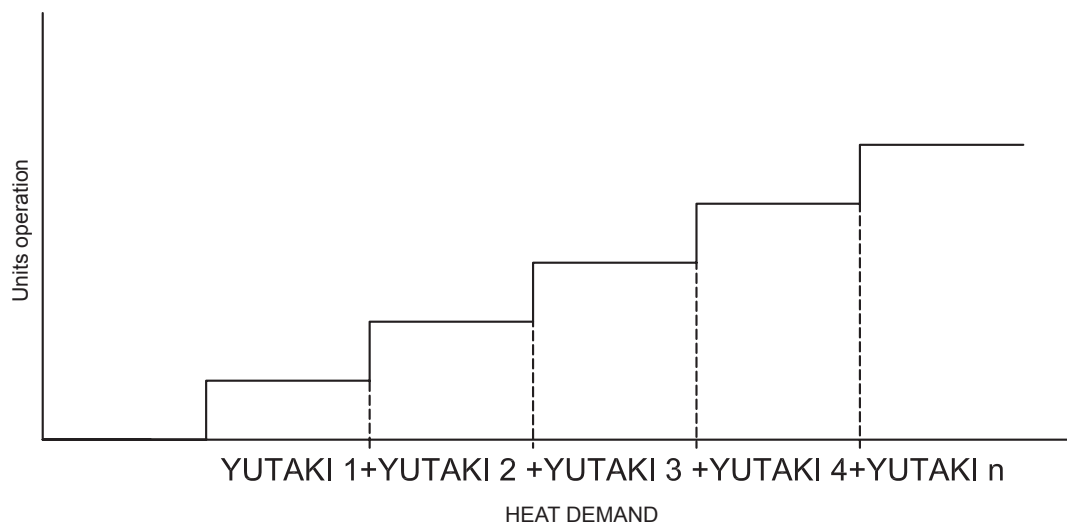

When this control determines that a unit has to be switched ON or OFF, it is the rotary token control which determines the concrete unit to be switched ON or OFF.

12.1.6 Rotary token control

A different Sub unit is started first in each heating up process, in order to balance operation between them.

In case that the CASCADE PID Control determines that a unit has to be switched ON in order to satisfy capacity requirements, the Rotary Control switches ON the “Next available Unit”.

In case that the CASCADE PID Control determines that a unit has to be switched OFF as it is no longer required to satisfy capacity requirements, the Rotary Control switches OFF the unit that had been switched ON in first place.

Example of Rotary Token Control diagram:

Time line (1 min)		SU-1	SU-2	SU-3	SU-4	SU-5	SU-6	SU-7	SU-8
1	All Units OFF	0	0	0	0	0	0	Disabled	0
2	PID determine to switch ON module. YCC switches ON next available Sub Unit	1	0	0	0	0	0	Disabled	0
3	PID determine to switch ON module. YCC switches ON next available Sub Unit	1	2	0	0	0	0	Disabled	0
4	PID determine to switch ON module. YCC switches ON next available Sub Unit	1	2	3	0	0	0	Disabled	0
5	PID determine to switch ON module. YCC switches ON next available Sub Unit	1	2	3	4	0	0	Disabled	0
6	PID determine to switch ON module. YCC switches ON next available Sub Unit	1	2	3	4	5	0	Disabled	0
7	Heat Demand. PID does not determine new Unit to be started	1	2	3	4	5	0	Disabled	0
8	Module 3 is in alarm. YCC switches ON new module instead	1	2	Unit in alarm	3	4	5	Disabled	0
9	PID determines to switch OFF a module. YCC switches OFF first module started	0	1	Unit in alarm	2	3	4	Disabled	0
10	PID determines to switch OFF a module. YCC switches OFF first module started	0	0	Unit in alarm	1	2	3	Disabled	0
11	PID determines to switch ON Module. YCC switches ON next available Unit	0	0	0	1	2	3	Disabled	4
12	PID determine to switch ON module. YCC switches ON next available Sub Unit	5	0	0	1	2	3	Disabled	4
13	Sub Unit switches to DHW operation. DHW Sub Unit also. YCC switches ON same amount of Units	3	4	5	Unit ON for Sub DHW tank	Unit ON for Main DHW tank	1	0	2
14	PID determines to switch OFF a module. YCC switches OFF first module started	2	3	4	Unit ON for Sub DHW tank	Unit ON for Main DHW tank	0	0	1
15	PID determines to switch OFF a module. YCC switches OFF first module started	1	2	3	0	0	0	0	0
16	In case of Thermo OFF or Demand OFF, YCC switches OFF all modules	0	0	0	0	0	0	0	0

■	Unit OFF
■	Unit ON for C1
■	Unit ON for Main DHW tank
■	Unit ON for Sub DHW tank
■	Unit in alarm
■	Disabled

12.1.7 Synchronized defrost

The defrosting process of the YUTAKI Sub units operating with the Cascade Controller as a group has been improved in order to avoid the drop of heating capacity by not defrosting units at the same time.

The defrost operation of YUTAKI outdoor units connected to a Cascade Controller operating as a group is timed in order to limit the effect of the drop in heating capacity caused by simultaneous defrost. This improvement results in a more stable capacity and better comfort.

The beginning of defrosting operation of each YUTAKI outdoor unit is established according to the total number of units connected to the Cascade Controller and the individual need to defrost of each YUTAKI outdoor unit.

Number of YUTAKI units	Number of units in concurrent defrost
2 or 3	Only 1 YUTAKI can defrost
4 or 5	Only 1 YUTAKI can defrost
5 or 6	Up to 2 YUTAKI can defrost at the same time
6 or 7	Up to 2 YUTAKI can defrost at the same time
7 or 8	Up to 2 YUTAKI can defrost at the same time

12.2 General data

YUTAKI CASCADE CONTROLLER - ATW-YCC-03	
Power supply	1~ 230 V 50 Hz
Maximum current (with DHWT Electrical Heater) / Maximum current (Only Electrical BOX)	19 A / 5 A
Maximum input (with DHWT Electrical Heater) / Maximum input (Only Electrical BOX)	3.2 kW / 0.8 kW
Ambient temperature range in operation	0 to 40 °C
Humidity range in operation	0 to 80% RH non-condensing
Product dimensions	490 x 360 x 100 mm
Packaging dimensions	510 x 380 x 150 mm
Net weight	5.45 kg
Colour of the cover	White, RAL 9016
Maximum diameter of power wiring harness	12 mm

12.3 Electrical data

Model	Main unit power			Applicable voltage		MC [A]
	U [V]	PH	F [Hz]	U max [V]	U min [V]	
ATW-YCC-03 (with DHW E.Heater)	230	1~	50	253	207	16
ATW-YCC-03 (only EBOX)	230	1~	50	253	207	5

12.4 Name of parts

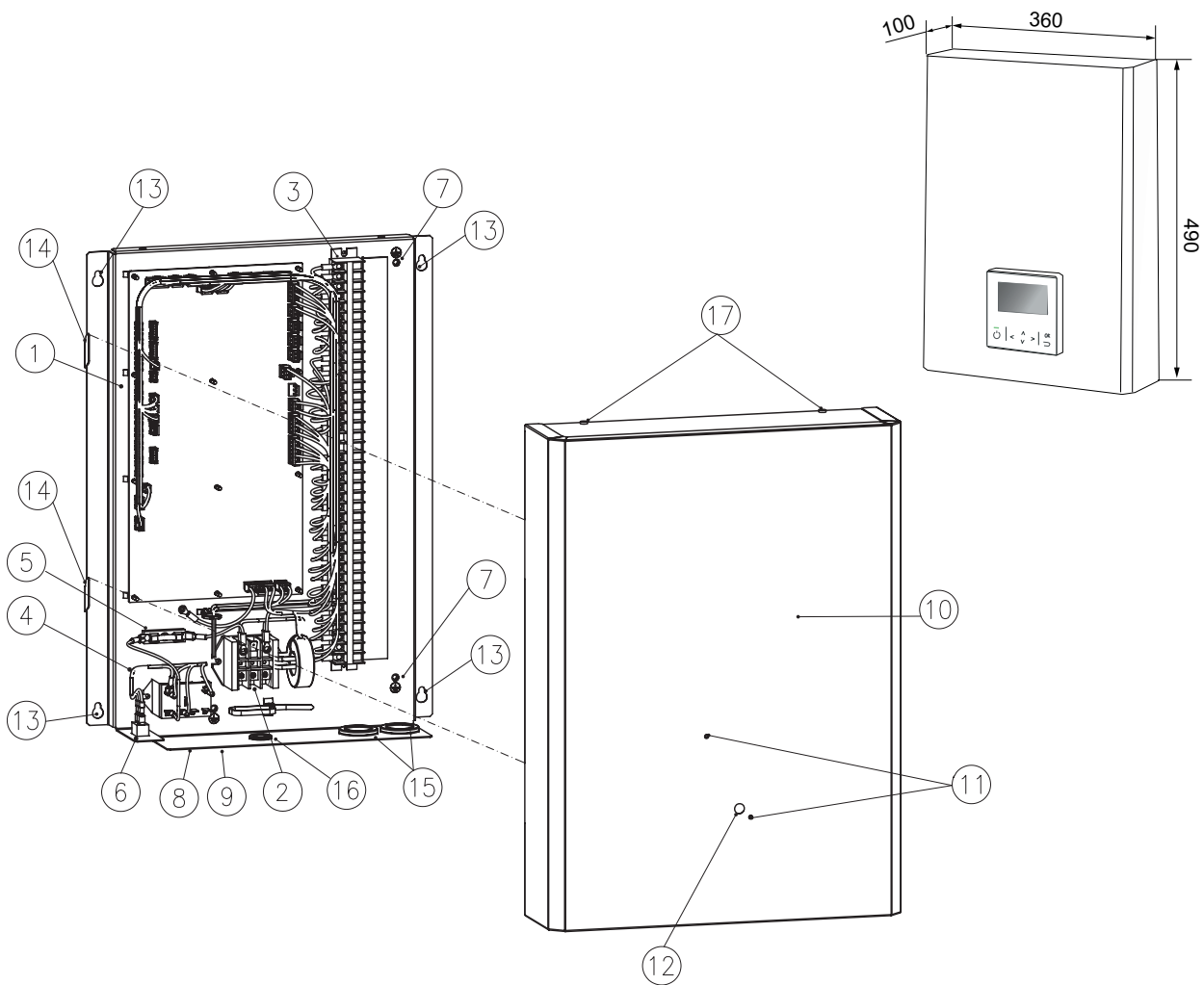

N°	Part name
1	Electrical Box
2	Terminal Board (TB1)
3	Terminal Board (TB2)
4	Relay (AR1)
5	Fuse (EF1) and Fuse holder
6	Switch for DHW emergency operation
7	Earth screw
8	Model Label (Bottom)
9	Electrical data label (Bottom)
10	Service cover
11	LCD unit controller assembly holes (x2)
12	LCD unit controller routing hole
13	Wall mounting holes (x4)
14	Service cover assembly hooks (x2)
15	Rubber bushing for control wiring (x2)
16	Rubber bushing for power supply wiring
17	Service cover fixation screws (x2)

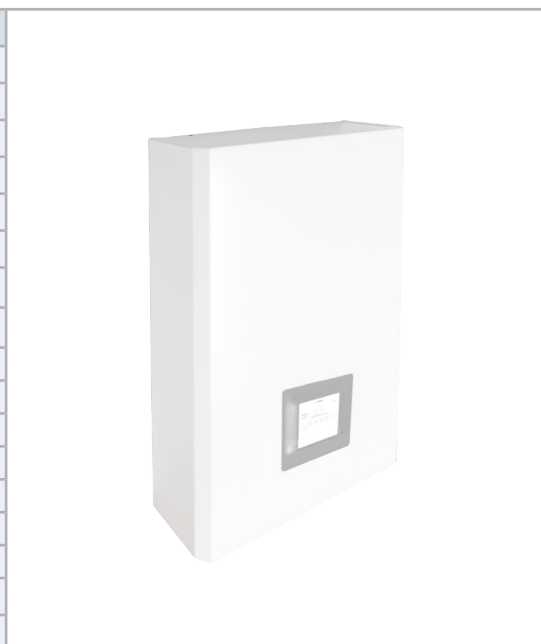

12.5 Service space

Units in mm.

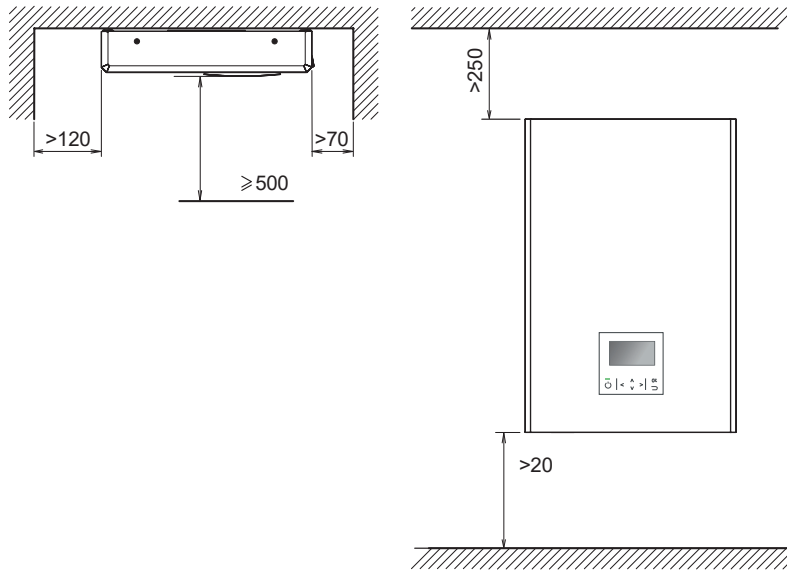

Keep a minimum distance for the installation of cables

Examples for placement

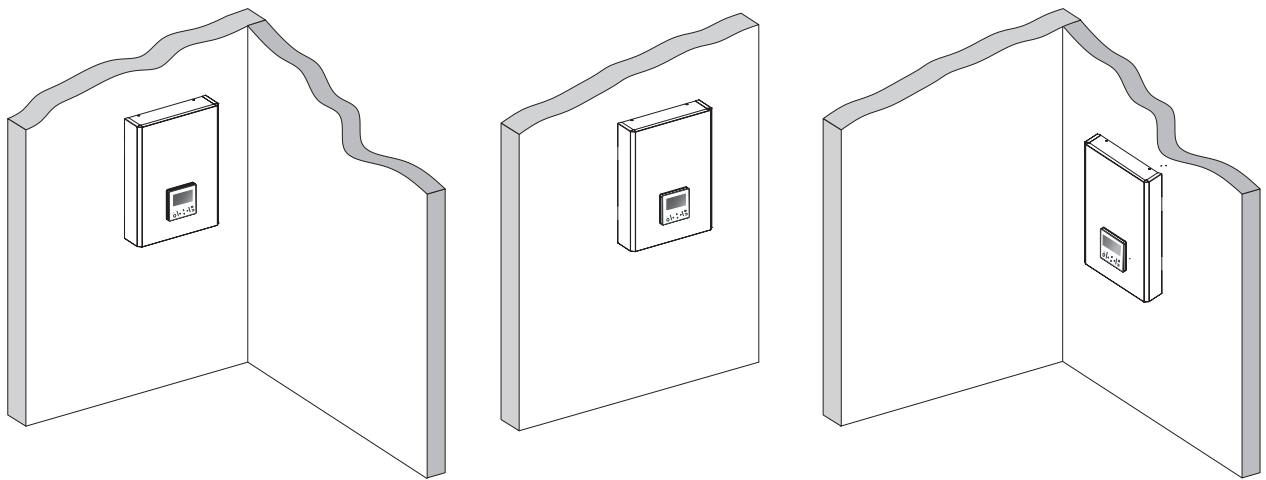

12.6 Electrical wiring

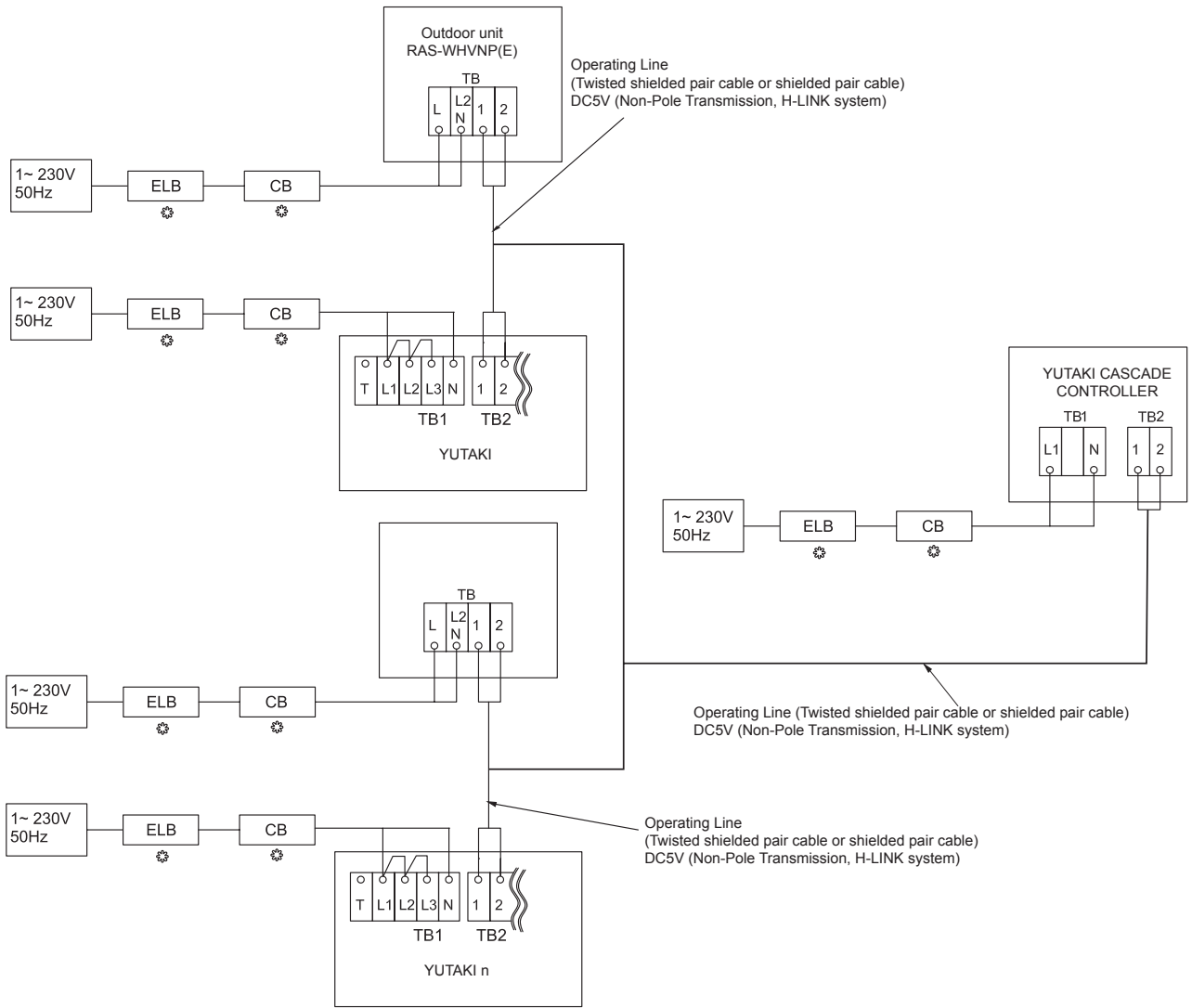

12.7 Transmission wiring

12.7.1 Connections on the Terminal board 1 (TB1)

The followings connections on the Terminal board 1 of the YUTAKI CASCADE CONTROLLER are required:

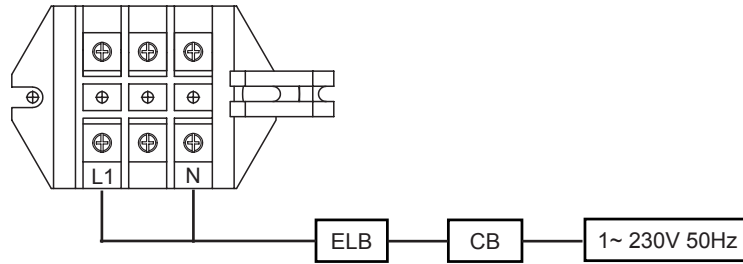

12.7.2 Connections on the Terminal board 2 (TB2)

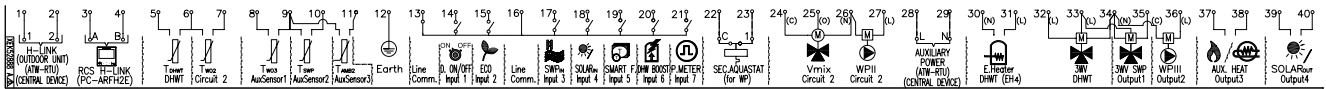

CAUTION

When installing the YUTAKI CASCADE CONTROLLER (ATW-YCC-03) electrical connections for the control of the system must be done on the terminal board 2 of the YUTAKI CASCADE CONTROLLER rather than perform those connections on the terminal board of the YUTAKI.

H-LINK connection

The YUTAKI units, YUTAKI CASCADE CONTROLLER and outdoor units are interconnected via bus called H-LINK II, consisting of 2 non-polarity cables and accepting lengths of up to 1000 m. All YUTAKI and Outdoor units which are controlled by the same YUTAKI CASCADE CONTROLLER unit must be connected at the same H-LINK II line:

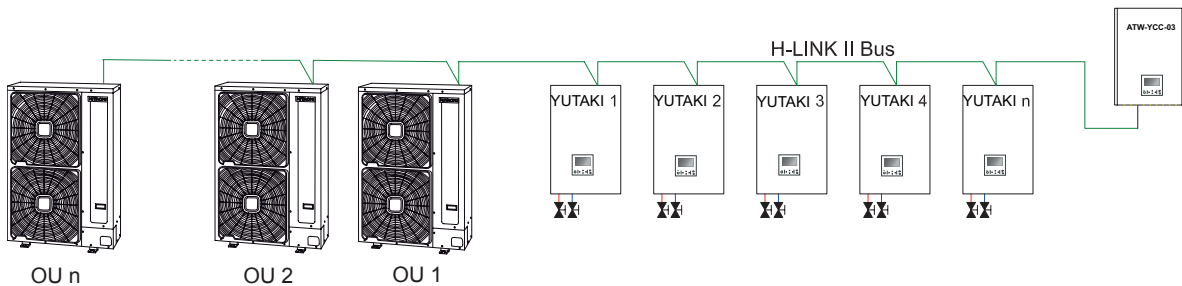

Setting of End Terminal Resistance

When connecting outdoor units to an H-LINK II line, it is necessary to set the end terminal resistance as active (DSW5-1 ON) in only one of the units. Pin 1 of DSW5 is factory set to ON in all the outdoor units. Therefore, when connecting multiple outdoor units to an H-LINK II line, please check and make sure that only one of the units has pin 1 of DSW5 set to ON, and the rest of the units have pin 1 of DSW5 set to OFF.

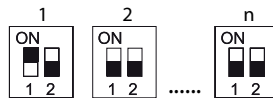

The H-LINK II connection must be done as it is shown in the figure below:

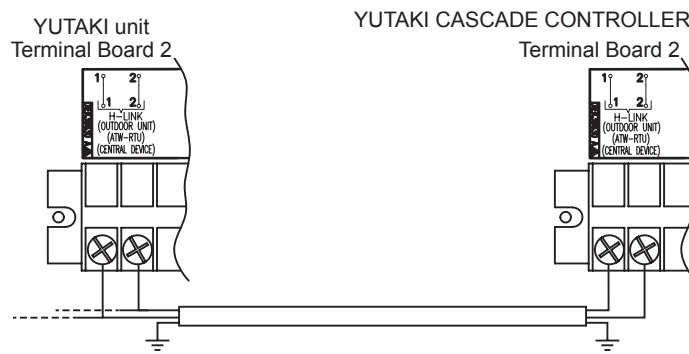

- The H-LINK wiring system requires only two transmission cables that connect the indoor unit and the outdoor unit.
- Use twist pair wires (0.75 mm²) for operation wiring between outdoor unit and indoor unit. The wiring must consist of 2-core wires (Do not use wire with more than 3 cores).
- Use shielded wires for intermediate wiring to protect the units from noise interference. Total H-LINK circuit length shall not exceed 1000m and a size in compliance with local codes.
- In the event that a conduit tube for field-wiring is not used, fix rubber bushes to the panel with adhesive.

CAUTION

Ensure that the transmission wiring is not wrongly connected to any live part that could be damaged the PCB.

◆ LCD unit controller (PC-ARFH2E) connection

Connection for the LCD unit controller PC-ARFH2E should be done on the Terminal Board 2 of the YUTAKI CASCADE CONTROLLER as shown in the next figure:

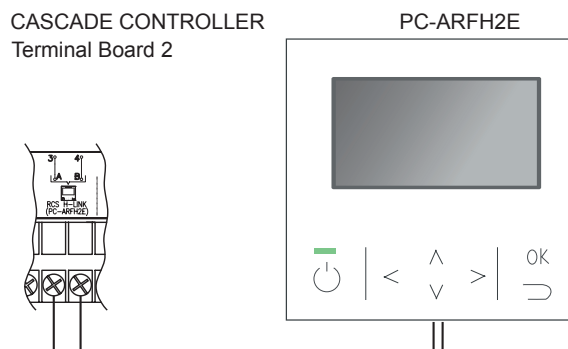

For this purpose, a H-LINK cable (accessory) is necessary.

The torque for the tightening of the screws of each Terminal board is explained in the table below

Terminal board	Tightening Torque (Nm/cm ²)
TB1	2.0~2.5
TB2	1.0~1.3

12.7.3 Summary of the terminal board connections for YUTAKI CASCADE CONTROLLER

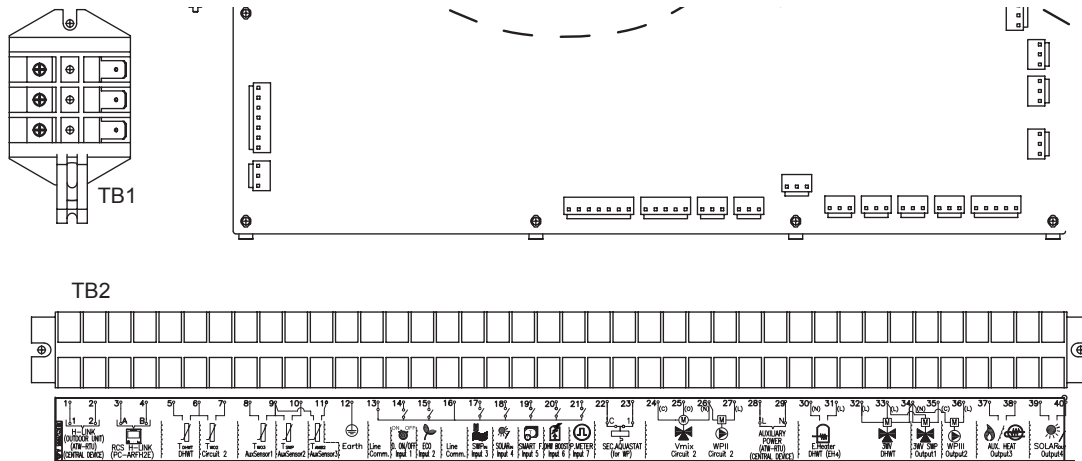

Mark	Part name	Description
TERMINAL BOARD 2 (TB2)		
1	H-LINK commutation	The H-LINK transmission has to be done between the indoor unit and the terminals 1-2 of either outdoor unit, ATW-RTU or any other central device.
2		
3	H-LINK communication for remote control switch	Terminals for the connection of the YUTAKI unit controller.
4		
5	DHW tank's thermistor	The DHW sensor is used to control the temperature of the domestic hot water tank.
6	Common thermistor	Common terminal for thermistor.
7	Thermistor for water outlet temperature of second cycle	The sensor is used for the second temperature control and should be positioned after the mixing valve and the circulation pump.
8	Thermistor for water outlet temperature after hydraulic separator	Water sensor for hydraulic separator, buffer tank or boiler combination.
9	Common thermistor	Common terminal for thermistors.
10	Thermistor for swimming pool water temperature	The sensor is used for the swimming pool temperature control and should be positioned inside plate heat exchanger of the swimming pool.
11	Thermistor for second ambient temperature	The sensor is used for the second ambient temperature control and it should be positioned outdoors.
12	Earth	Earth connection for the 3 way valve and water pump.
13	Common line	Terminal Line common for input 1 and input 2.
14	Input 1 (Demand ON/OFF) (*)	The air to water heat pump system has been designed to allow the connection of a remote thermostat to effectively control your home's temperature. Depending on the room temperature, the thermostat will turn the split air to water heat pump system ON and OFF.
15	Input 2 (ECO mode) (*)	Available signal which allows to reduce the water setting temperature of circuit 1, circuit 2 or both.
16	Common line	Terminal Line common for inputs 3, 4, 5, 6, 7.
17	Input 3 (Swimming pool) (*)	Only for swimming pool installations: It is necessary to connect an external input to the air to water heat pump to provide signal when the water pump of swimming pool is ON.
18	Input 4 (Solar) (*)	Available input for Solar combination with Domestic Hot Water Tank.
19	Input 5 (Smart function) (*)	For the connection of an external tariff switch device to switch OFF the heat pump during peak electricity demand period. Depending on the setting, the heat pump or DHWT will be blocked when signal is open/closed.
20	Input 6 (DHW boost) (*)	Available input for an instantaneous heating of the domestic hot water of the tank.
21	Input 7 (Power meter)	The measuring of the real power consumption can be done connecting an external power meter. The number of pulses of the power meter is a variable which must be set. By this, every pulse input is added into corresponding operation mode (Heating, Cooling, DHW Operation). Two possible options: - One power meter for all installation (IU+OU). - Two separated power meters (one for IU and one for OU).
22	Aquastat security for circuit 1 (WP1)	Terminals intended for the connection of the Aquastat security accessory (ATW-AQT-01) for controlling water temperature of the circuit 1.
23		

Mark	Part name	Description
24(C)	Mixing valve close	When a mixing system is required for a second temperature control, these outputs are necessary to control the mixing valve.
25(O)	Mixing valve open	
26(N)	N Common	
27(L)	Water Pump 2 (WP2)	When there is a second temperature application, a secondary pump is the circulating pump for the secondary heating circuit.
28	Auxiliary power	Power supply for ATW-RTU and central device.
29		
30(N)	Electrical Heater DHW Output	If DHW tank contains an electric heater, the air to water heat pump can activate it if the heat pump cannot achieve the required DHW temperature by itself.
31(L)		
32(C)	Common line	Common terminal for the 3-way valve for DHW tank.
33(L)	3-way valve for DHW tank	The air to water heat pump can be used to heat DHW. This output will be on when DHW is activated.
34(N)	N common	Neutral terminal common for 3-way valve of DHW tank and outputs 1 and 2.
35(L)	Output 1 (3-way valve for swimming pool) (*)	The air to water heat pump can be use to heat swimming pool. This output will be ON when swimming pool is activated.
36(L)	Output 2 (Water pump 3 (WP3)) (*)	When there is a hydraulic separator or buffer tank, additional water pump (WP3) is needed.
37	Output 3 (Auxiliary boiler or electric heater) (*)	The boiler can be used to alternate with the heat pump when the heat pump cannot achieve the required temperature by itself.
38		A water electric heater (as accessory) can be used to provide the additional heating required on the coldest days of the year.
39	Output 4 (Solar) (*)	Output for solar combination with Domestic Hot Water Tank.
40		

i NOTE

(*): Inputs and outputs explained in the table are the factory-set options. By means of the unit controller, some other inputs and outputs functions can be configured and used. Refer to the YUTAKI CASCADE CONTROLLER and the PC-ARFH2E technical documentation and operation manual for detailed information.

12.7.4 Location of DIP switches and rotary switches

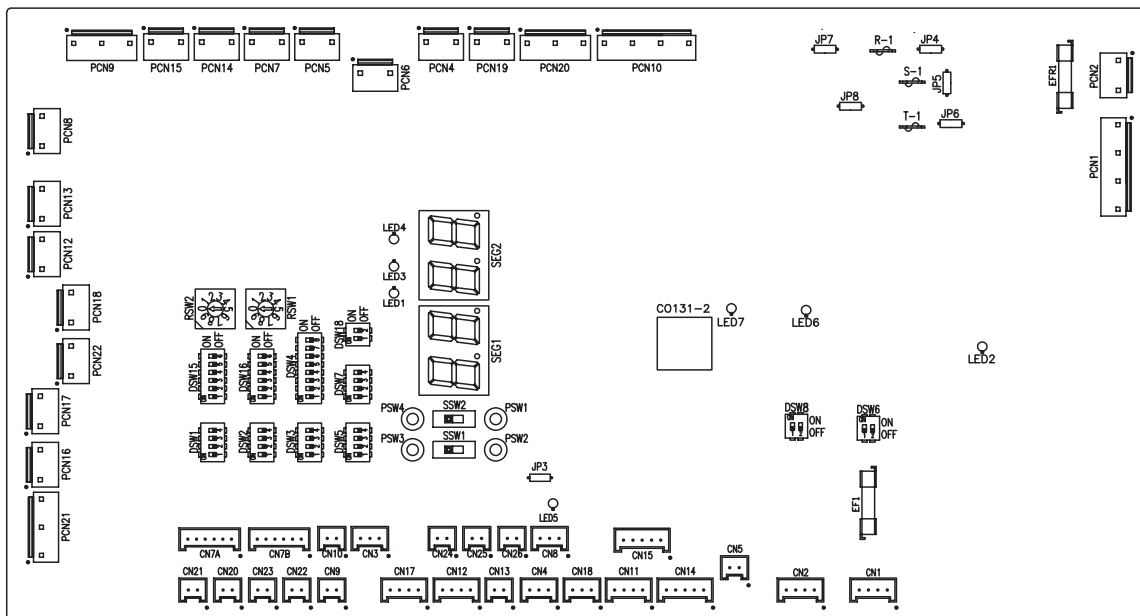

12.7.4.1 Function of DIP switches and rotary switches

i NOTE



- The mark “■” indicates the dip switches positions.
- No mark “■” indicates pin position is not affected.
- The figures show the settings before shipment or after selection.
- “Not used” means that the pin must not be changed. A malfunction might occur if changed.

! CAUTION

Before setting dip switches, first turn the power supply OFF and then set the position of dip switches. If the switches are set without turning the power supply OFF, the contents of the setting are invalid.

◆ DSW1: Model setting

Setting is required in order to match with the model of the Sub YUTAKI installed.







YUTAKI S (*)	
YUTAKI S COMBI (*)	

i NOTE

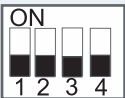
(*): In case of installing the “Cooling kit” accessory, set the pin 4 of DSW1 to ON in order to enable the cooling operation.

◆ DSW2: Unit capacity setting

Setting is required in order to match with the model of the Sub YUTAKI installed.

Factory setting	4.0 HP	5.0 HP	6.0 HP	8.0 HP	10.0 HP
					

◆ DSW3: Additional setting 1

Setting before shipment	
1-step heater for 3-phase unit	

◆ DSW4: Additional setting 2

Setting before shipment	
DHW defrost	
Heater forced OFF	
Unit and installation pipes antifreeze protection	





Standard / ECO water pump operation	
Electric heater or boiler emergency mode	
DHW tank's heater operation	

⚠ CAUTION

- Never turn all DSW4 dip switch pins ON. If this happens, the software of the unit will be removed.
- Never activate “Heater Forced OFF” and “Electric heater or boiler emergency mode” at the same time.

◆ DSW5: Additional setting 3

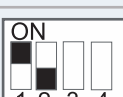

In the cases where the outdoor unit is installed into a location where its own outdoor ambient temperature sensor can not give a suitable temperature measurement to the system, it is available the 2nd outdoor ambient temperature sensor as accessory. By means of DSW1&2 setting, the preferable sensor for each circuit can be selected.

Factory setting	
Outdoor unit sensor for circuits 1 and 2.	
Outdoor unit sensor for circuit 1; Auxiliary sensor for circuit 2.	
Auxiliary sensor for circuit 1; Outdoor unit sensor for circuit 2.	
Auxiliary sensor instead of outdoor unit sensor for both circuits.	

◆ DSW6: Not used

Factory setting (Do not change)	
------------------------------------	---

◆ DSW7: Additional setting 4

Factory setting	
Compatibility with ATW-RTU-04 (When cooling mode operation is needed)	

◆ DSW8: Not used

Factory setting (Do not change)	
------------------------------------	---

◆ **DSW15 & RSW2: Refrigerant cycle number setting for YUTAKI CASCADE CONTROLLER**

Set and assign to each outdoor unit a different refrigerant cycle number through DSW4 and RSW1 on the outdoor units PCB.

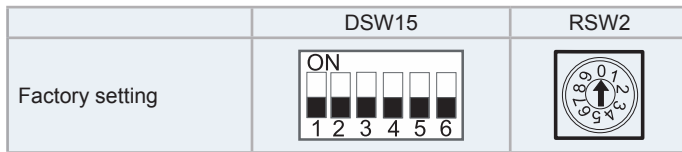

Set for each unit the same refrigerant cycle than its outdoor unit (DSW15 and RSW2).

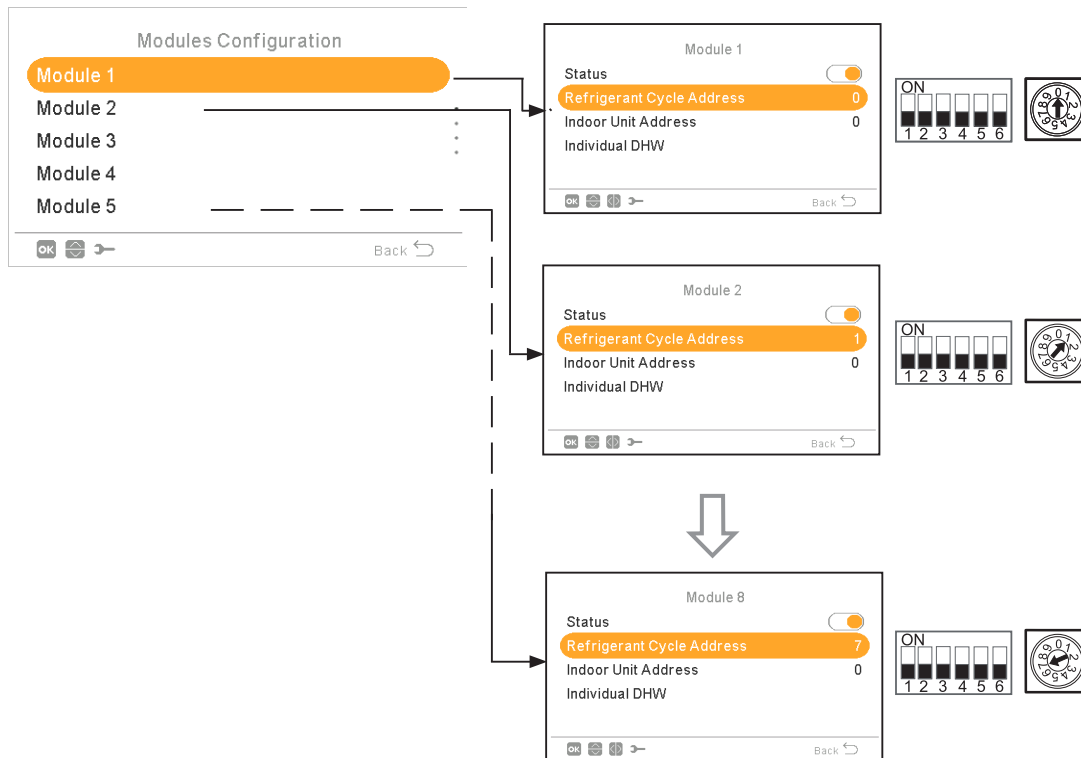

It is recommended to set the refrigerant cycle number from 0 and correlatively (1,2,3,....) per each module in order to match with the address number shown in the LCD remote controller. If a different rule is used for assign the refrigerant cycle number it is necessary to set the is set the same refrigerant cycle number in the LCD remote controller.

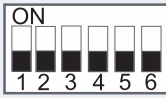

◆ **DSW16 & RSW1: Not used**

	DSW16	RSW1
Factory setting		

**NOTE**

Don't change this setting, otherwise malfunction will be occur.



◆ **SSW1: Remote/Local**

Factory setting	Remote	
Remote operation	Local(*)	

**NOTE**

(*) Don't change this setting, otherwise malfunction will be occur.

◆ **SSW2: Heat/Cool (when SSW1 is in local setting)**

Factory setting	Heat	
Heat operation	Cool(*)	

**NOTE**

(*) Don't change this setting, otherwise malfunction will be occur.

12.7.4.2 LED indication

Name	Colour	Indication
LED1	Green	Power indication
LED2	Red	Power indication
LED3	Red	Heat pump operation (thermo ON/OFF)
LED4	Yellow	Alarm (flickering with 1 sec interval)
LED6	Yellow	H-Link transmission
LED7	Yellow	H-Link transmission for unit controller

12.8 Optional functions

12.8.1 Optional functions by DSW setting

Code	Optional function description	Explanation
DSW1#4:ON 	Heating & Cooling (ON) Unit	In case of cooling operation, this DSW should be set to ON + Cooling kit accessory.
DSW3#3:ON 	1 step heater for 3 phase unit option	This option can be used to switch all 3 steps of the electric heater at the same time, by means of a DIP-switch setting, in order to prevent 3-phase imbalance by the electric heater steps.
DSW4#7:ON 	Heating Heater forced OFF	This function forces a permanent OFF of the heater when selecting an installation configuration without the electric heater of the unit.
DSW4#6:ON 	Unit and pipes installation freeze protection	This function allows to start water pump in very low conditions.
DSW4#5:ON 	Standard / Economic water pump operation	This function allows to stop water pumps when zone is in Demand OFF conditions in case mode selected is economic. Otherwise, pumps are always ON regardless zone is in Demand OFF conditions.
DSW4#4:ON 	Emergency Heater operation manual option	In the event of outdoor unit failure, the required heating can be provided by an electric heater or by a boiler.
DSW4#3:ON 	DHW Heater Operation	The electric heater of the domestic hot water tank is disabled by factory setting. This function allows to activate its operation if needed.
DSW5#1:OFF;2#OFF 	C1 : Average OU Sensor C2 : Average OU Sensor	A 2nd outdoor ambient temperature sensor is available as an accessory, in case that the built-in ambient temperature sensor of the outdoor unit cannot provide a reliable temperature measurement to the system because of restraints of the installation location. The preferred sensor for each circuit can be selected by means of DSW setting.
DSW5#1:OFF;2#ON 	C1 : Average OU Sensor C2 : Average Aux Sensor	
DSW5#1:ON;2#OFF 	C1 : Average Aux Sensor C2 : Average OU Sensor	
DSW5#1:ON;2#ON 	C1 : Average Aux Sensor C2 : Average Aux Sensor	

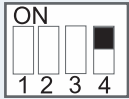
Code	Optional function description	Explanation
DSW5#4:ON 	Use max (T_{wo1}/T_{wo3}) for water control	Some installation needs big buffer tank and in combination with auxiliary heating (boiler, pellets, solar panels. Etc...), the control of the water can be done by external temperature sensor (T_{wo3}) to heat this buffer tank. Refer to Service Manual.

12.8.2 Optional functions by Unit controller (PC-ARFH2E)

12.8.2.1 Optional functions for Space Heating or Space Cooling

Optional function	Explanation
Floor screed drying function (Circuits 1 & 2)	This function is used exclusively for the process of drying screed that has been newly applied to floor heating system. The water temperature set-point follows a predetermined schedule upon activation of the floor screed drying function. For more information refer to Water control chapter.
Heating Auto ON/OFF	At higher outside temperatures it doesn't make sense to keep heating the building. The YUTAKI S System will switch the heating off when the daily average outdoor temperature of previously day rises above the Summer Switch Auto On/Off Activation Temperature. For more information refer to Service Manual.
Auto Heat-Cool	Only available for Cooling and Heating models and cooling mode enabled. By using auto summer switch off average, user can use auto heat cool mode. The end-user sets the desired operation mode on the user interface: Heating, Cooling or Automatic. When Automatic is selected, the change of the operation mode is based on: Averaged outdoor temperature: the operation mode will be changed in order to always be within range determined by the space heating OFF temperature for heating and the space cooling ON temperature for cooling. If the outdoor temperature drops, the operation mode switches to heating and vice versa. For more information refer to Service Manual.
Outdoor temperature average timer	The average timer corrects the influence of ambient temperature variations. The weather-dependent set point calculation is done on the average outdoor temperature. The outdoor temperature is averaged over the selected time period. For more information refer to Service Manual.

12.8.2.2 Optional functions for DHW

Optional function	Explanation
DHW anti-Legionella protection	A specific setting is available to protect the DHW system against Legionella, which raises up the DHW temperature over the normal DHW tank temperature setting (using the electric heater of the DHW tank and/or the heat pump) on a periodic basis. For more information refer to Service Manual.
DHW re-circulation	This function allows the activation of the water pump for the re-circulation of the hot water from the DHW tank by means of the heat pump. This function can also be used with the anti-legionella protection function. For more information refer to Service Manual.
DHW boost	With this function enabled, it is possible to request a heating up of the DHW when user requires an instantaneous delivery of DHW. For more information refer to Service Manual.
DHW Mode	DHW operation has 2 different modes, STANDARD and HIGH DEMAND : <ul style="list-style-type: none"> • STANDARD Mode: Behaves the same as Economic mode but it is used the lowest tank sensor to judge water temperature inside tank. This functionality ensure higher quantity of water already heated inside of tank and heating-up process are more frequent. • HIGH DEMAND Mode: The heating of the domestic hot water is started if differential is bigger than TDHWON. It will be started with water tank heater only unless water temperature in tank goes below Heat Pump starting temperature measured with the lowest sensor on tank. For more information refer to Service Manual.

12.8.2.3 Optional functions for Heat pump

Optional function	Explanation
Hydraulic separator combination	<p>In some cases, water pump of the YUTAKI unit is not sized for big heating installation (small water pump). In this case, a hydraulic separator or buffer tank and secondary water pump has to be used to ensure proper water pump dimensioning.</p> <p>The boiler is configured in parallel with the heat pump. A hydraulic separator or buffer tank has to be used to ensure proper hydraulic balancing. Additional Water pump (WP3) and water sensor (T_{wo3}) are needed for boiler combination control (automatic added when Boiler combination is enabled).</p> <p>For more information refer to Service Manual.</p>
Pumps setup	<p>This option allows to configure between 2 hydraulic schemes when hydraulic separator is used. Standard configuration forces WP3 to operate whenever there is demand from Circuit 2. On the other hand, Parallel configuration, allows to connect WP3 and WP2 to the buffer tank, and operation of WP3 is independent to the operation of WP2.</p> <p>For more information refer to Service Manual.</p>
Electrical heater or boiler emergency mode	<p>For the use of the electrical heater or boiler in case of outdoor unit fault, additional setting shall be applied into IU setting:</p> <p>Electrical heater emergency can be both automatic or manual switched ON by the user and the configuration must be done from the Unit controller</p> <p>For more information refer to Service Manual.</p>
Smart Grid ready	<p>This function can be used to block or limit the heat pump or increase demand due to electricity availability. Demand increase is configurable for heating and also for cooling operation.</p> <p>For more information refer to Service Manual.</p>
Fan coil management	<p>In case fan coil is selected as a Heating/cooling emitter, fan speeds can be controlled from Room thermostat and fan coil's fan speeds are controlled from YUTAKI optional outputs.</p>

12.8.2.4 Optional functions for Unit controller (PC-ARFH2E)

Optional function	Explanation
UTC Zone	UTC Zone: Europe spans 7 primary time zones (5 of them can be seen on the map in this article, while 2 other zones contain the European part of Kazakhstan and some very eastern territories of European Russia). Most of European countries use daylight saving time and switch to it at the same moment, which is 'harmonise' their summer time adjustment.
European summer time	When European summer time is activated, it should change the time when the country / UTC zone is doing it.
Holidays	Holidays function is only available for room thermostat view of PC-ARFH2E. Holidays let the user specify a date and hour for the Room Setting to be OFF with the configured setting.

12.8.3 Optional external input/output configuration signals

The system has 7 input and 4 output optional signals (+ 4 output signals when using accessory). The new YUTAKI series allow different ports to be configured for those I/O signals, as well.

The user can configure those input signal to perform different functions from the unit controller. This is briefly explained in the next tables:

Input signals and input ports

Code	Name	Port	Input
,1	Input 1	TB2 #13&14	230 V
,2	Input 2	TB2 #13&15	230 V
,3	Input 3	TB2 #16&17	230 V
,4	Input 4	TB2 #16&18	230 V
,5	Input 5	TB2 #16&19	230 V
,6	Input 6	TB2 #16&20	230 V
,7	Input 7	TB2 #16&21	230 V

Input functions (To be configured from the unit controller)

Function #	Input	Description
0	Deactivated	-
1	Demand ON/OFF	Send Demand ON or OFF Operation to Circuit 1 and Circuit 2.
2	Smart Act./SG Ready Input 1	This function must be used to block or limit the heat pump when restricted by Electric company. It allows an external Smart switch device to switch off or reduce consumption of the heat pump during time of peak electricity demand. In case of use of Smart Grid Ready application, this input is used as a digital input 2 and allows four different operating modes.
3	Swimming pool	When YUTAKI model is used to warm th swimming pool water, this input is used as a feedback for swimming pool water pump.
4	Solar	In case of combine YUTAKI with solar panels, this input is used as a feedback for solar station ready operation.
5	Operation mode	Cool/Heat must be changed by an input of an external contact signal. Contact signal is edge detection; Cool/Heat changeover by unit controller is also available.
6	DHW boost	With this function enabled, it is possible to request a heating up of the DHW when user requires an instantaneous delivery of DHW.
8	Demand ON/OFF C1	Send Demand ON or OFF Operation only to Circuit 1.
9	Demand ON/OFF C2	Send Demand ON or OFF Operation only to Circuit 2.
10	Forced heating	Forced Heating Demand by input of contact signal from outside.
11	Forced cooling	Forced Cooling Demand by input of contact signal from outside.
13	ECO mode C1 & C2	Water temperature setting for Circuit 1 and Circuit 2 it is reduced by ECO operation mode (Default 3°C) by input of contact signal from outside.
14	ECO mode C1	Water temperature setting for Circuit 1 it is reduced by ECO operation mode (Default 3°C) by input of contact signal from outside.
15	ECO mode C2	Water temperature setting for Circuit 2 it is reduced by ECO operation mode (Default 3°C) by input of contact signal from outside.
16	Force OFF	Force OFF operation for unit. RCS will continue as normally set but will show indication that operation is forbidden.
17	SG Ready Input 2	In case of want to use Smart Grid Ready application, this input is used as a digital input 2 and allow four different operating modes.

Output signals and output ports

Code	Name	Port	Output
o1	Output 1	TB2 #34 (N) & 35 (L)	230 V
o2	Output 2	TB2 #34 (N) & 36 (L)	230 V
o3	Output 3	TB2 #37&38	Free voltage signal
o4	Output 4	TB2 #39&40	Free voltage signal
o5	Output 5	PCN20 #1-2	12Vdc signal
o6	Output 6	PCN21 #1-2	12Vdc signal
o7	Output 7	PCN22 #1-2	12Vdc signal
o8	Output 8	PCN23 #1-2	12Vdc signal
o9	Output 9	PCN12 #1-2	230 V

Output functions (To be configured from the unit controller)

Function #	Output	Description
0	Deactivated	-
1	3WV SWP	In case of combine YUTAKI with swimming pool, this output is used to drive 3 way valve swimming pools.
2	WP3	In case of combine YUTAKI with boiler or hydraulic separator, this output is used to drive water pump 3.
3	Boiler combination	In case of combine YUTAKI with boiler, this output is used to switch ON it.
4	Solar pump	In case of combine YUTAKI with solar panel, this output is used to drive water pump station
5	Alarm signal	Output when an "Alarm Code" is received from Indoor Unit or outdoor unit.
6	Operation signal	Output in case that "Thermo-ON" signal in any condition.
7	Cooling signal	Output in case that "Thermo-ON" signal in Cooling operation.
8	Demand-ON signal circuit 1	Signal is enabled when circuit 1 is operating in Demand-ON.
9	Heating signal	Output in case that "Thermo-ON" signal in Heating operation.
10	DHW signal	Output in case that "Thermo-ON" signal in DHW operation.
11	Solar overheat	Output in case that solar temperature signal is active when solar overheat (only when solar combination status is total control).
12	Defrost	Output if the operation state of the outdoor unit when is defrosting.
13	DHW re-circulation pump	In case of re-circulation pump enabled for HSW tank.
14	Fan 1 Low speed	Output for fan coil speed.
15	Fan 1 Medium speed	Output for fan coil speed.
16	Fan 1 High speed	Output for fan coil speed.
17	Fan 2 Low speed	Output for fan coil speed.
18	Fan 2 Medium speed	Output for fan coil speed.
19	Fan 2 High speed	Output for fan coil speed.
20	Constant Heat	Output in high state whenever operation mode from Unit controller is in heating mode.
21	Constant cool	Output in high state whenever operation mode from Unit controller is in cooling mode.

12.9 Additional functions by accessory sensor

Hitachi offers to its users the option to add more functions to the inputs from signals coming from some specific sensors. The configuration for this purpose is explained below:

I/O Terminal name		Port for setting (Connector number)	Factory default setting		Input/Output type
I/O	Display		Setting contents	Function #	
Sensor 1	A1	CN26 #2	T _{wo3}	0	NTC
Sensor 2	A2	CN25 #1-2	Disabled	0	NTC
Sensor 3	A3	CN5 #1	Disabled	0	NTC

Function of sensors

Function #	Input	Description
0	Disabled	-
1	T _{wo3} sensor	T _{wo3} sensor is used when there is external heating source or useful to track better temperature when there is hydraulic separator or buffer tank.
2	Swimming pool	When combining YUTAKI with swimming pool, this sensor is used to read the temperature from the water of the swimming pool.
3	Solar panel sensor	When combining YUTAKI with solar panels, this sensor is used to read the temperature from the solar panel.
4	Zone 1 & 2 ambient sensor	If Aux1 and Aux2 sensors are both connected and enabled at the unit controller configuration, the detection of ambient temperature value is carried out by these sensors. The ambient temperature setting for each circuit is set from the unit controller or central platform. The temperature value detected by each sensor is applied to the corresponding circuit.
5	Zone 1 ambient sensor	If Aux1 and Aux2 sensors are both connected and enabled at the unit controller configuration, the detection of ambient temperature value is carried out by these sensors. The ambient temperature setting for each circuit is set from the unit controller or central platform. The temperature value detected by each sensor is applied to the circuit 1.
6	Zone 2 ambient sensor	If Aux1 and Aux2 sensors are both connected and enabled at the unit controller configuration, the detection of ambient temperature value is carried out by these sensors. The ambient temperature setting for each circuit is set from the unit controller or central platform. The temperature value detected by each sensor is applied to the circuit 2.
7	Second outdoor ambient	An outside temperature sensor can be directly connected to the controller in case the heat pump is located in a position not suitable for this measurement.



Hitachi certifies that our products have met EU consumer safety, health and environmental requirements.



ER-0198/1996



GA-1999/0044

Johnson Controls-Hitachi Air Conditioning Spain, S.A.U. is certified with:
ISO 9001 of AENOR, Spain for its Quality Management accordance with the standard.
ISO 14001 of AENOR Spain for its Environmental Management systems accordance with the standard.



JQA-1084



EC97J1107

Hitachi air conditioning products are manufactured according to:
ISO 9001 of JQA, Japan for its Quality Management accordance with the standard.
ISO 14001 of JACO, Japan for its Environmental Management accordance with the standard.

Cooling & Heating

Johnson Controls-Hitachi Air Conditioning Spain, S.A.U.
Ronda Shimizu, 1 - Políg. Ind. Can Torrella
08233 Vacarisses (Barcelona) Spain

© Copyright 2021 Johnson Controls-Hitachi Air Conditioning Spain, S.A.U. – All rights reserved.