

## TECHNICAL CATALOGUE

### MONO SPLIT

RAK-18RPE  
RAK-25RPE  
RAK-35RPE  
RAK-42RPE  
RAK-50RPE



RAC-18WPE  
RAC-25WPE  
RAC-35WPE



RAC-42WPE  
RAC-50WPE



# HITACHI

**Specifications in this catalogue are subject to change without prior notice in order for HITACHI to bring in the latest innovations to their customers**

**Whilst every effort is made to ensure that all dimensions and specifications are correct, any printers' error not rectified are outside the control of HITACHI, who cannot be held responsible for the same**

# CONTENTS

|   |           |
|---|-----------|
| <b>CONTENTS</b>   | <b>1</b>  |
| <b>1 SPECIFICATIONS</b>                                     | <b>2</b>  |
| 1.1. WALL TYPE (RAK-18RPE/25RPE/35RPE)                      | 2         |
| 1.2. WALL TYPE (RAK-42RPE/50RPE)                            | 3         |
| 1.3. WALL TYPE (RAC-18WPE/25WPE/35WPE)                      | 4         |
| 1.4. WALL TYPE (RAC-42WPE/50WPE)                            | 5         |
| <b>2 DIMENSIONAL DATA</b>                                   | <b>6</b>  |
| 2.1. WALL TYPE: RAK-18RPE/25RPE/35RPE/42RPE/50RPE           | 6         |
| 2.2. WALL TYPE: RAC-18WPE/25WPE/35WPE                       | 7         |
| 2.3. WALL TYPE: RAC-42WPE/50WPE                             | 8         |
| <b>3 CAPACITIES TABLE</b>                                   | <b>9</b>  |
| 3.1. CAPACITY CHARACTERISTIC CURVES                         | 9         |
| 3.1.1. RAK-18RPE/RAC-18WPE                                  | 9         |
| 3.1.2. RAK-25RPE/RAC-25WPE                                  | 10        |
| 3.1.3. RAK-35RPE/RAC-35WPE                                  | 10        |
| 3.1.4. RAK-42RPE/RAC-42WPE                                  | 11        |
| 3.1.5. RAK-50RPE/RAC-50WPE                                  | 11        |
| 3.2. CORRECTION FACTORS ACCORDING TO PIPING LENGTH          | 12        |
| 3.3. CORRECTION FACTORS ACCORDING TO DEFROSTING OPERATION   | 14        |
| <b>4 SOUND DATA</b>   | <b>15</b> |
| 4.1. RAC-18WPE  | 15        |
| 4.2. RAC-25WPE  | 16        |
| 4.3. RAC-35WPE  | 17        |
| 4.4. RAC-42WPE  | 18        |
| 4.5. RAC-50WPE  | 19        |
| <b>5 WORKING RANGE</b>                                      | <b>20</b> |
| 5.1. POWER SUPPLY   | 20        |
| 5.2. WORKING RANGE  | 20        |
| <b>6 ELECTRICAL DATA</b>                                    | <b>21</b> |
| 6.1. INDOOR UNIT  | 21        |
| 6.2. OUTDOOR UNIT   | 21        |
| <b>7 WIRING DIAGRAM</b>                                     | <b>22</b> |
| 7.1. RAK-18RPE/25RPE/35RPE/42RPE/50RPE                      | 22        |
| 7.2. RAC-18WPE/25WPE/35WPE                                  | 23        |
| 7.3. RAC-42WPE/50WPE  | 24        |
| <b>8 REFRIGERANT CYCLE</b>                                  | <b>25</b> |
| 8.1. WALL TYPE: RAK/C-18R/WPE,RAK/C-25R/WPE,RAK/C-35R/WPE   | 25        |
| 8.2. WALL TYPE: RAK/C-42R/WPE,RAK/C-50R/WPE                 | 25        |
| <b>9 CONTROL AND FUNCTION</b>                               | <b>26</b> |
| 9.1. WIRELESS REMOTE CONTROL FUNCTION                       | 26        |
| 9.2. AUTO CHANGEOVER  | 28        |
| 9.3. SHIFT VALUE  | 28        |
| 9.4. OPERATION LOCK   | 29        |
| 9.5. SETTING THE PREVENTION OF MUTUAL INTERFERENCE          | 29        |
| 9.6. INTERMITTENT FAN SPEED SETTING                         | 30        |
| 9.7. FAN SPEED SETTING IN THERMO OFF IN COOLING             | 31        |
| 9.8. ERROR CODE INFORMATION                                 | 32        |
| 9.9. ADDITIONAL FUNCTION VIA DIP-SWITCH SETTINGS            | 33        |
| 9.9.1. AUTO RESTART FUNCTION                                | 33        |
| 9.9.2. HEATING/COOLING ONLY MODE SELECTION                  | 33        |
| <b>10 OPTION LIST</b>                                       | <b>34</b> |
| 10.1. WIRED REMOTE CONTROL – SPX-RCDB                       | 34        |
| 10.1.1. SHIFT VALUE   | 34        |
| 10.1.2. ERROR CODE INFORMATION                              | 35        |
| 10.2. H-LINK ADAPTOR – PSC 6RAD                             | 37        |
| 10.2.1. SAFETY SUMMARY                                      | 37        |
| 10.2.2. INSTALLATION WORK                                   | 37        |
| 10.2.3. ELECTRICAL WIRING                                   | 38        |
| 10.2.4. DIP SWITCH SETTING                                  | 39        |
| 10.2.5. TEST RUN  | 40        |
| 10.3. DRY CONTACT (SPX-WDC3) APPLICATION (USING DIP SWITCH) | 41        |
| 10.4. DISTRIBUTOR – SPX-DST1                                | 43        |

# 1 SPECIFICATIONS

## 1.1. WALL TYPE (RAK-18RPE/25RPE/35RPE)

| INDOOR  | Unit              | RAK-18RPE                       | RAK-25RPE                       | RAK-35RPE                       |
|---|-------------------|---------------------------------|---------------------------------|---------------------------------|
| Nominal capacity adjustable                           |                   | no                              | no                              | no                              |
| Nominal Cooling capacity (min - max)                  | kW                | 2.00 (0.90 - 2.50)              | 2.50 (0.90 - 3.10)              | 3.50 (0.90- 4.00)               |
| Cooling sensible capacity                             | kW                | 1.94                            | 2.05                            | 2.42                            |
| Nominal Heating capacity (min - max)                  | kW                | 2.50 (0.90 - 3.20)              | 3.40 (0.90- 4.40)               | 4.20 (0.90- 5.00)               |
| Noise level cooling (sound pressure) (SL / L / M / H) | dB(A)             | 21/24/33/37                     | 22/24/33/40                     | 25/26/36/43                     |
| Noise level heating (sound pressure) (SL / L / M / H) | dB(A)             | 19/22/33/38                     | 20/23/34/41                     | 26/27/36/44                     |
| Noise level (sound power)                             | dB(A)             | 51                              | 54                              | 57                              |
| Air flow cooling mode (SL / L / M / H)                | m <sup>3</sup> /h | 312 / 350 / 400 / 440           | 333 / 370 / 430 / 510           | 353 / 420 / 485 / 680           |
| Air flow heating mode (SL / L / M / H)                | m <sup>3</sup> /h | 312 / 350 / 420 / 480           | 333 / 400 / 500 / 570           | 363 / 480 / 570/ 780            |
| Fan Motor   | W                 | 30                              | 30                              | 30                              |
| Dehumidification                                      | l/h               | 1.2                             | 1.4                             | 1.6                             |
| Dimensions (H x W x D)                                | mm                | 280 x 780 x 230                 | 280 x 780 x 230                 | 280 x 780 x 230                 |
| Weight  | kg                | 8.5                             | 8.5                             | 8.5                             |
| Colour  |                   | Star White (N9.3)               | Star White (N9.3)               | Star White (N9.3)               |
| Condensate Drain                                      | mm                | φ 16                            | φ 16                            | φ 16                            |
| Running current (C/H)                                 | A                 | 1.09-4.39/1.09-4.22             | 1.09-5.61/1.09-6.52             | 1.09-6.35/1.09-7.39             |
| Power supply  |                   | 220-230V                        | 220-230V                        | 220-230V                        |
| Cable section (interconnection)                       | mm <sup>2</sup>   | 1.50x 3+EARTH/-                 | 1.50x 3+EARTH/-                 | 1.50x 3+EARTH/-                 |
| Piping diameter (Liq / Gas)                           | Inch              | 1/4" / 3/8"                     | 1/4" / 3/8"                     | 1/4" / 3/8"                     |
| Drain diameter (ext)                                  | mm                | φ 16                            | φ 16                            | φ 16                            |
| Remote control (standard/optional)                    |                   | RAR-6NE1/SPX-RCDB               | RAR-6NE1/SPX-RCDB               | RAR-6NE1/SPX-RCDB               |
| <b>Filter</b>   |                   |                                 |                                 |                                 |
| ACL Filter  |                   | activated carbon                | activated carbon                | activated carbon                |
| ACL part name   |                   | SPX-CFH25                       | SPX-CFH25                       | SPX-CFH25                       |
| Pre-filter(Standard/Optional )                        |                   | WASHABLE/<br>Stainless-SPX-SPF8 | WASHABLE/<br>Stainless-SPX-SPF8 | WASHABLE/<br>Stainless-SPX-SPF8 |

### NOTE:

1. The nominal cooling and heating capacity is the combined capacity of the HITACHI standard split system, and are based on the ISO 5151.

| Operation Conditions  |    | Cooling | Heating |
|---|----|---------|---------|
| Indoor Air Inlet Temperature  | dB | 27.0 °C | 20.0 °C |
|   | WB | 19.0 °C | 15.0 °C |
| Outdoor Air Inlet Temperature   | dB | 35.0 °C | 7.0 °C  |
|   | WB | 24.0 °C | 6.0 °C  |
| Piping Length: 5.0 meters; Piping Lift: 0 meter<br>dB: Dry Bulb; WB: Wet Bulb |    |         |         |

2. The Sound Pressure Level is based on the following conditions:

- 0.8 meter beneath indoor height center
- 1 meter from Discharge grille

The above data was measured in an anechoic chamber. Please take into consideration reflected sound of your specific site

## 1.2. WALL TYPE (RAK-42RPE/50RPE)

| INDOOR   | Unit              | RAK-42RPE                       | RAK-50RPE                       |
|--|-------------------|---------------------------------|---------------------------------|
| Nominal capacity adjustable                              |                   | no                              | no                              |
| Nominal Cooling capacity (min - max)                     | kW                | 4.20(1.70- 5.00)                | 5.00 (1.90- 5.20)               |
| Cooling sensible capacity                                | kW                | 3.25                            | 3.43                            |
| Nominal Heating capacity (min - max)                     | kW                | 5.40(1.70- 6.00)                | 6.00 (2.20- 7.30)               |
| Noise level cooling (sound pressure)<br>(SL / L / M / H) | dB(A)             | 25/28/39/46                     | 25/28/39/46                     |
| Noise level heating (sound pressure)<br>(SL / L / M / H) | dB(A)             | 27/31/39/46                     | 27/31/39/46                     |
| Noise level (sound power)                                | dB(A)             | 60                              | 60                              |
| Air flow cooling mode (SL / L / M / H)                   | m <sup>3</sup> /h | 353 / 410 / 540 / 720           | 353 / 410 / 540 / 750           |
| Air flow heating mode (SL / L / M / H)                   | m <sup>3</sup> /h | 380 / 500 / 610 / 800           | 380 / 500 / 610 / 820           |
| Fan Motor  | W                 | 30                              | 30                              |
| Dehumidification   | l/h               | 1.8                             | 2.0                             |
| Dimensions (H x W x D)                                   | mm                | 280 x 780 x 230                 | 280 x 780 x 230                 |
| Weight   | kg                | 8.5                             | 8.5                             |
| Colour   |                   | Star White (N9.3)               | Star White (N9.3)               |
| Condensate Drain   | mm                | φ 16                            | φ 16                            |
| Running current (C/H)                                    | A                 | 1.30-7.39/2.17-8.70             | 1.30-8.70/2.17-11.96            |
| Power supply   |                   | 220-230V                        | 220-230V                        |
| Cable section (interconnection )                         | mm <sup>2</sup>   | 2.50x 3+EARTH/-                 | 2.50x 3+EARTH/-                 |
| Piping diameter (Liq / Gas)                              | Inch              | 1/4" / 1/2"                     | 1/4" / 1/2"                     |
| Drain diameter (ext)                                     | mm                | φ 16                            | φ 16                            |
| Remote control (standard/optional)                       |                   | RAR-6NE1/SPX-RCDB               | RAR-6NE1/SPX-RCDB               |
| <b>Filter</b>  |                   |                                 |                                 |
| ACL Filter   |                   | activated carbon                | activated carbon                |
| ACL part name  |                   | SPX-CFH25                       | SPX-CFH25                       |
| Pre-filter(Standard/Optional )                           |                   | WASHABLE/<br>Stainless-SPX-SPF8 | WASHABLE/<br>Stainless-SPX-SPF8 |

### NOTE:

1. The nominal cooling and heating capacity is the combined capacity of the HITACHI standard split system, and are based on the ISO 5151.

| Operation Conditions  |    | Cooling | Heating |
|---|----|---------|---------|
| Indoor Air Inlet Temperature  | dB | 27.0 °C | 20.0 °C |
|   | WB | 19.0 °C | 15.0 °C |
| Outdoor Air Inlet Temperature   | dB | 35.0 °C | 7.0 °C  |
|   | WB | 24.0 °C | 6.0 °C  |
| Piping Length: 5.0 meters; Piping Lift: 0 meter<br>dB: Dry Bulb; WB: Wet Bulb |    |         |         |

2. The Sound Pressure Level is based on the following conditions:

- 0.8 meter beneath indoor height center
- 1 meter from Discharge grille

The above data was measured in an anechoic chamber. Please take into consideration reflected sound of your specific site

### 1.3. WALL TYPE (RAC-18WPE/25WPE/35WPE)

| OUTDOOR   |                   | RAC-18WPE           | RAC-25WPE             | RAC-35WPE             |                       |
|---|-------------------|---------------------|-----------------------|-----------------------|-----------------------|
| Nominal Cooling capacity (min - max)              | kW                | 2.00 (0.90 - 2.50)  | 2.50 (0.90 - 3.10)    | 3.50 (0.90- 4.00)     |                       |
| Nominal Heating capacity (min - max)              | kW                | 2.50 (0.90 - 3.20)  | 3.40 (0.90- 4.40)     | 4.20 (0.90- 5.00)     |                       |
| Nominal cooling power input (min - max)           | kW                | 0.419(0.25 - 1.01)  | 0.549(0.25 - 1.29)    | 0.941(0.25 - 1.46)    |                       |
| Nominal heating power input (min - max)           | kW                | 0.519(0.25 - 0.97)  | 0.733(0.25 - 1.50)    | 1.000(0.25 - 1.70)    |                       |
| EER / COP   |                   | 4.77/4.82           | 4.55/4.64             | 3.72/4.2              |                       |
| SEER / SCOP                                       |                   | 8.50/4.90           | 8.50/4.90             | 7.80/4.90             |                       |
| Energy class (SEER/SCOP)                          |                   | A+++/A++            | A+++/A++              | A++/A++               |                       |
| Noise level cooling (sound pressure)              | dB(A)             | 44                  | 46                    | 48                    |                       |
| Noise level heating (sound pressure)              | dB(A)             | 45                  | 47                    | 49                    |                       |
| Noise level (sound power)                         | dB(A)             | 58                  | 60                    | 61                    |                       |
| Air flow (Cooling / Heating)                      | m <sup>3</sup> /h | 1860 / 1620         | 1860 / 1620           | 1920 / 1620           |                       |
| Dimensions (H x W x D)                            | mm                | 548× 750× 288       | 548× 750× 288         | 548× 750× 288         |                       |
| Weight  | kg                | 32.5                | 32.5                  | 32.5                  |                       |
| Colour (Munsell Code)                             |                   | Beige (5Y7/2)       | Beige (5Y7/2)         | Beige (5Y7/2)         |                       |
| Power supply                                      | V/Ph/Hz           | 230V / 1Ph / 50Hz   | 230V / 1Ph / 50Hz     | 230V / 1Ph / 50Hz     |                       |
| Recommended fuse size                             | A                 | 15                  | 15                    | 15                    |                       |
| Starting current(C/H)                             | A                 | 2.46/2.93           | 3.08/3.87             | 4.81/5.11             |                       |
| Running current (C/H)                             | A                 | 1.09-4.39/1.09-4.22 | 1.09-5.61/1.09-6.52   | 1.09-6.35/1.09-7.39   |                       |
| Cable section (power)                             | mm <sup>2</sup>   | 1.50x 2+EARTH       | 1.50x 2+EARTH         | 1.50x 2+EARTH         |                       |
| Cable section (Interconnection)                   | mm <sup>2</sup>   | 1.50x 3+EARTH       | 1.50x 3+EARTH         | 1.50x 3+EARTH         |                       |
| Piping diameter (Liq / Gas)                       | Inch              | 1/4" / 3/8"         | 1/4" / 3/8"           | 1/4" / 3/8"           |                       |
| Minimum piping length                             | m                 | 3                   | 3                     | 3                     |                       |
| Maximum piping length / height difference         | m                 | 20 / 10             | 20 / 10               | 20 / 10               |                       |
| Current quantity of refrigerant / Chargeless      | kg                | 0.870               | 0.870                 | 0.870                 |                       |
| Chargeless length / Additional refrigerant charge | m / g/m           | 20/-                | 20/-                  | 20/-                  |                       |
| Working range (cooling / heating)                 | °C                | -10°C~43°C/-15~21°C | -10°C~43°C/-15~21°C   | -10°C~43°C/-15~21°C   |                       |
| Refrigerant                                       |                   | R32                 | R32                   | R32                   |                       |
| Condenser Fan                                     |                   | Propeller Fan       | Propeller Fan         | Propeller Fan         |                       |
| Compressor  | Type              |                     | ROTARY                | ROTARY                | ROTARY                |
|   | Oil Charge        | mL                  | 320±20                | 320±20                | 320±20                |
|   | Oil Type          |                     | ACS-68R or equivalent | ACS-68R or equivalent | ACS-68R or equivalent |
|   | Coil resistance   | Ω                   | 2.167 at 20°C         | 2.167 at 20°C         | 2.167 at 20°C         |
|   | Quantity          |                     | 1                     | 1                     | 1                     |

**NOTE:**

1. The Sound Pressure Level is based on the following conditions:

- 1 meter from the unit front surface and 1 meter from floor level

The above data was measured in an anechoic chamber. Please take into consideration reflected sound of your specific site

**1.4. WALL TYPE (RAC-42WPE/50WPE)**

| OUTDOOR   |                   | RAC-42WPE           | RAC-50WPE             |
|---|-------------------|---------------------|-----------------------|
| Nominal Cooling capacity (min - max)              | kW                | 4.20 (1.70- 5.00)   | 5.00 (1.90- 5.20)     |
| Nominal Heating capacity (min - max)              | kW                | 5.40 (1.70- 6.00)   | 6.00 (2.20- 7.30)     |
| Nominal cooling power input (min - max)           | kW                | 1.120(0.30 - 1.70)  | 1.471(0.30 - 2.10)    |
| Nominal heating power input (min - max)           | kW                | 1.317(0.50 - 2.10)  | 1.558(0.50 - 2.75)    |
| EER / COP   |                   | 3.75/4.1            | 3.40/3.85             |
| SEER / SCOP                                       |                   | 7.50/4.60           | 7.35/4.60             |
| Energy class (SEER/SCOP)                          |                   | A++/A++             | A++/A++               |
| Noise level cooling (sound pressure)              | dB(A)             | 49                  | 49                    |
| Noise level heating (sound pressure)              | dB(A)             | 50                  | 50                    |
| Noise level (sound power)                         | dB(A)             | 63                  | 63                    |
| Air flow (Cooling / Heating)                      | m <sup>3</sup> /h | 2160 / 2160         | 2160 / 2160           |
| Dimensions (H x W x D)                            | mm                | 600x792x299         | 600x792x299           |
| Weight  | kg                | 39                  | 39                    |
| Colour (Munsell Code)                             |                   | Beige (5Y7/2)       | Beige (5Y7/2)         |
| Power supply                                      | V/Ph/Hz           | 230V / 1Ph / 50Hz   | 230V / 1Ph / 50Hz     |
| Recommended fuse size                             | A                 | 25                  | 25                    |
| Starting current(C/H)                             | A                 | 5.10/5.99           | 6.69/7.09             |
| Running current (C/H)                             | A                 | 1.30-7.39/2.17-8.70 | 1.30-8.70/2.17-11.96  |
| Cable section (power)                             | mm <sup>2</sup>   | 2.50x 2+EARTH       | 2.50x 2+EARTH         |
| Cable section (Interconnection)                   | mm <sup>2</sup>   | 2.50x 3+EARTH       | 2.50x 3+EARTH         |
| Piping diameter (Liq / Gas)                       | Inch              | 1/4" / 1/2"         | 1/4" / 1/2"           |
| Minimum piping length                             | m                 | 3                   | 3                     |
| Maximum piping length / height difference         | m                 | 20 / 10             | 20 / 10               |
| Current quantity of refrigerant / Chargeless      | kg                | 1.050               | 1.050                 |
| Chargeless length / Additional refrigerant charge | m / g/m           | 20/-                | 20/-                  |
| Working range (cooling / heating)                 | °C                | -10°C~43°C/-15~21°C | -10°C~43°C/-15~21°C   |
| Refrigerant                                       |                   | R32                 | R32                   |
| Condenser Fan                                     |                   | Propeller Fan       | Propeller Fan         |
| Compressor  | Type              | 2 Cylinder Rotary   | 2 Cylinder Rotary     |
|   | Oil Charge        | mL                  | 480±20                |
|   | Oil Type          |                     | ACS-68R or equivalent |
|   | Coil resistance   | Ω                   | 1.354 at 20°C         |
|   | Quantity          |                     | 1                     |

**NOTE:**

1. The Sound Pressure Level is based on the following conditions:

- 1 meter from the unit front surface and 1 meter from floor level

The above data was measured in an anechoic chamber. Please take into consideration reflected sound of your specific site

## 2 DIMENSIONAL DATA

### 2.1. WALL TYPE :RAK-18RPE/25RPE/35RPE/42RPE/50RPE

Unit : mm

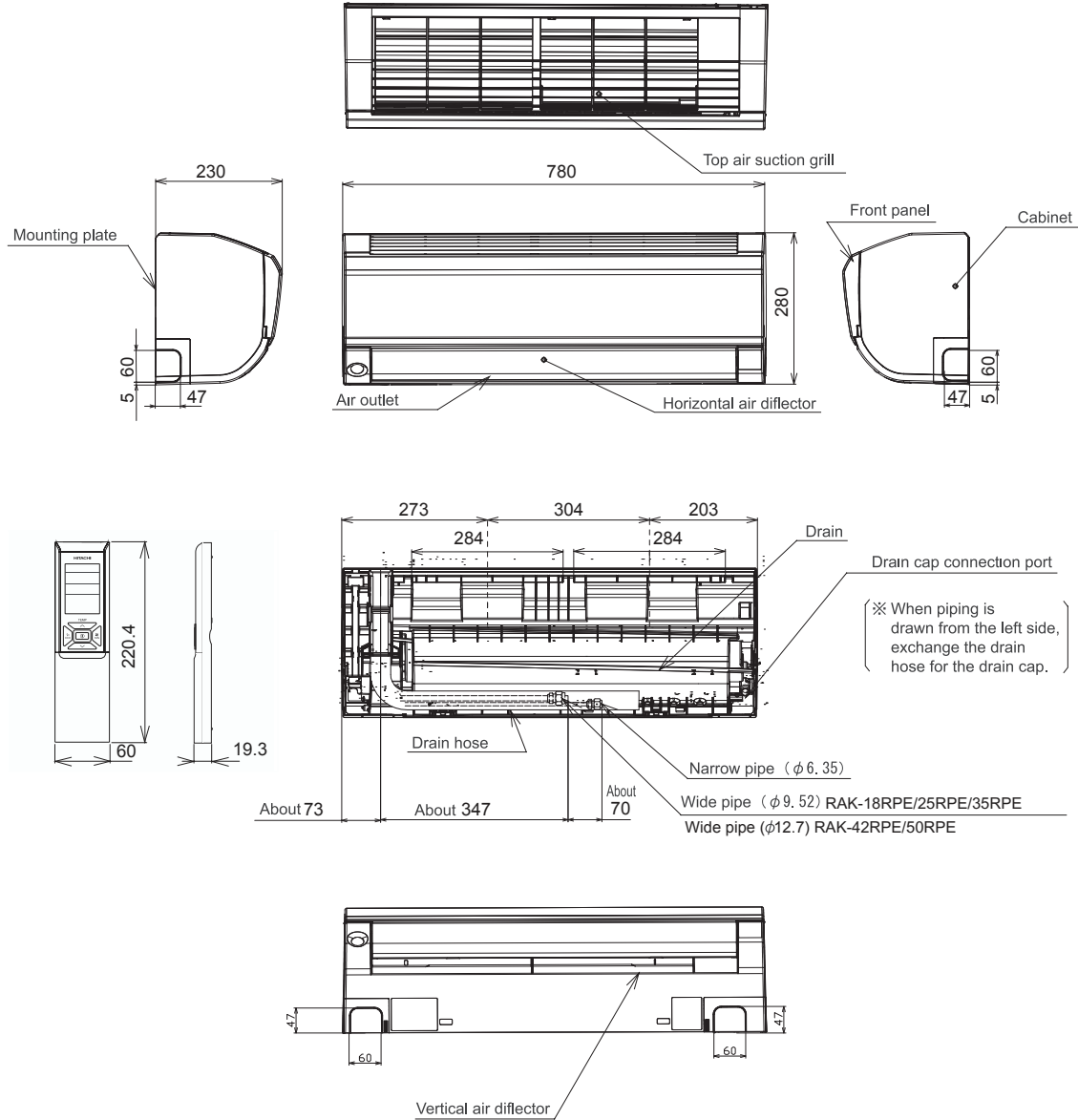



2.2. WALL TYPE :RAC-18WPE/25WPE/35WPE

Unit : mm

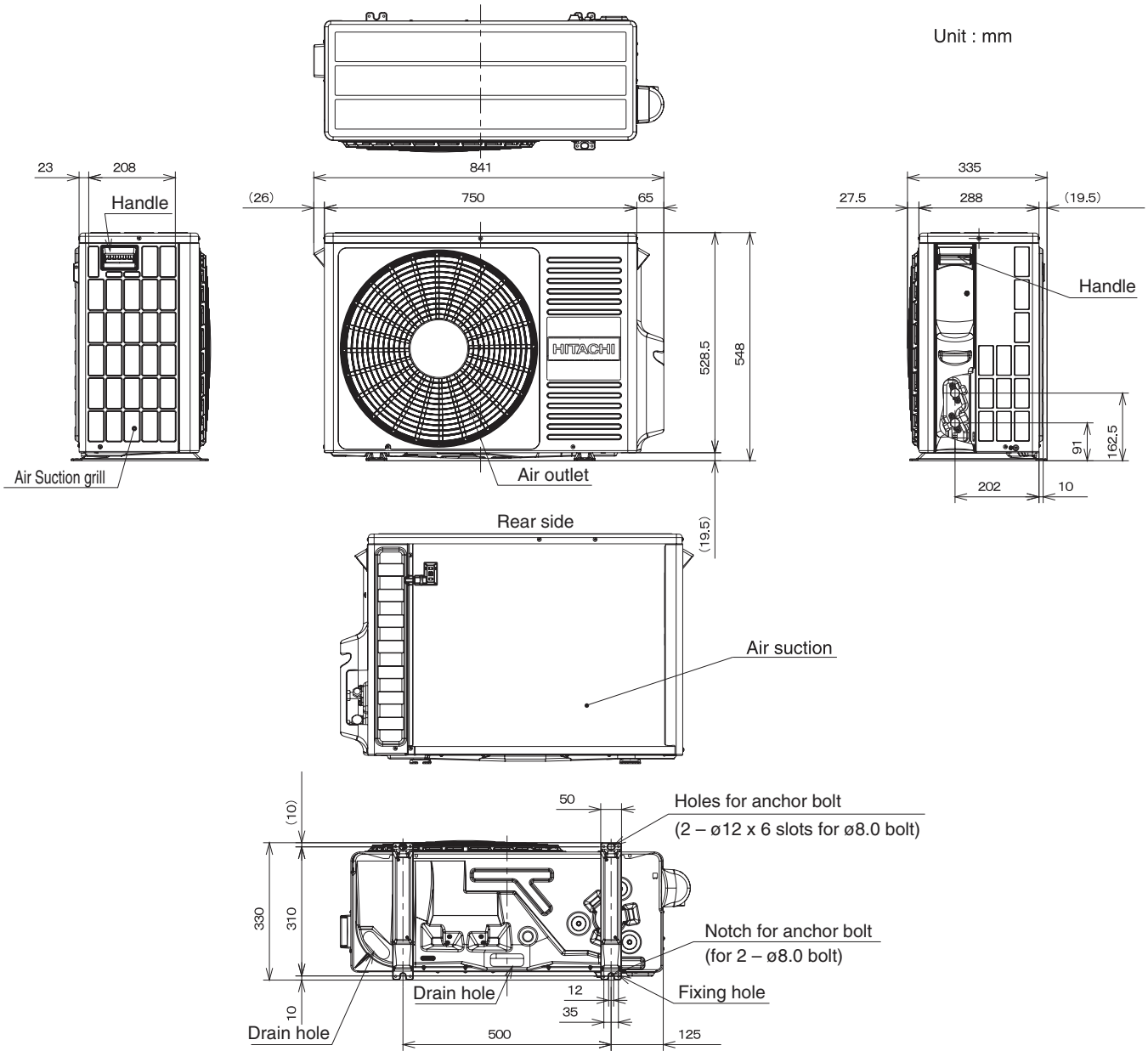

## 2.3. WALL TYPE:RAC-42WPE/50WPE

Unit : mm

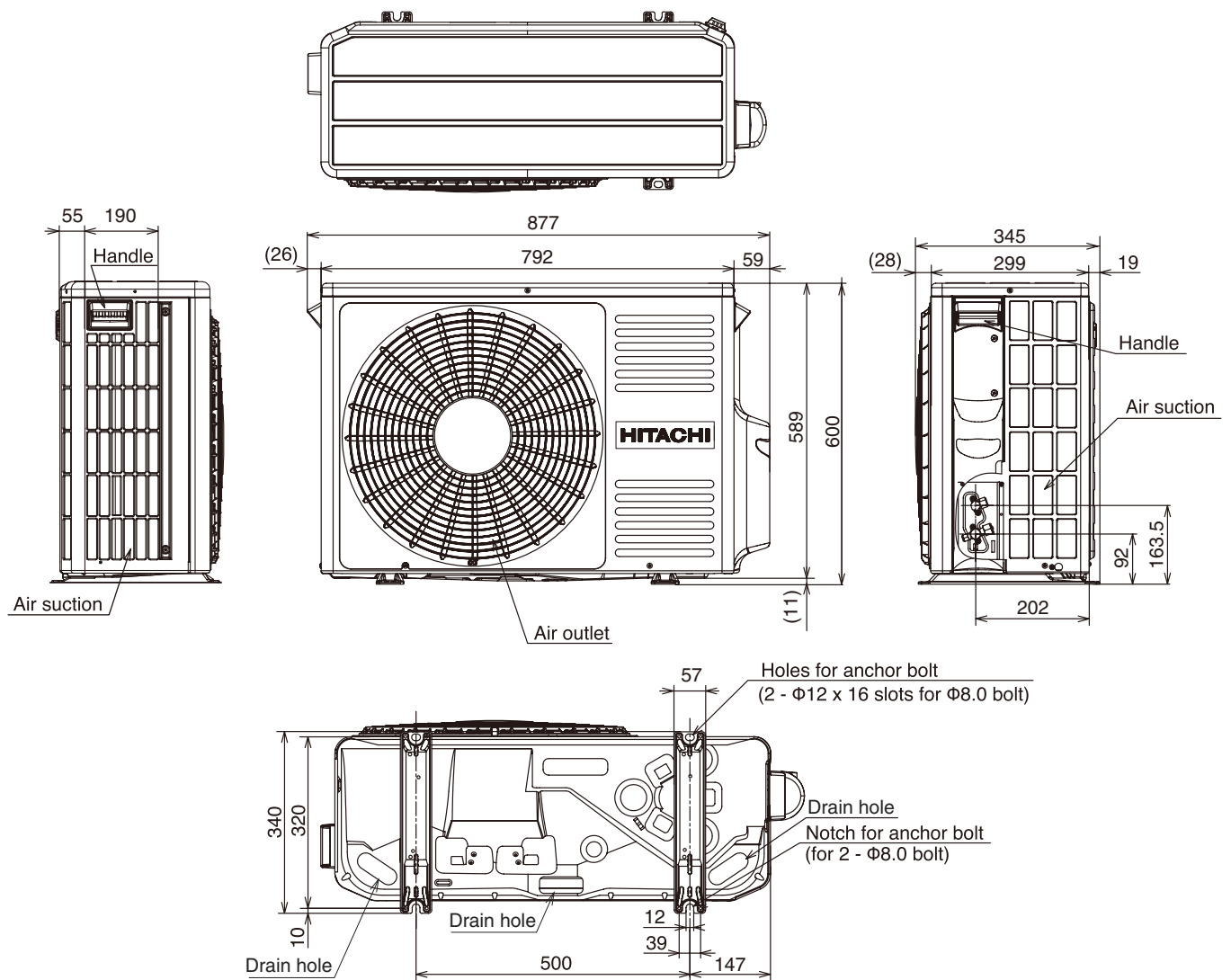

## 3 CAPACITIES TABLE

### 3.1. CAPACITY CHARACTERISTIC CURVES

The following charts show the characteristics of outdoor unit capacity, which corresponds with the operating ambient temperature of outdoor unit.

Conditions:

- ① Pipe length / height difference : 5m / 0m  
 ② Indoor fan speed at High mode

③ Capacity loss due to white frost and defrost operation is not included.

#### 3.1.1. RAK-18RPE/RAC-18WPE

### COOLING [50Hz, 230V]

| INDOOR |     | OUTDOOR TEMPERATURE (°CDW) |      |     |      |      |     |      |      |     |      |      |     |      |      |     |      |      |     |      |      |     |
|--------|-----|----------------------------|------|-----|------|------|-----|------|------|-----|------|------|-----|------|------|-----|------|------|-----|------|------|-----|
| EWB    | EDB | -10                        |      |     | 21   |      |     | 27   |      |     | 32   |      |     | 35   |      |     | 40   |      |     | 43   |      |     |
| °C     | °C  | TC                         | SHC  | PI  | TC   | SHC  | PI  | TC   | SHC  | PI  | TC   | SHC  | PI  | TC   | SHC  | PI  | TC   | SHC  | PI  | TC   | SHC  | PI  |
| 12.0   | 18  | 1581                       | 1441 | 238 | 1790 | 1922 | 282 | 1657 | 1774 | 332 | 1640 | 1765 | 385 | 1580 | 1688 | 402 | 1480 | 1591 | 432 | 1420 | 1513 | 448 |
| 14.0   | 20  | 1581                       | 1441 | 238 | 1924 | 1922 | 282 | 1790 | 1792 | 336 | 1760 | 1765 | 390 | 1700 | 1707 | 406 | 1580 | 1591 | 436 | 1520 | 1533 | 457 |
| 16.0   | 22  | 1581                       | 1534 | 241 | 2057 | 1922 | 286 | 1905 | 1792 | 340 | 1880 | 1765 | 394 | 1820 | 1707 | 415 | 1700 | 1591 | 444 | 1640 | 1533 | 461 |
| 18.0   | 25  | 1695                       | 1644 | 245 | 2190 | 2088 | 289 | 2019 | 1940 | 344 | 2000 | 1921 | 398 | 1920 | 1843 | 415 | 1800 | 1727 | 448 | 1720 | 1649 | 465 |
| 19.0   | 27  | 1752                       | 1700 | 249 | 2267 | 2199 | 293 | 2095 | 2032 | 348 | 2080 | 2018 | 402 | 2000 | 1940 | 419 | 1880 | 1824 | 448 | 1800 | 1746 | 465 |
| 22.0   | 30  | 1943                       | 1681 | 249 | 2514 | 2180 | 293 | 2324 | 2014 | 348 | 2300 | 1998 | 406 | 2220 | 1921 | 423 | 2000 | 1862 | 465 | 1860 | 1824 | 490 |
| 24.0   | 32  | 2076                       | 1681 | 252 | 2686 | 2180 | 297 | 2476 | 2014 | 352 | 2460 | 1998 | 406 | 2360 | 1921 | 427 | 2080 | 1901 | 478 | 1900 | 1882 | 507 |

### HEATING [50Hz, 230V]

| INDOOR |      | OUTDOOR TEMPERATURE (°CDW) |     |      |     |     |      |     |     |      |     |     |      |     |     |      |     |     |      |     |     |      |     |     |
|--------|------|----------------------------|-----|------|-----|-----|------|-----|-----|------|-----|-----|------|-----|-----|------|-----|-----|------|-----|-----|------|-----|-----|
| EDB    | -15  | -10                        |     |      | -7  |     |      | -5  |     |      | 0   |     |      | 7   |     |      | 10  |     |      | 15  |     |      |     |     |
| °C     | TC   | SHC                        | PI  | TC   | SHC | PI  | TC   | SHC | PI  | TC   | SHC | PI  | TC   | SHC | PI  | TC   | SHC | PI  | TC   | SHC | PI  | TC   | SHC | PI  |
| 16     | 2025 |                            | 808 | 2400 |     | 877 | 2632 |     | 912 | 2622 |     | 848 | 2590 |     | 700 | 2529 |     | 473 | 2753 |     | 512 | 3146 |     | 575 |
| 18     | 2013 |                            | 814 | 2388 |     | 883 | 2616 |     | 921 | 2604 |     | 860 | 2570 |     | 712 | 2514 |     | 496 | 2739 |     | 536 | 3123 |     | 602 |
| 20     | 2000 |                            | 820 | 2375 |     | 889 | 2600 |     | 930 | 2586 |     | 871 | 2550 |     | 725 | 2500 |     | 519 | 2725 |     | 560 | 3100 |     | 629 |
| 22     | 1988 |                            | 826 | 2363 |     | 895 | 2584 |     | 939 | 2568 |     | 883 | 2530 |     | 737 | 2486 |     | 542 | 2711 |     | 584 | 3077 |     | 656 |
| 24     | 1975 |                            | 832 | 2350 |     | 900 | 2568 |     | 948 | 2549 |     | 894 | 2510 |     | 749 | 2471 |     | 565 | 2698 |     | 608 | 3054 |     | 683 |

EWB : Evaporator Wet Bulb temperature (°C)

EDB : Evaporator Dry Bulb temperature (°C)

(°CDB) : Outdoor Unit Inlet Air Dry Bulb Temperature (°C)

TC : Total Capacity (W)

SHC : Sensible Heating Capacity (W)

PI : Power Input

## 3.1.2. RAK-25RPE/RAC-25WPE

## COOLING [50Hz, 230V]

| INDOOR |     | OUTDOOR TEMPERATURE (°CDW) |      |     |      |      |     |      |      |     |      |      |     |      |      |     |      |      |     |      |      |     |
|--------|-----|----------------------------|------|-----|------|------|-----|------|------|-----|------|------|-----|------|------|-----|------|------|-----|------|------|-----|
| EWB    | EDB | -10                        |      |     | 21   |      |     | 27   |      |     | 32   |      |     | 35   |      |     | 40   |      |     | 43   |      |     |
| °C     | °C  | TC                         | SHC  | PI  | TC   | SHC  | PI  | TC   | SHC  | PI  | TC   | SHC  | PI  | TC   | SHC  | PI  | TC   | SHC  | PI  | TC   | SHC  | PI  |
| 12.0   | 18  | 1976                       | 1523 | 311 | 2238 | 2030 | 370 | 2071 | 1874 | 436 | 2050 | 1866 | 505 | 1975 | 1784 | 527 | 1850 | 1681 | 565 | 1775 | 1599 | 587 |
| 14.0   | 20  | 1976                       | 1523 | 311 | 2405 | 2030 | 370 | 2238 | 1894 | 441 | 2200 | 1866 | 511 | 2125 | 1804 | 533 | 1975 | 1681 | 571 | 1900 | 1620 | 598 |
| 16.0   | 22  | 1976                       | 1620 | 316 | 2571 | 2030 | 374 | 2381 | 1894 | 446 | 2350 | 1866 | 516 | 2275 | 1804 | 544 | 2125 | 1681 | 582 | 2050 | 1620 | 604 |
| 18.0   | 25  | 2119                       | 1738 | 321 | 2738 | 2206 | 379 | 2524 | 2050 | 451 | 2500 | 2030 | 522 | 2400 | 1948 | 544 | 2250 | 1825 | 587 | 2150 | 1743 | 609 |
| 19.0   | 27  | 2190                       | 1796 | 326 | 2833 | 2323 | 384 | 2619 | 2148 | 456 | 2600 | 2132 | 527 | 2500 | 2050 | 549 | 2350 | 1927 | 587 | 2250 | 1845 | 609 |
| 22.0   | 30  | 2429                       | 1777 | 326 | 3143 | 2304 | 384 | 2905 | 2128 | 456 | 2875 | 2112 | 533 | 2775 | 2030 | 554 | 2500 | 1968 | 609 | 2325 | 1927 | 642 |
| 24.0   | 32  | 2595                       | 1777 | 331 | 3357 | 2304 | 389 | 3095 | 2128 | 461 | 3075 | 2112 | 533 | 2950 | 2030 | 560 | 2600 | 2009 | 626 | 2375 | 1989 | 664 |

## HEATING [50Hz, 230V]

| INDOOR |      | OUTDOOR TEMPERATURE (°CDW) |      |      |     |      |      |     |      |      |     |      |      |     |      |      |     |     |      |     |     |      |     |      |
|--------|------|----------------------------|------|------|-----|------|------|-----|------|------|-----|------|------|-----|------|------|-----|-----|------|-----|-----|------|-----|------|
| EDB    | -15  | -10                        |      |      | -7  |      |      | -5  |      |      | 0   |      |      | 7   |      |      | 10  |     |      | 15  |     |      |     |      |
| °C     | TC   | SHC                        | PI   | TC   | SHC | PI   | TC   | SHC | PI   | TC   | SHC | PI   | TC   | SHC | PI   | TC   | SHC | PI  | TC   | SHC | PI  | TC   | SHC | PI   |
| 16     | 2534 |                            | 992  | 3159 |     | 1111 | 3543 |     | 1172 | 3535 |     | 1099 | 3504 |     | 929  | 3439 |     | 664 | 3812 |     | 731 | 4463 |     | 841  |
| 18     | 2517 |                            | 1001 | 3142 |     | 1120 | 3521 |     | 1186 | 3510 |     | 1116 | 3477 |     | 948  | 3420 |     | 698 | 3794 |     | 768 | 4431 |     | 882  |
| 20     | 2500 |                            | 1010 | 3125 |     | 1129 | 3500 |     | 1200 | 3486 |     | 1133 | 3450 |     | 967  | 3400 |     | 733 | 3775 |     | 804 | 4400 |     | 923  |
| 22     | 2483 |                            | 1019 | 3108 |     | 1138 | 3479 |     | 1214 | 3461 |     | 1151 | 3423 |     | 985  | 3380 |     | 768 | 3756 |     | 841 | 4369 |     | 964  |
| 24     | 2466 |                            | 1028 | 3091 |     | 1146 | 3457 |     | 1228 | 3436 |     | 1168 | 3396 |     | 1004 | 3361 |     | 802 | 3738 |     | 877 | 4337 |     | 1005 |

EWB : Evaporator Wet Bulb temperature (°C)

EDB : Evaporator Dry Bulb temperature (°C)

(°CDB) : Outdoor Unit Inlet Air Dry Bulb Temperature (°C)

TC : Total Capacity (W)

SHC : Sensible Heating Capacity (W)

PI : Power Input

## 3.1.3. RAK-35RPE/RAC-35WPE

## COOLING [50Hz, 230V]

| INDOOR |     | OUTDOOR TEMPERATURE (°CDW) |      |     |      |      |     |      |      |     |      |      |     |      |      |     |      |      |      |      |      |      |    |     |    |
|--------|-----|----------------------------|------|-----|------|------|-----|------|------|-----|------|------|-----|------|------|-----|------|------|------|------|------|------|----|-----|----|
| EWB    | EDB | -10                        |      |     | 21   |      |     | 27   |      |     | 32   |      |     | 35   |      |     | 40   |      |      | 43   |      |      |    |     |    |
| °C     | °C  | TC                         | SHC  | PI  | TC   | SHC  | PI  | TC   | SHC  | PI  | TC   | SHC  | PI  | TC   | SHC  | PI  | TC   | SHC  | PI   | TC   | SHC  | PI   | TC | SHC | PI |
| 12.0   | 18  | 2767                       | 1798 | 533 | 3133 | 2397 | 633 | 2900 | 2213 | 747 | 2870 | 2202 | 866 | 2765 | 2105 | 903 | 2590 | 1984 | 969  | 2485 | 1888 | 1007 |    |     |    |
| 14.0   | 20  | 2767                       | 1798 | 533 | 3367 | 2397 | 633 | 3133 | 2236 | 755 | 3080 | 2202 | 875 | 2975 | 2130 | 913 | 2765 | 1984 | 979  | 2660 | 1912 | 1026 |    |     |    |
| 16.0   | 22  | 2767                       | 1913 | 542 | 3600 | 2397 | 642 | 3333 | 2236 | 764 | 3290 | 2202 | 885 | 3185 | 2130 | 932 | 2975 | 1984 | 997  | 2870 | 1912 | 1035 |    |     |    |
| 18.0   | 25  | 2967                       | 2051 | 550 | 3833 | 2604 | 650 | 3533 | 2420 | 773 | 3500 | 2396 | 894 | 3360 | 2299 | 932 | 3150 | 2154 | 1007 | 3010 | 2057 | 1045 |    |     |    |
| 19.0   | 27  | 3067                       | 2120 | 558 | 3967 | 2743 | 658 | 3667 | 2535 | 782 | 3640 | 2517 | 903 | 3500 | 2420 | 941 | 3290 | 2275 | 1007 | 3150 | 2178 | 1045 |    |     |    |
| 22.0   | 30  | 3400                       | 2097 | 558 | 4400 | 2720 | 658 | 4067 | 2512 | 782 | 4025 | 2493 | 913 | 3885 | 2396 | 950 | 3500 | 2323 | 1045 | 3255 | 2275 | 1101 |    |     |    |
| 24.0   | 32  | 3633                       | 2097 | 567 | 4700 | 2720 | 667 | 4333 | 2512 | 790 | 4305 | 2493 | 913 | 4130 | 2396 | 960 | 3640 | 2372 | 1073 | 3325 | 2347 | 1139 |    |     |    |

## HEATING [50Hz, 230V]

| INDOOR |      | OUTDOOR TEMPERATURE (°CDW) |      |      |     |      |      |     |      |      |     |      |      |     |      |      |     |      |      |     |      |      |     |      |
|--------|------|----------------------------|------|------|-----|------|------|-----|------|------|-----|------|------|-----|------|------|-----|------|------|-----|------|------|-----|------|
| EDB    | -15  | -10                        |      |      | -7  |      |      | -5  |      |      | 0   |      |      | 7   |      |      | 10  |      |      | 15  |      |      |     |      |
| °C     | TC   | SHC                        | PI   | TC   | SHC | PI   | TC   | SHC | PI   | TC   | SHC | PI   | TC   | SHC | PI   | TC   | SHC | PI   | TC   | SHC | PI   | TC   | SHC | PI   |
| 16     | 3042 |                            | 1098 | 3636 |     | 1254 | 4003 |     | 1335 | 4047 |     | 1274 | 4142 |     | 1138 | 4248 |     | 914  | 4602 |     | 1002 | 5228 |     | 1148 |
| 18     | 3021 |                            | 1109 | 3615 |     | 1265 | 3977 |     | 1353 | 4016 |     | 1295 | 4109 |     | 1162 | 4224 |     | 957  | 4579 |     | 1048 | 5189 |     | 1199 |
| 20     | 3000 |                            | 1120 | 3594 |     | 1276 | 3950 |     | 1370 | 3986 |     | 1317 | 4075 |     | 1185 | 4200 |     | 1000 | 4556 |     | 1094 | 5150 |     | 1250 |
| 22     | 2979 |                            | 1131 | 3573 |     | 1287 | 3923 |     | 1387 | 3955 |     | 1339 | 4041 |     | 1208 | 4176 |     | 1043 | 4533 |     | 1139 | 5111 |     | 1301 |
| 24     | 2958 |                            | 1142 | 3552 |     | 1298 | 3897 |     | 1405 | 3925 |     | 1361 | 4008 |     | 1232 | 4152 |     | 1086 | 4510 |     | 1185 | 5072 |     | 1352 |

EWB : Evaporator Wet Bulb temperature (°C)

EDB : Evaporator Dry Bulb temperature (°C)

(°CDB) : Outdoor Unit Inlet Air Dry Bulb Temperature (°C)

TC : Total Capacity (W)

SHC : Sensible Heating Capacity (W)

PI : Power Input

## 3.1.4. RAK-42RPE/RAC-42WPE

## COOLING [50Hz, 230V]

| INDOOR |     | OUTDOOR TEMPERATURE (°CDW) |      |     |      |      |     |      |      |     |      |      |      |      |      |      |      |      |      |      |      |      |
|--------|-----|----------------------------|------|-----|------|------|-----|------|------|-----|------|------|------|------|------|------|------|------|------|------|------|------|
| EWB    | EDB | -10                        |      |     | 21   |      |     | 27   |      |     | 32   |      |      | 35   |      |      | 40   |      |      | 43   |      |      |
| °C     | °C  | TC                         | SHC  | PI  | TC   | SHC  | PI  | TC   | SHC  | PI  | TC   | SHC  | PI   | TC   | SHC  | PI   | TC   | SHC  | PI   | TC   | SHC  | PI   |
| 12.0   | 18  | 3320                       | 2414 | 635 | 3760 | 3219 | 754 | 3480 | 2971 | 889 | 3444 | 2958 | 1030 | 3318 | 2828 | 1075 | 3108 | 2665 | 1154 | 2982 | 2535 | 1198 |
| 14.0   | 20  | 3320                       | 2414 | 635 | 4040 | 3219 | 754 | 3760 | 3002 | 899 | 3696 | 2958 | 1042 | 3570 | 2860 | 1086 | 3318 | 2665 | 1165 | 3192 | 2568 | 1221 |
| 16.0   | 22  | 3320                       | 2569 | 645 | 4320 | 3219 | 764 | 4000 | 3002 | 909 | 3948 | 2958 | 1053 | 3822 | 2860 | 1109 | 3570 | 2665 | 1187 | 3444 | 2568 | 1232 |
| 18.0   | 25  | 3560                       | 2755 | 655 | 4600 | 3498 | 774 | 4240 | 3250 | 920 | 4200 | 3218 | 1064 | 4032 | 3088 | 1109 | 3780 | 2893 | 1198 | 3612 | 2763 | 1243 |
| 19.0   | 27  | 3680                       | 2848 | 665 | 4760 | 3683 | 784 | 4400 | 3405 | 930 | 4368 | 3380 | 1075 | 4200 | 3250 | 1120 | 3948 | 3055 | 1198 | 3780 | 2925 | 1243 |
| 22.0   | 30  | 4080                       | 2817 | 665 | 5280 | 3652 | 784 | 4880 | 3374 | 930 | 4830 | 3348 | 1086 | 4662 | 3218 | 1131 | 4200 | 3120 | 1243 | 3906 | 3055 | 1310 |
| 24.0   | 32  | 4360                       | 2817 | 675 | 5640 | 3652 | 794 | 5200 | 3374 | 941 | 5166 | 3348 | 1086 | 4956 | 3218 | 1142 | 4368 | 3185 | 1277 | 3990 | 3153 | 1355 |

## HEATING [50Hz, 230V]

| INDOOR |      | OUTDOOR TEMPERATURE (°CDW) |      |      |     |      |      |     |      |      |     |      |      |     |      |      |     |      |      |     |      |      |     |      |
|--------|------|----------------------------|------|------|-----|------|------|-----|------|------|-----|------|------|-----|------|------|-----|------|------|-----|------|------|-----|------|
| EDB    | -15  | -10                        |      |      | -7  |      |      | -5  |      |      | 0   |      |      | 7   |      |      | 10  |      |      | 15  |      |      |     |      |
| °C     | TC   | SHC                        | PI   | TC   | SHC | PI   | TC   | SHC | PI   | TC   | SHC | PI   | TC   | SHC | PI   | TC   | SHC | PI   | TC   | SHC | PI   | TC   | SHC | PI   |
| 16     | 3754 |                            | 1604 | 4254 |     | 1754 | 4568 |     | 1828 | 4707 |     | 1739 | 5036 |     | 1538 | 5462 |     | 1214 | 5759 |     | 1298 | 6300 |     | 1435 |
| 18     | 3727 |                            | 1617 | 4227 |     | 1767 | 4534 |     | 1849 | 4668 |     | 1765 | 4993 |     | 1566 | 5431 |     | 1265 | 5730 |     | 1352 | 6250 |     | 1496 |
| 20     | 3700 |                            | 1630 | 4200 |     | 1780 | 4500 |     | 1870 | 4629 |     | 1791 | 4950 |     | 1594 | 5400 |     | 1317 | 5700 |     | 1407 | 6200 |     | 1557 |
| 22     | 3673 |                            | 1643 | 4173 |     | 1793 | 4466 |     | 1891 | 4589 |     | 1817 | 4907 |     | 1621 | 5369 |     | 1369 | 5670 |     | 1462 | 6150 |     | 1618 |
| 24     | 3646 |                            | 1656 | 4146 |     | 1806 | 4432 |     | 1912 | 4550 |     | 1843 | 4864 |     | 1649 | 5338 |     | 1420 | 5641 |     | 1516 | 6100 |     | 1679 |

EWB : Evaporator Wet Bulb temperature (°C)

EDB : Evaporator Dry Bulb temperature (°C)

(°CDB) : Outdoor Unit Inlet Air Dry Bulb Temperature (°C)

TC : Total Capacity (W)

SHC : Sensible Heating Capacity (W)

PI : Power Input

## 3.1.5. RAK-50RPE/RAC-50WPE

## COOLING [50Hz, 230V]

| INDOOR |     | OUTDOOR TEMPERATURE (°CDW) |      |     |      |      |      |      |      |      |      |      |      |      |      |      |      |      |      |      |      |      |    |     |    |
|--------|-----|----------------------------|------|-----|------|------|------|------|------|------|------|------|------|------|------|------|------|------|------|------|------|------|----|-----|----|
| EWB    | EDB | -10                        |      |     | 21   |      |      | 27   |      |      | 32   |      |      | 35   |      |      | 40   |      |      | 43   |      |      |    |     |    |
| °C     | °C  | TC                         | SHC  | PI  | TC   | SHC  | PI   | TC   | SHC  | PI   | TC   | SHC  | PI   | TC   | SHC  | PI   | TC   | SHC  | PI   | TC   | SHC  | PI   | TC | SHC | PI |
| 12.0   | 18  | 3952                       | 2548 | 834 | 4476 | 3397 | 990  | 4143 | 3136 | 1167 | 4100 | 3121 | 1353 | 3950 | 2984 | 1412 | 3700 | 2813 | 1515 | 3550 | 2675 | 1574 |    |     |    |
| 14.0   | 20  | 3952                       | 2548 | 834 | 4810 | 3397 | 990  | 4476 | 3169 | 1181 | 4400 | 3121 | 1368 | 4250 | 3018 | 1427 | 3950 | 2813 | 1530 | 3800 | 2710 | 1603 |    |     |    |
| 16.0   | 22  | 3952                       | 2711 | 847 | 5143 | 3397 | 1003 | 4762 | 3169 | 1194 | 4700 | 3121 | 1383 | 4550 | 3018 | 1456 | 4250 | 2813 | 1559 | 4100 | 2710 | 1618 |    |     |    |
| 18.0   | 25  | 4238                       | 2907 | 860 | 5476 | 3691 | 1016 | 5048 | 3430 | 1208 | 5000 | 3396 | 1397 | 4800 | 3259 | 1456 | 4500 | 3053 | 1574 | 4300 | 2916 | 1633 |    |     |    |
| 19.0   | 27  | 4381                       | 3005 | 873 | 5667 | 3887 | 1029 | 5238 | 3593 | 1222 | 5200 | 3567 | 1412 | 5000 | 3430 | 1471 | 4700 | 3224 | 1574 | 4500 | 3087 | 1633 |    |     |    |
| 22.0   | 30  | 4857                       | 2973 | 873 | 6286 | 3855 | 1029 | 5810 | 3561 | 1222 | 5750 | 3533 | 1427 | 5550 | 3396 | 1486 | 5000 | 3293 | 1633 | 4650 | 3224 | 1721 |    |     |    |
| 24.0   | 32  | 5190                       | 2973 | 886 | 6714 | 3855 | 1042 | 6190 | 3561 | 1236 | 6150 | 3533 | 1427 | 5900 | 3396 | 1500 | 5200 | 3361 | 1677 | 4750 | 3327 | 1780 |    |     |    |

## HEATING [50Hz, 230V]

| INDOOR |      | OUTDOOR TEMPERATURE (°CDW) |      |      |     |      |      |     |      |      |     |      |      |     |      |      |     |      |      |     |      |      |     |      |
|--------|------|----------------------------|------|------|-----|------|------|-----|------|------|-----|------|------|-----|------|------|-----|------|------|-----|------|------|-----|------|
| EDB    | -15  | -10                        |      |      | -7  |      |      | -5  |      |      | 0   |      |      | 7   |      |      | 10  |      |      | 15  |      |      |     |      |
| °C     | TC   | SHC                        | PI   | TC   | SHC | PI   | TC   | SHC | PI   | TC   | SHC | PI   | TC   | SHC | PI   | TC   | SHC | PI   | TC   | SHC | PI   | TC   | SHC | PI   |
| 16     | 4060 |                            | 1767 | 4873 |     | 1979 | 5376 |     | 2087 | 5487 |     | 1991 | 5746 |     | 1778 | 6069 |     | 1428 | 6554 |     | 1548 | 7411 |     | 1744 |
| 18     | 4030 |                            | 1783 | 4843 |     | 1996 | 5338 |     | 2114 | 5444 |     | 2024 | 5698 |     | 1814 | 6035 |     | 1493 | 6521 |     | 1617 | 7356 |     | 1821 |
| 20     | 4000 |                            | 1800 | 4813 |     | 2013 | 5300 |     | 2140 | 5400 |     | 2057 | 5650 |     | 1849 | 6000 |     | 1558 | 6488 |     | 1686 | 7300 |     | 1898 |
| 22     | 3970 |                            | 1817 | 4783 |     | 2029 | 5262 |     | 2166 | 5357 |     | 2090 | 5602 |     | 1884 | 5966 |     | 1623 | 6455 |     | 1754 | 7245 |     | 1975 |
| 24     | 3940 |                            | 1833 | 4753 |     | 2046 | 5224 |     | 2193 | 5313 |     | 2122 | 5554 |     | 1920 | 5931 |     | 1688 | 6422 |     | 1823 | 7189 |     | 2052 |

EWB : Evaporator Wet Bulb temperature (°C)

EDB : Evaporator Dry Bulb temperature (°C)

(°CDB) : Outdoor Unit Inlet Air Dry Bulb Temperature (°C)

TC : Total Capacity (W)

SHC : Sensible Heating Capacity (W)

PI : Power Input

### 3.2. CORRECTION FACTORS ACCORDING TO PIPING LENGTH

Correction Factor for **Cooling Capacity** according to Piping Length

The cooling capacity should be corrected according to the following formula:

$$CCA = CC \times F$$

CCA: Actual Corrected Cooling Capacity (kcal/h)

CC: Cooling Capacity in the Performance Table (kcal/h)

F: Correction Factor Based on the Equivalent Piping Length

Correction Factor for **Heating Capacity** according to Piping Length

The heating capacity should be corrected according to the following formula:

$$HCA = HC \times F$$

HCA: Actual Corrected Heating Capacity (kcal/h)

HC: Heating Capacity in the Performance Table (kcal/h)

F: Correction Factor Based on the Equivalent Piping Length

The correction factors are shown in the following figure.

Equivalent Piping Length for:

- One 90° Elbow is 0.5m.
- One 180° Curve is 1.5m.

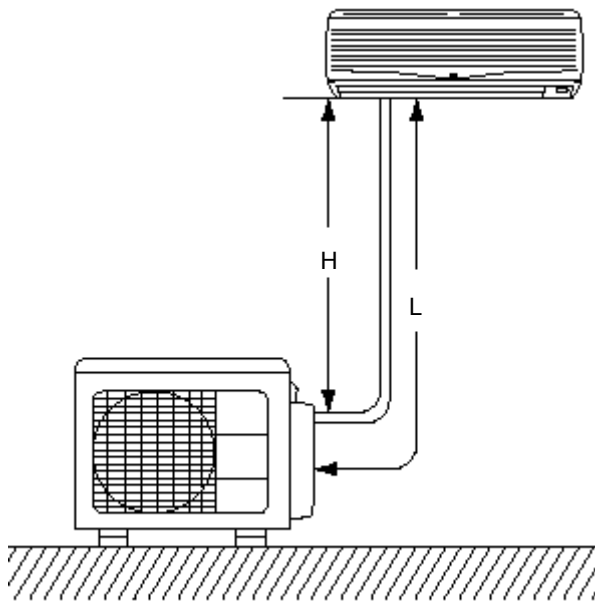

H: Vertical Distance Between Indoor Unit and Outdoor Units in Meters

L: Actual One-Way Piping Length Between Indoor Unit and Outdoor Unit in Meters

EL: Equivalent Total Distance Between Indoor Unit and Outdoor Unit in Meters (Equivalent One-Way Piping Length)

Models : RAK-18RPE、RAK-25RPE、RAK-35RPE  
RAC-18WPE、RAC-25WPE、RAC-35WPE

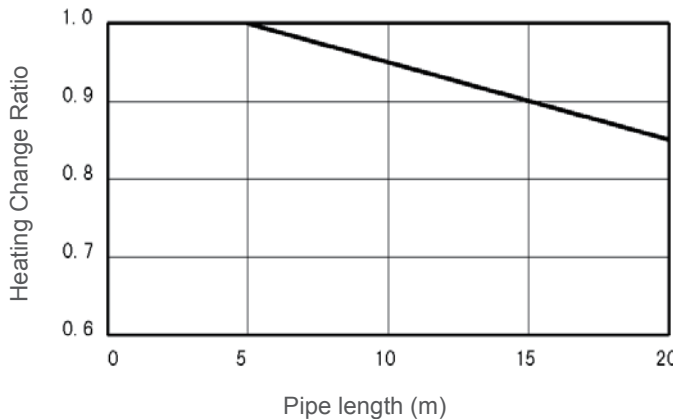
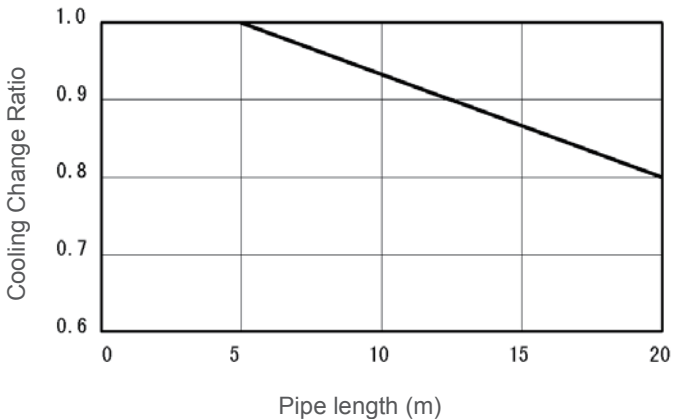

Models : RAK-42RPE、RAK-50RPE  
RAC-42WPE、RAC-50WPE

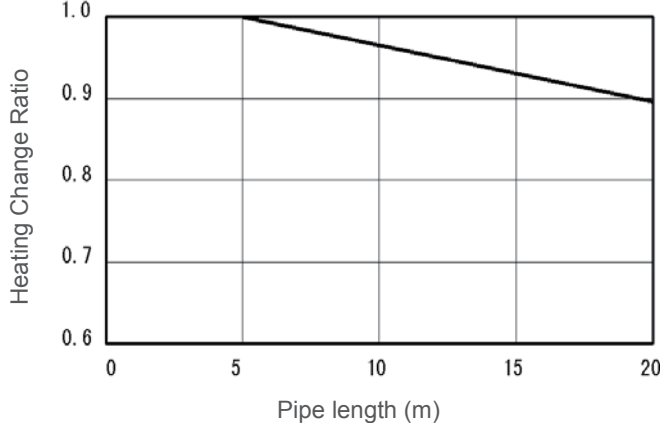
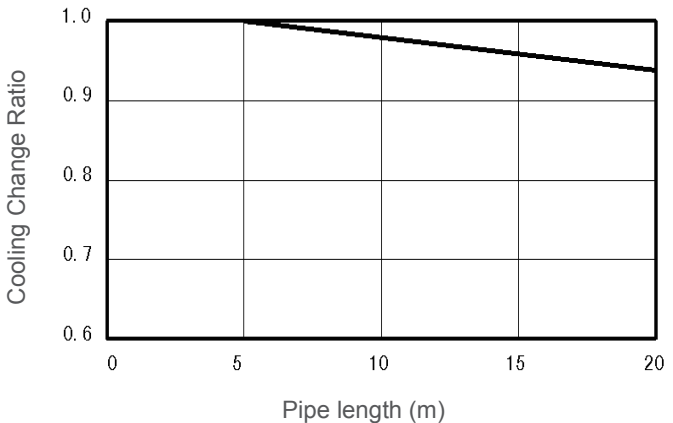

### 3.3. CORRECTION FACTORS ACCORDING TO DEFROSTING OPERATION

The heating capacity in the preceding paragraph, excludes the condition of the frost or the defrosting operation period. In consideration of the frost or the defrosting operation, the heating capacity is corrected by the equation below.

$$\text{Corrected heating capacity} = \text{Defrost Correction factor} \times \text{unit capacity}$$

|  |      |      |      |      |      |     |     |     |
|--|------|------|------|------|------|-----|-----|-----|
| OUTDOOR TEMPERATURE (°CDB)               | -15  | -10  | -7   | -5   | 0    | 7   | 10  | 15  |
| Correction factor (humidity rate 85% RH) | 0.95 | 0.95 | 0.89 | 0.85 | 0.81 | 1.0 | 1.0 | 1.0 |

Correction Factor

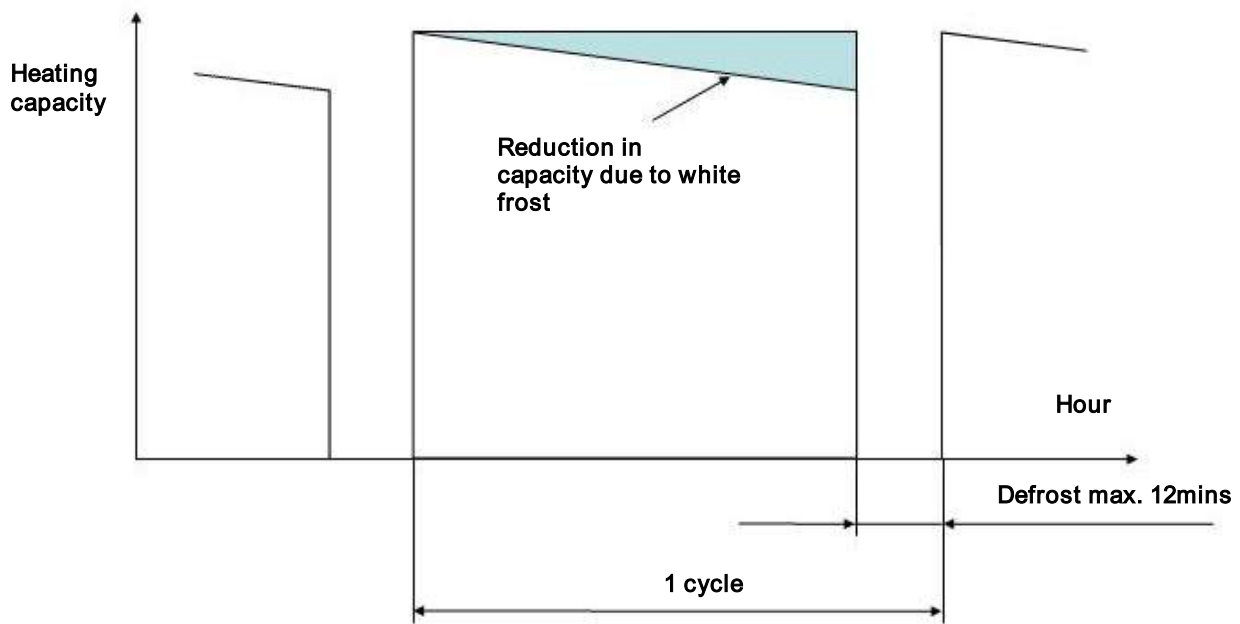

**NOTE:**

The correction factor is not valid for special conditions such as snowfall or operation in a transitional period.



## 4 SOUND DATA

### 4.1. RAC-18WPE

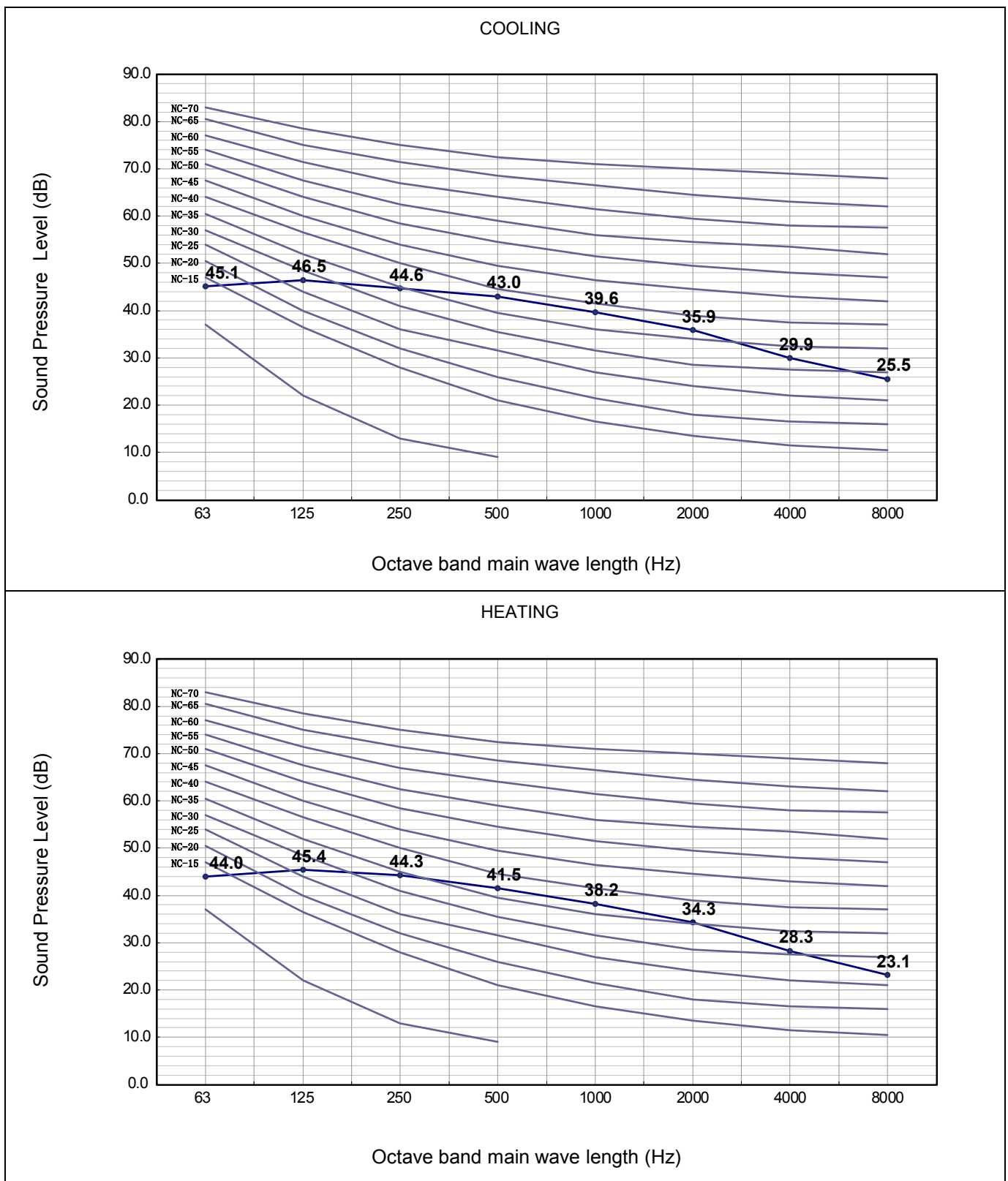

The Sound Pressure Level is based on the following conditions:

- 1 meter from the unit front surface and 1 meter from floor level

The above data was measured in an anechoic chamber. Please take into consideration reflected sound of your specific site

4.2. RAC-25WPE

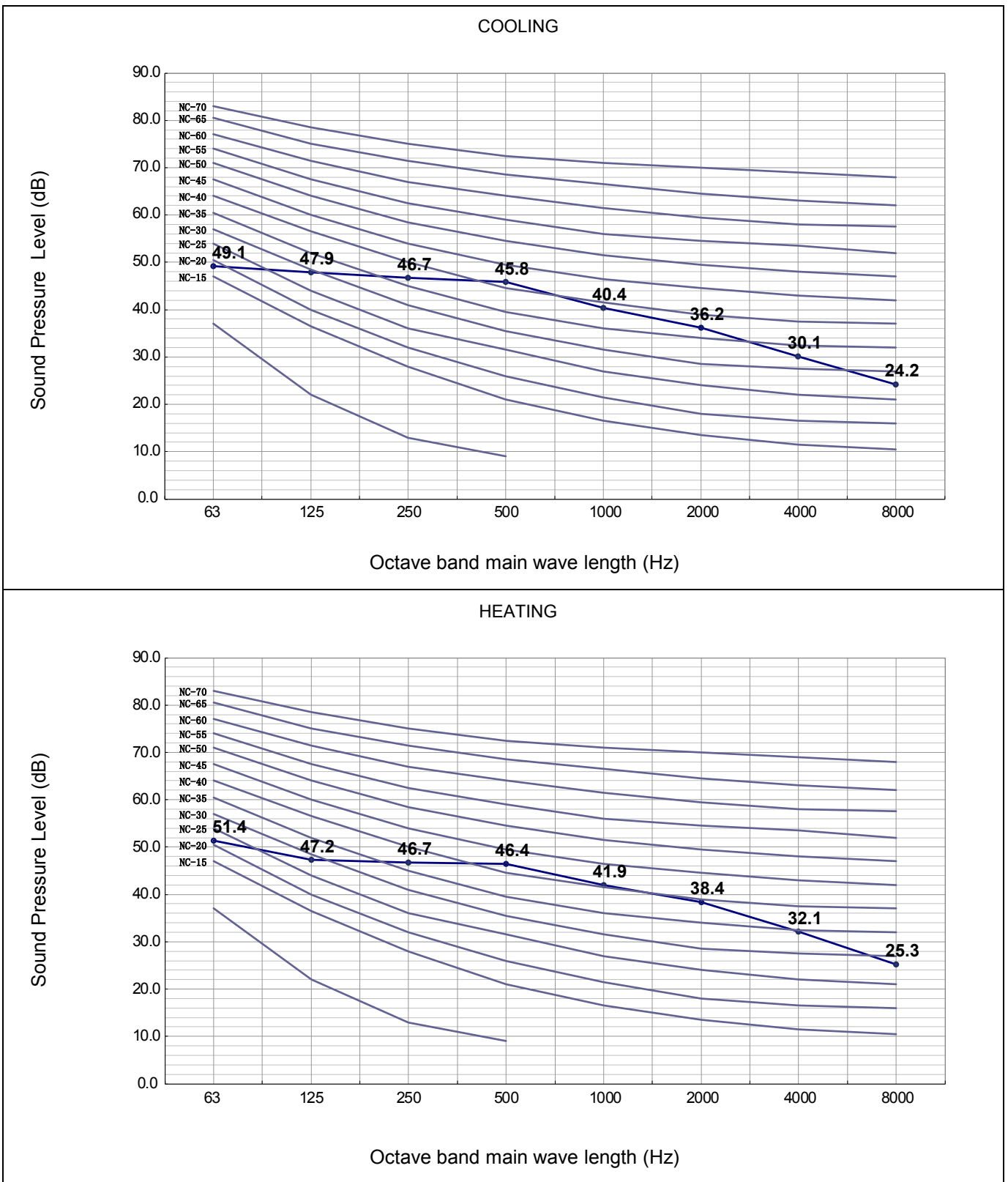

The Sound Pressure Level is based on the following conditions:

- 1 meter from the unit front surface and 1 meter from floor level

The above data was measured in an anechoic chamber. Please take into consideration reflected sound of your specific site

### 4.3. RAC-35WPE

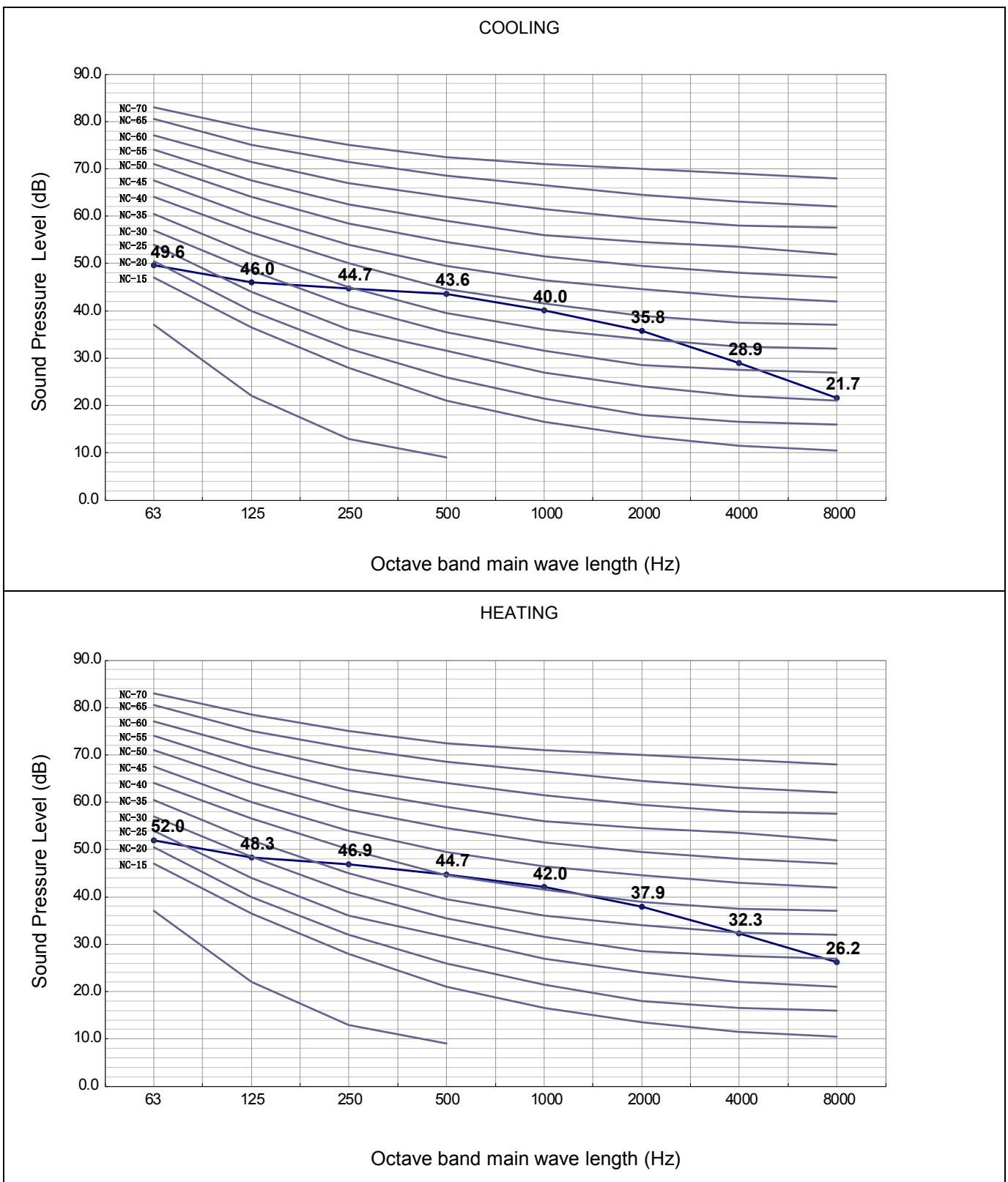

The Sound Pressure Level is based on the following conditions:

- 1 meter from the unit front surface and 1 meter from floor level

The above data was measured in an anechoic chamber. Please take into consideration reflected sound of your specific site

4.4. RAC-42WPE

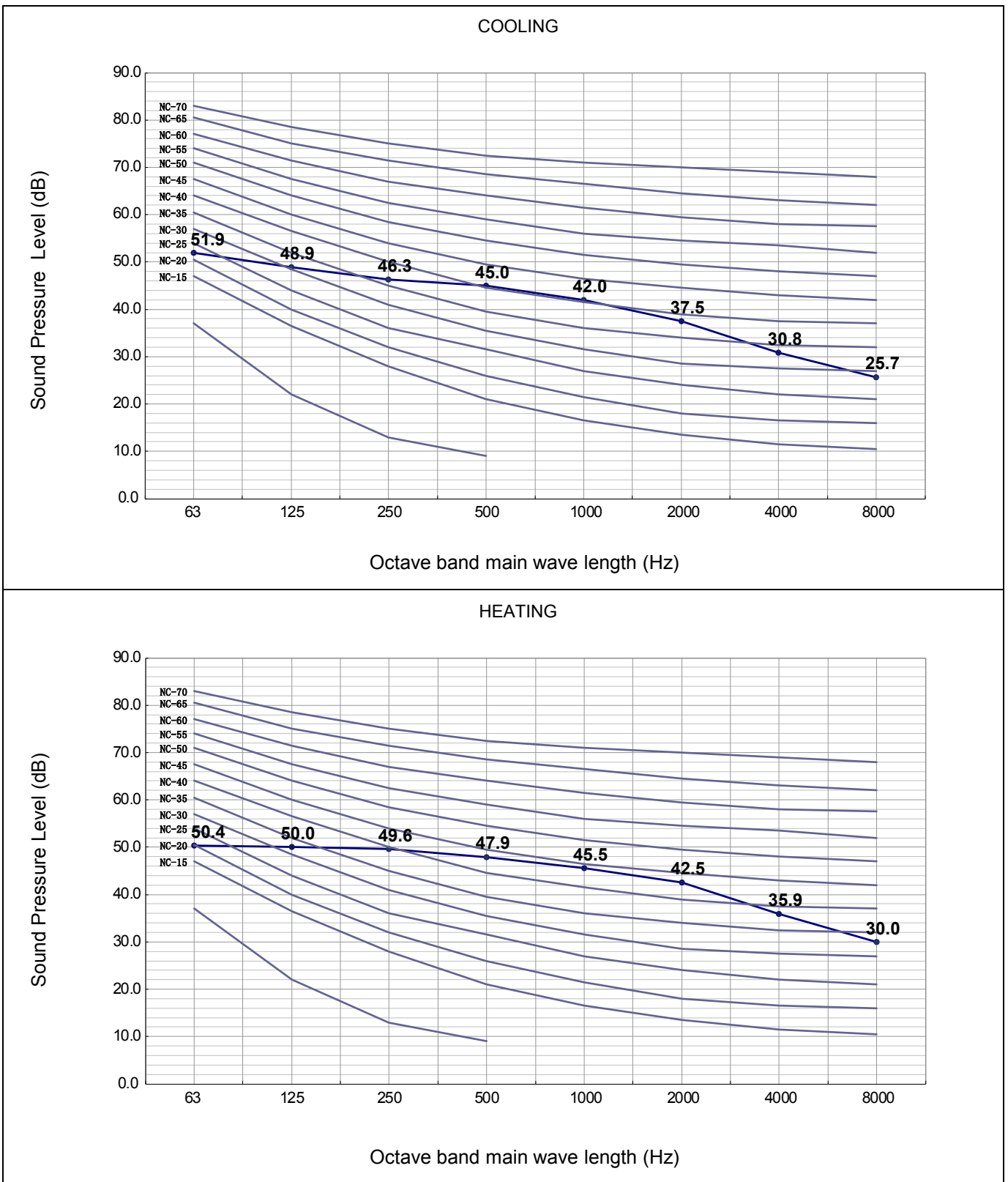

The Sound Pressure Level is based on the following conditions:

- 1 meter from the unit front surface and 1 meter from floor level

The above data was measured in an anechoic chamber. Please take into consideration reflected sound of your specific site

## 4.5. RAC-50WPE

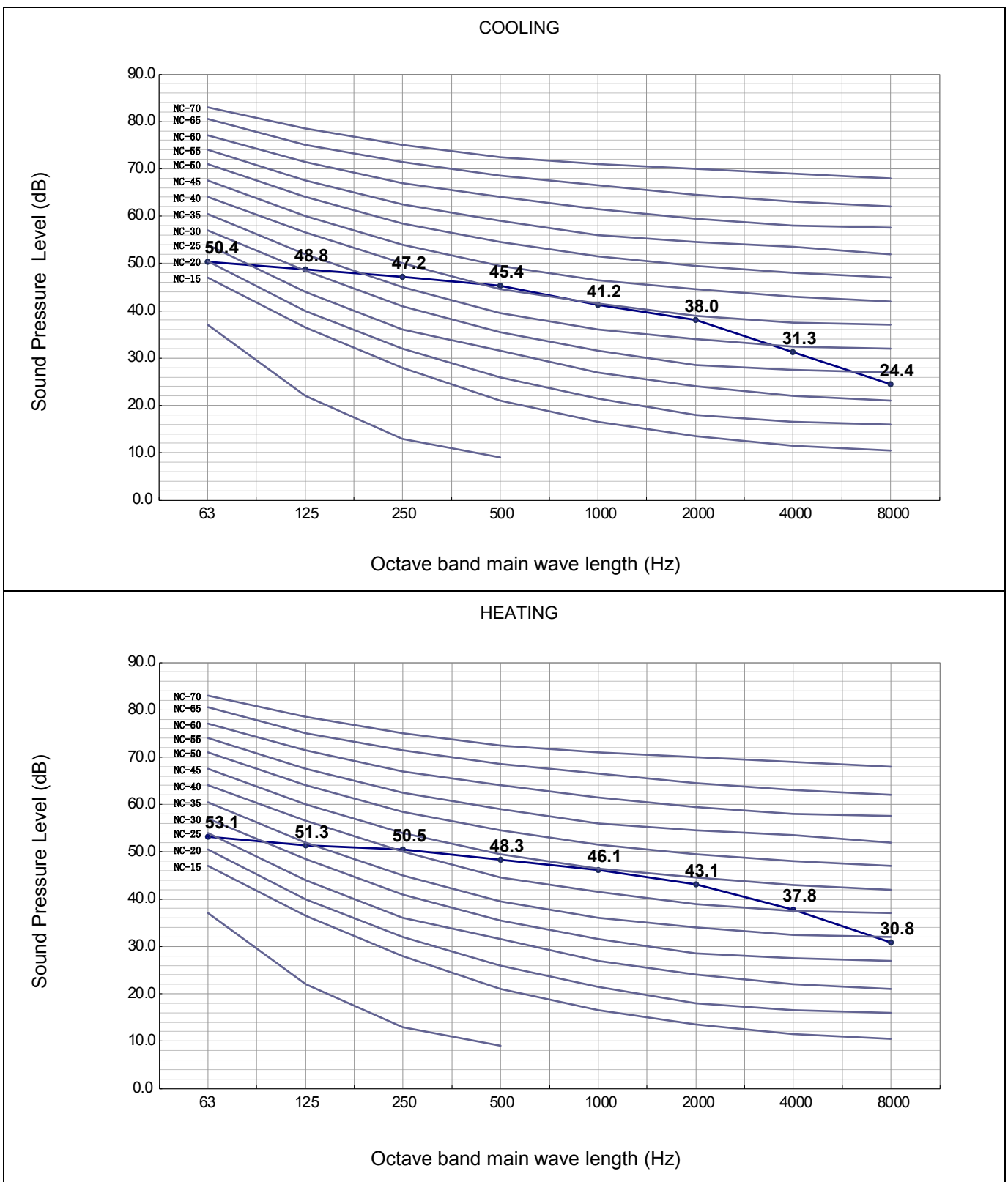

The Sound Pressure Level is based on the following conditions:

- 1 meter from the unit front surface and 1 meter from floor level

The above data was measured in an anechoic chamber. Please take into consideration reflected sound of your specific site

## 5 WORKING RANGE

### 5.1. POWER SUPPLY

|                   |  |
|-------------------|--|
| Working Voltage   | 207V ~ 253V  |
| Voltage Imbalance | Within a 3% Deviation from Each Voltage at the Main Terminal of Outdoor Unit |
| Starting Voltage  | Higher than 85% of the Rated Voltage   |

### 5.2. WORKING RANGE

Applicable models:

|           |
|-----------|
| RAC-18WPE |
| RAC-25WPE |
| RAC-35WPE |
| RAC-42WPE |
| RAC-50WPE |

The temperature range is indicated in the following table.

#### Cooling

| working range | min (°C) | max (°C) | rated (°C) |
|---------------|----------|----------|------------|
| outdoor       | -10      | 43       | 35         |
| indoor        | 16       | 43       | 27         |

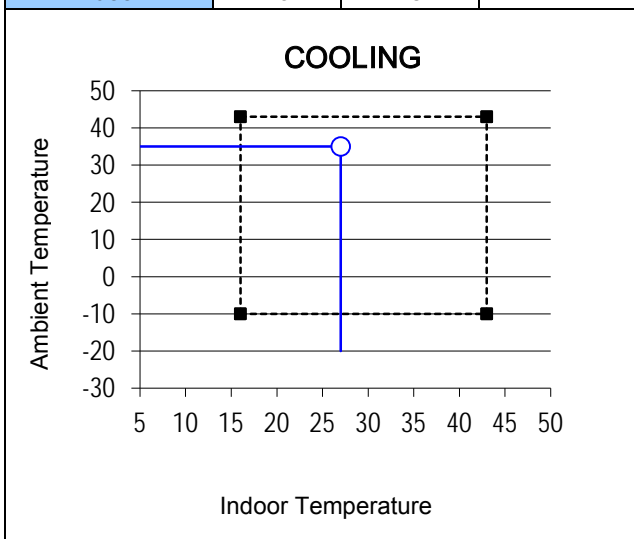

#### Heating

| working range | min (°C) | max (°C) | rated (°C) |
|---------------|----------|----------|------------|
| outdoor       | -15      | 21       | 7          |
| indoor        | 16       | 26       | 20         |

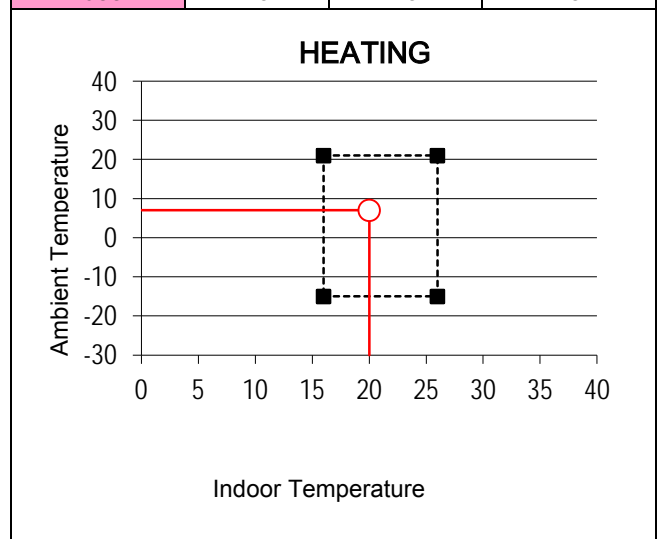

## 6 ELECTRICAL DATA

### 6.1. INDOOR UNIT

| Model     | Unit Main Power |                 | Applicable Current |                   | Indoor Fan Motor |     |
|-----------|-----------------|-----------------|--------------------|-------------------|------------------|-----|
|           | VOL, PH, Hz     | Fuse Rating (A) | STC                | RNC               | RNC              | IPT |
| RAK-18RPE | 230,1, 50       | 3.15            | (C) 2.46 (H)2.93   | (C) 4.39 (H)4.22  | 0.67             | 30  |
| RAK-25RPE | 230,1, 50       | 3.15            | (C) 3.08 (H)3.87   | (C) 5.61 (H)6.52  | 0.67             | 30  |
| RAK-35RPE | 230,1, 50       | 3.15            | (C) 4.81 (H)4.20   | (C) 5.11 (H)7.39  | 0.67             | 30  |
| RAK-42RPE | 230,1, 50       | 3.15            | (C) 5.10 (H)5.99   | (C) 7.39 (H)8.70  | 0.67             | 30  |
| RAK-50RPE | 230,1, 50       | 3.15            | (C) 6.69 (H)7.09   | (C) 8.70 (H)11.96 | 0.67             | 30  |

VOL: Rated Unit Power Supply Voltage (V)

Hz: Frequency (Hz)

STC: Starting Current (A)

RNC: Running Current (A)

PH: Phase ( $\phi$ )

IPT: Input (W)

### 6.2. OUTDOOR UNIT

| Model     | Unit Main Power |                 |         |         | Compressor Motor        |      |                   |      |                   |      |
|-----------|-----------------|-----------------|---------|---------|-------------------------|------|-------------------|------|-------------------|------|
|           | VOL, PH, Hz     | Fuse Rating (A) | Min (V) | Max (V) | Locked Rotor Ampere (A) | STC  | Cooling Operation |      | Heating Operation |      |
|           |                 |                 |         |         |                         |      | RNC               | IPT  | RNC               | IPT  |
| RAC-18WPE | 230,1, 50       | 15              | 207     | 253     | -                       | 2.93 | 4.39              | 419  | 4.22              | 519  |
| RAC-25WPE | 230,1, 50       | 15              | 207     | 253     | -                       | 3.87 | 5.61              | 549  | 6.52              | 733  |
| RAC-35WPE | 230,1, 50       | 15              | 207     | 253     | -                       | 5.11 | 6.35              | 941  | 7.39              | 1000 |
| RAC-42WPE | 230,1, 50       | 25              | 207     | 253     | -                       | 5.99 | 7.39              | 1120 | 8.7               | 1317 |
| RAC-50WPE | 230,1, 50       | 25              | 207     | 253     | -                       | 7.09 | 8.7               | 1471 | 11.96             | 1558 |

VOL: Rated Unit Power Supply Voltage (V)

HZ: Frequency (Hz)

STC: Starting Current (A)

RNC: Running Current (A)

PH: Phase ( $\phi$ )

IPT: Input (W)

#### NOTE:

1. The above compressor data is based on 100% capacity combination of indoor units at the rated operating frequency
2. This data is based on the same conditions as the nominal heating and cooling capacities.
3. The compressor started by an inverter, resulting in extremely low starting current.

# 7 WIRING DIAGRAM

## 7.1. RAK-18RPE/25RPE/35RPE/42RPE/50RPE

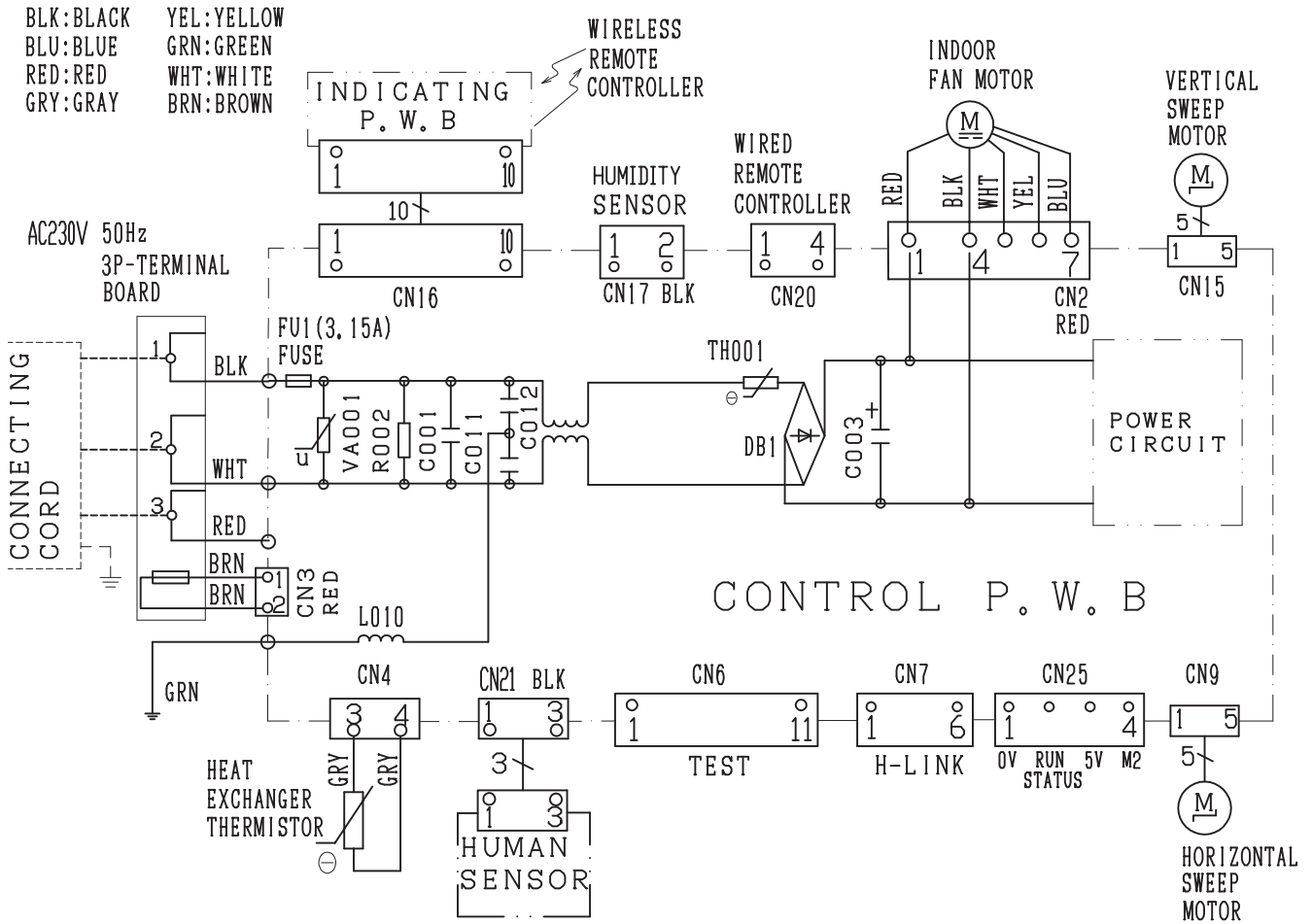

|                          |   |
|--------------------------|---|
| CAUTION!<br>HIGH VOLTAGE | TURN OFF THE POWER SOURCE<br>DURING THE SERVICE WORK. |
|--------------------------|---|

\* SOME MODELS NOT NEED TO  
 INSTALL THE HORIZONTAL  
 SWEEP MOTOR, HUMIDITY SENSOR



7.2. RAC-18WPE/25WPE/35WPE

BLU:BLUE RED:RED  
 BLK:BLACK WHT:WHITE  
 BRN:BROWN YEL:YELLOW  
 GRN:GREEN GRY:GRAY

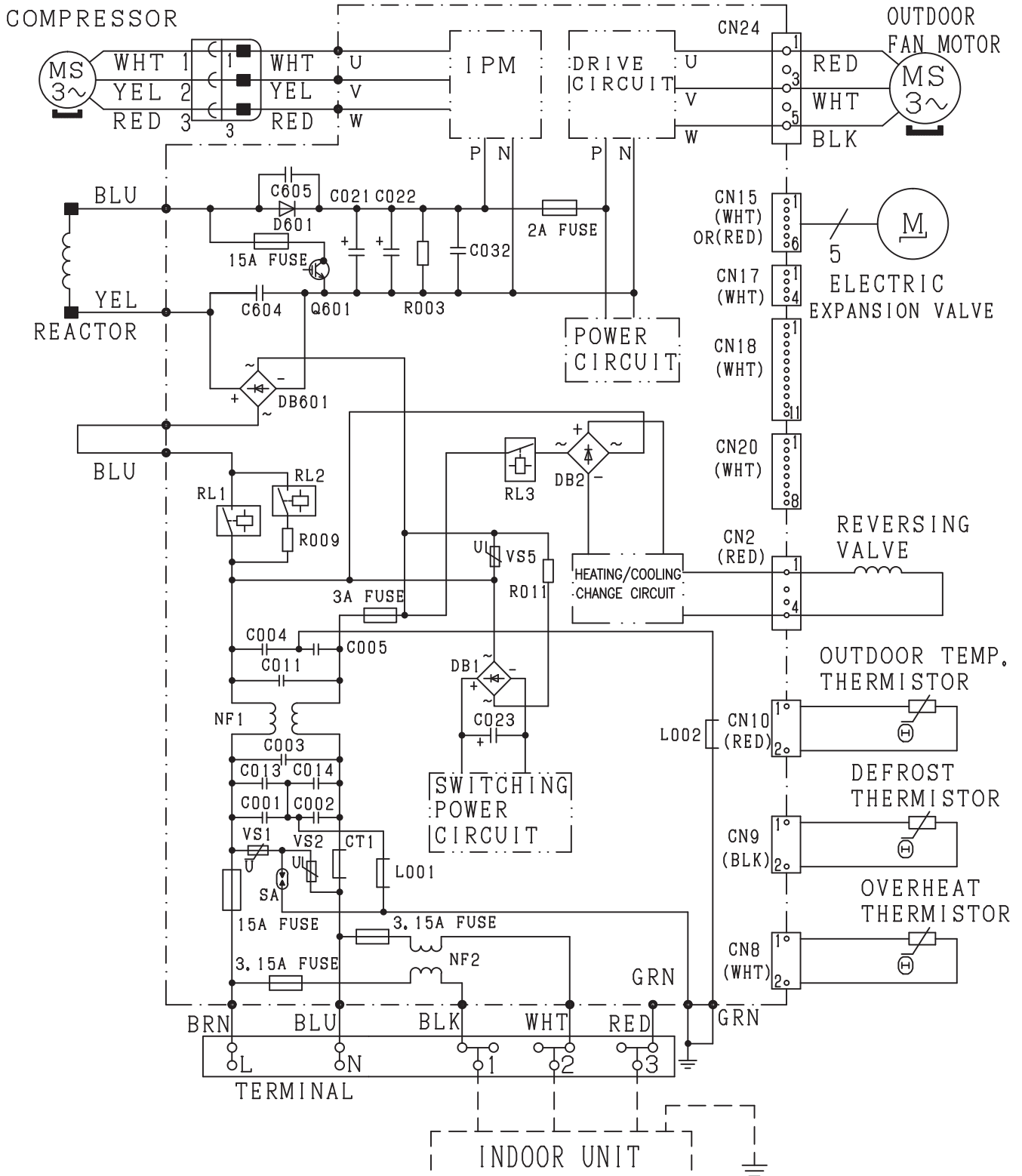

7.3. RAC-42WPE/50WPE

BLU:BLUE RED:RED  
 BLK:BLACK WHT:WHITE  
 BRN:BROWN YEL:YELLOW  
 GRN:GREEN GRY:GRAY

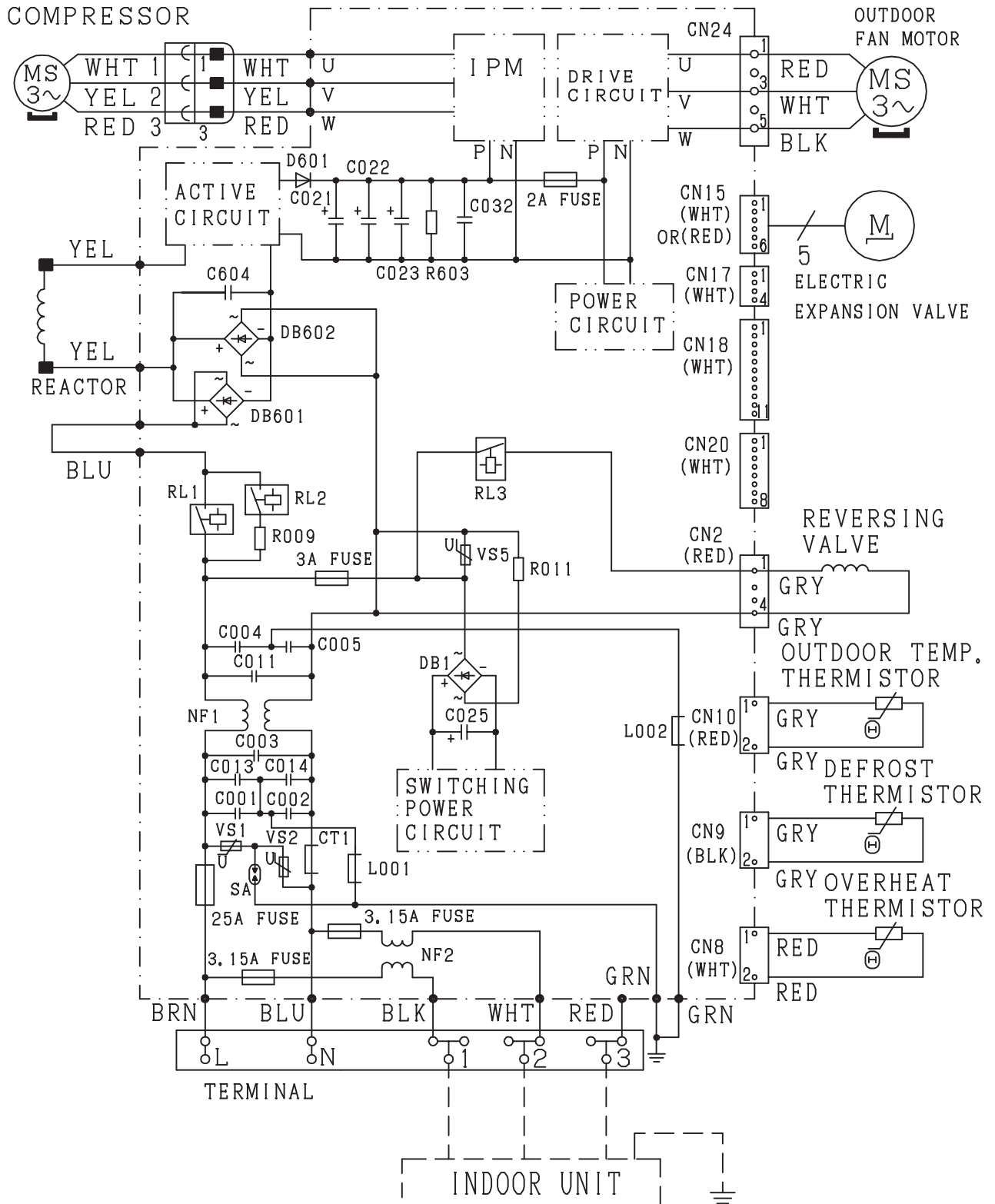

## 8 REFRIGERANT CYCLE

### 8.1. WALL TYPE: RAK-18RPE/RAC-18WPE、RAK-25RPE/RAC-25WPE、RAK-35RPE/RAC-35WPE

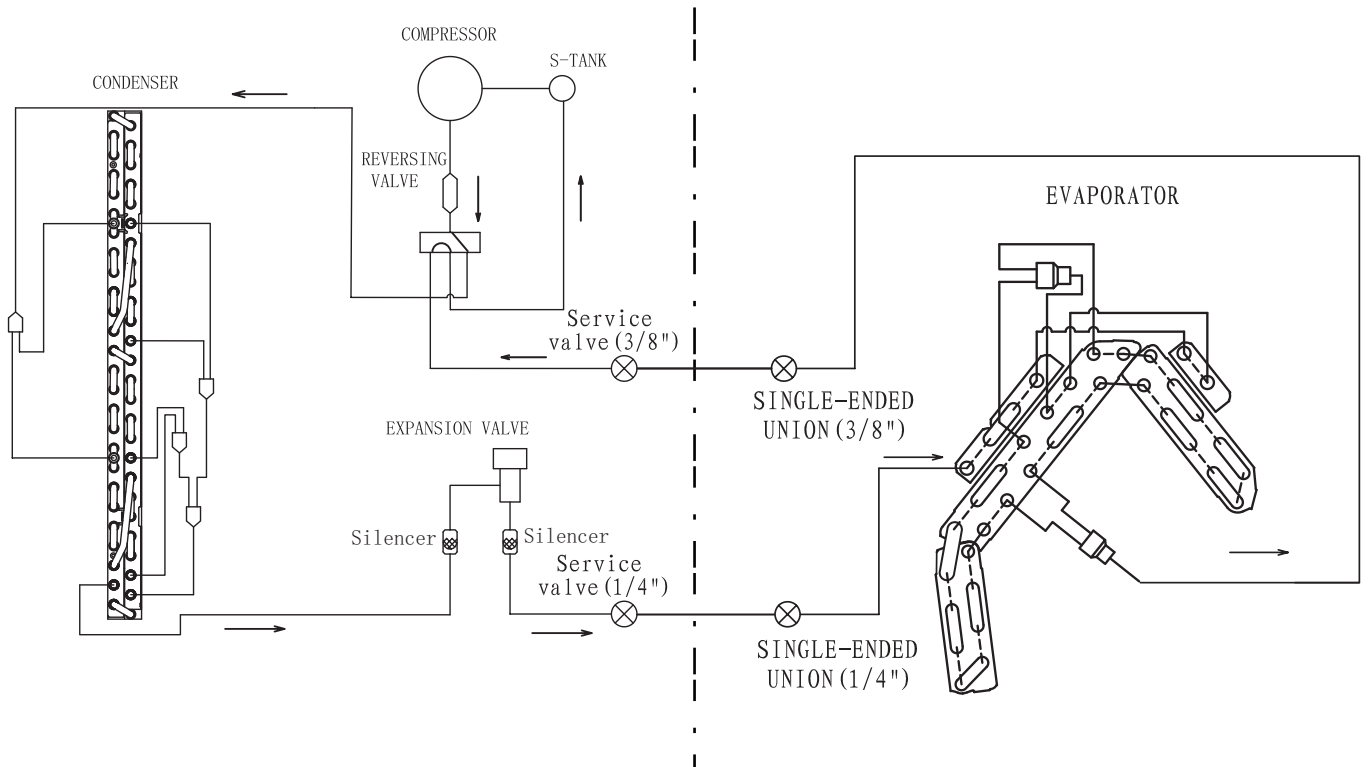

### 8.2. WALL TYPE: RAK-42RPE/RAC-42WPE、RAK-50RPE/RAC-50WPE

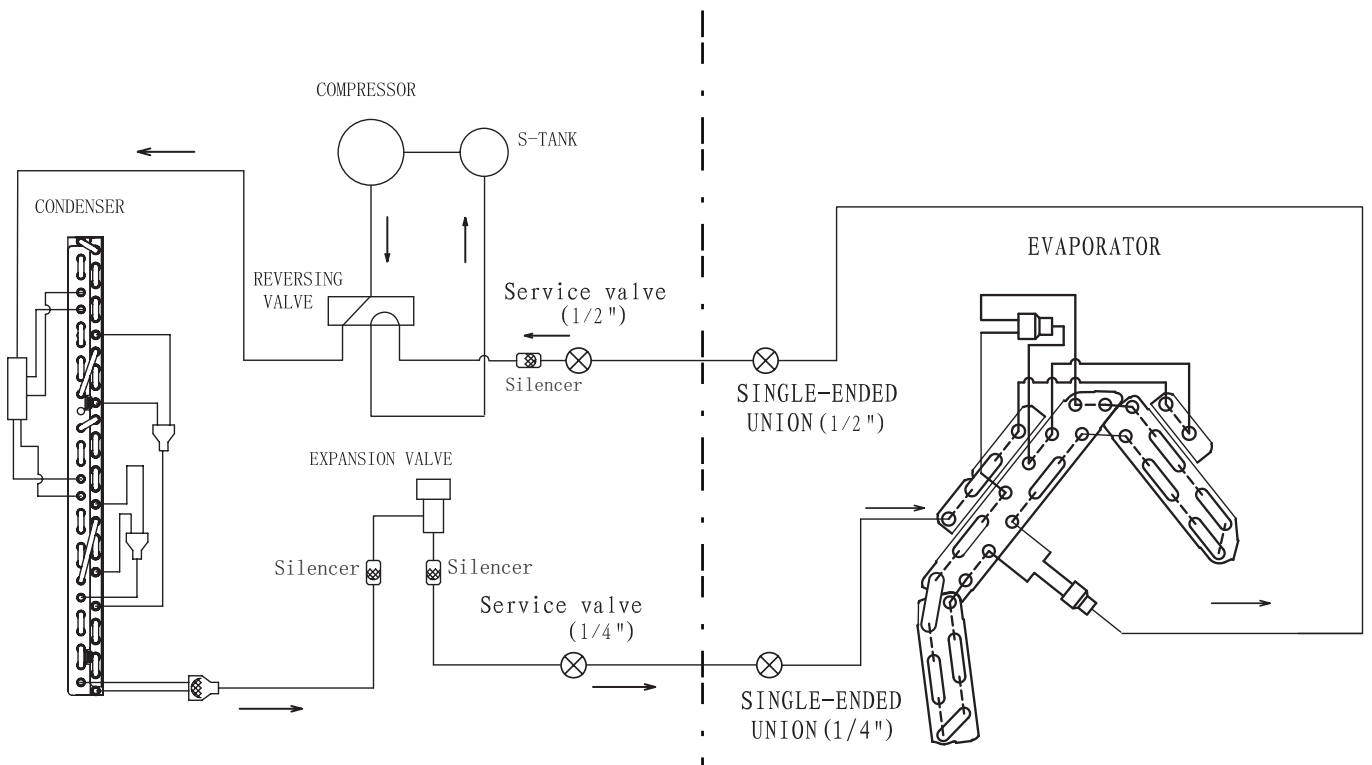







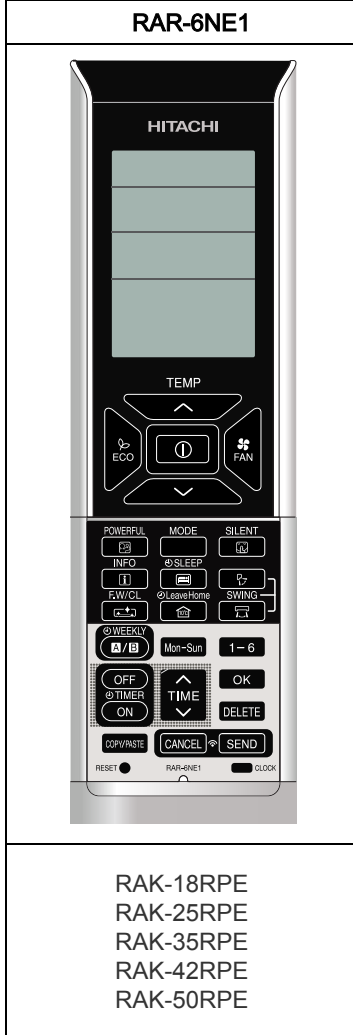

























## 9 CONTROL AND FUNCTION

### 9.1. WIRELESS REMOTE CONTROL FUNCTION

#### REMOTE CONTROLLER TYPE



| BUTTONS   | FUNCTION  |
|---|---|
|    | <b>MODE Selector</b><br>Use this button to select the operations mode. Every time you press this button, the mode will change from  (AUTO) →  (HEAT) →  (DEHUMIDIFY) →  (COOL) and →  (FAN) cyclically.  |
|    | <b>FAN SPEED Selector Button</b><br>This determines the fan speed. Every time you press this button, the airflow rate will change from  (AUTO) →  (HIGH) →  (MED) →  (LOW) →  (SILENT) (This button allows selection of optimal or preferred fan speed for each operation mode). |
|    | <b>START/STOP button</b><br>Press this button to start operation. Press it again to stop operation.   |
|    | <b>ECO button</b><br>Use this button to set the ECO mode.   |
|    | <b>POWERFUL button</b><br>Use this button to set the POWERFUL mode.   |
|    | <b>SILENT button</b><br>Use this button to set the SILENT mode.   |
|    | <b>INFO button</b><br>1) Press this button to display temperature for 10 seconds.<br>2) Press this button to check monthly power consumption.<br>3) Press this button to receive the current calendar and clock.  |
|    | <b>ECO SLEEP TIMER button</b><br>Use this button to set the ECO sleep timer.  |
|    | <b>AUTO SWING (Vertical) button</b><br>Controls the angle of the horizontal air deflector.  |
|    | <b>AUTO SWING (Horizontal) button</b><br>Controls the angle of the vertical air deflector.  |
|   | <b>LEAVE HOME button</b><br>Prevent the room temperature from falling too much by setting temperature 10°C~16°C when no one is at home  |
|  | <b>FROST WASH / CLEAN button</b><br>The dust and dirt adhering to indoor heat exchanger which is the cause of the smell. They are washed away by freezing and thawing of the heat exchanger.  |
| <b>WEEKLY TIMER buttons</b>   |   |
|  | <b>ON/OFF TIMER button</b><br>The device will turn on (off) and off (on) at the designated time.  |
|  | <b>TIME button</b><br>Press the button to set starting time of the program  |
|  | <b>OK button</b><br>Press the button to save the program. The button shall be pressed everytime after finishing a program setting.  |
|  | <b>DELETE button</b><br>1) Press the button to delete the selected program.<br>2) Press the button for about 10 seconds by directing the remote controller towards the indoor unit while Mode A or B display blinks, programs for Mode A or B will be deleted both from the indoor unit and the remote controller after the beep sound from the indoor unit.  |
|  | <b>DAY button</b><br>Select the desired day of the week.  |
|  | <b>PROGRAM NO. button</b><br>Press this button to select a program number.  |
|  | <b>CANCEL</b><br>1) Press the button to cancel the current setting process on the screen.<br>2) Press the button by directing the remote controller towards the indoor unit, then weekly timer setting will be canceled from indoor unit after the beep sound from the indoor unit. The program setting remains in the remote controller.   |
|  | <b>SEND button</b><br>Press the button for about 3 seconds by directing the remote controller towards the indoor unit after finishing the program setting. Timer lamp on the indoor unit will blink rapidly and after the beep sound from indoor unit, TIMER lamp will light up.  |
|  | <b>CLOCK button</b><br>Press the button to set calendar and clock.  |
|  | <b>WEEKLY TIMER MODE button</b><br>1) Select Mode A or Mode B. 2 modes can be set and stored as a weekly timer.<br>2) By pressing the button longer than 3 seconds, program setting screen will appear.   |

### 9.2. AUTO CHANGEOVER

COOLING/HEATING mode is decided by the room temperature.

- A. COOLING/HEATING mode is decided during the **initial startup** of Automatic Operation  
 Initial startup of Automatic Operation means the following either condition:
- Unit start up in Automatic Operation
  - Automatic Operation mode is pressed while the unit is running in manual mode

| Startup room temperature                 | COOL / HEAT               |
|--|---------------------------|
| >= Remote controller setting temperature | Unit runs in COOLING mode |
| < Remote controller setting temperature  | Unit runs in HEATING mode |

- B. COOLING/HEATING mode is decided in **intervals after the initial startup** of Automatic Operation (also known as Auto Changeover function)

| Intervals                | Duration         |
|--------------------------|------------------|
| 1 <sup>st</sup> interval | 10 minutes       |
| 2 <sup>nd</sup> interval | 15 minutes       |
| Subsequent interval      | Every 55 minutes |

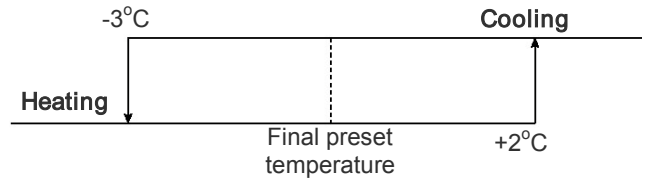

### 9.3. SHIFT VALUE

1. Press and hold (START/STOP) button and (ON) button.
2. Press (RESET) [RESET] button on the same time. Release (RESET) [RESET] button only, then release (START/STOP) and (ON) button once Screen 1 appears.

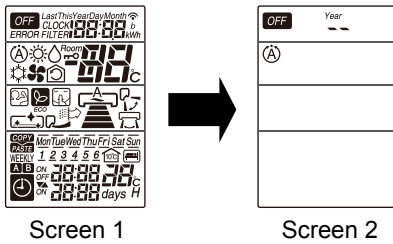

4. Press (START/STOP) and Screen 4 appear.

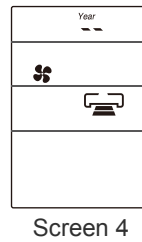

3. Press the (MODE) button to display fan mode (Screen 3).

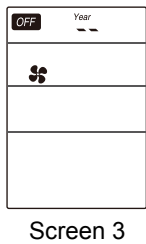

5. Select (FAN SPEED) button to choose Heating Shift or Cooling Shift Mode (Screen 5).

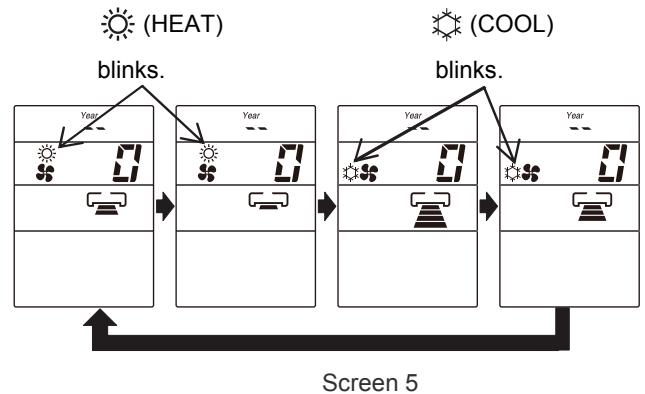

By setting fan speed to HIGH or MED , it will go to Cooling Shift mode.  
 By setting fan speed to LOW or SILENT , it will go to Heating Shift mode.

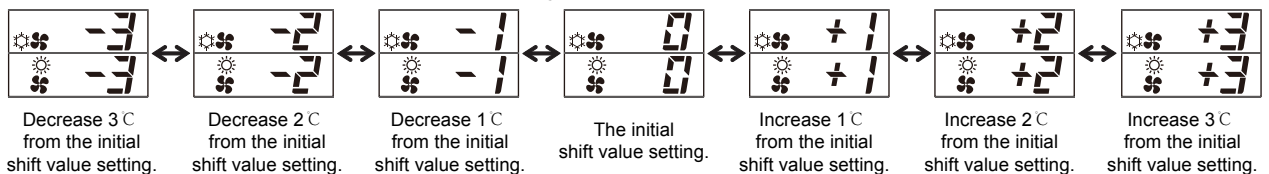

6. Press the Temperature button (V or ^) to adjust the shift value.









## NOTE:

1. There are total of 7 shift values ranging from -3 to 3.
2. The displayed shift value,  (HEAT) and  (COOL) symbol on the remote controller display will be disappear after 10 seconds
3. The changed shift value will remain unchanged after turned off the power.
4. If "0" is displayed on the remote controller display, it indicates the shift value is now at the initial setting.

## 9.4. OPERATION LOCK

### 1. HEATING MODE

- a) Press and hold  (ECO) and  (POWERFUL) buttons, press  (RESET) button on the same time. Release  (RESET) button only when Screen 1 appear, then release  (ECO) button and  (POWERFUL) button.

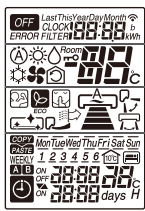

Screen 1



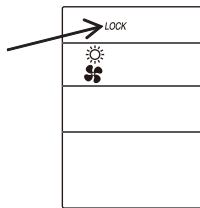

- b) Wait until only Screen 2 appear.





Screen 2

- c) The heating mode operation is locked.  
 d) To unlock HEATING mode, repeat step (a). After all operations mode symbols displayed for 10 seconds, the operation mode symbol before cancellation will be display. The heating mode operation is unlocked.

### 2. COOLING AND DEHUMIDIFYING MODE

- a) Press and hold  (ECO) and  (SILENT) buttons for at least 5 seconds when the remote controller is OFF.  
 b) Wait until only  and  displayed on the screen. The cooling and dehumidifying modes operation is locked.  
 c) To unlock HEATING mode, repeat step (a). After all operations mode symbols displayed for 10 seconds, the operation mode symbol before cancellation will be display. The cooling and dehumidifying mode operation is unlocked.

## 9.5. SETTING THE PREVENTION OF MUTUAL INTERFERENCE

1. Please ensure the other indoor unit is OFF.
2. Press  (PROGRAM NO.) button,  (ON TIMER) button and  (RESET) button simultaneously. The remote controller will display Screen 1 and followed by Screen 2. The indoor unit beeps to indicate that it has just received the signal from remote controller.

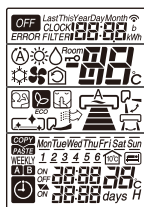

Screen 1

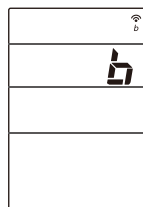

Screen 2

## NOTE:

1. If indoor unit still not receive the correct signal from the correct remote controller, setting shall be made again. By setting again for the 2nd time, the signal address will change from B to A, then repeat again for the 3rd time.

### 9.6. INTERMITTENT FAN SPEED SETTING

The intermittent fan control during thermo off in Heating Mode can be changed by the remote controller. (This procedure should be done only by service personnel.) It is possible to select from 3 patterns.

#### PROCEDURE

- Press [START/STOP] button, [Mon-Sun] button and press [RESET] button simultaneously. Release [RESET] button only and make sure that all marks on the remote controller display are indicated, then release [START/STOP] button and [Mon-Sun] button. Remote controller now enters "Intermittent Fan Control Change Mode".

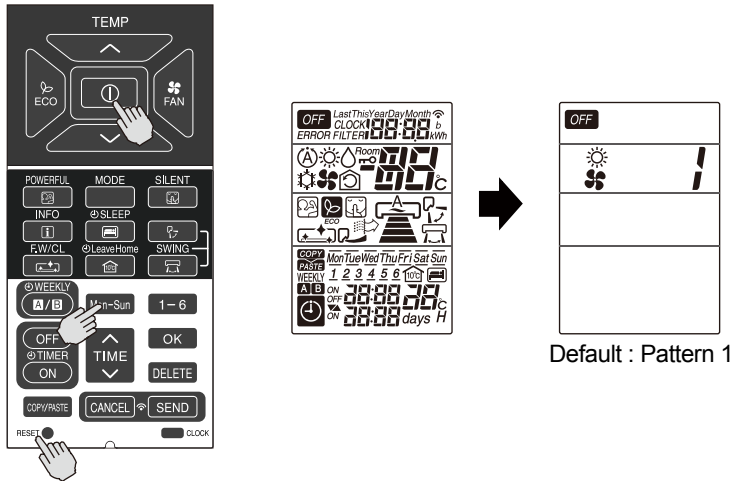

- Press [ROOM TEMPERATURE setting] [ $\wedge$ (UP)]/[ $\vee$ (DOWN)] buttons. (The intermittent pattern changed with indoor unit beep sound.)

Transmission sign lights up with beep from indoor unit simultaneously.

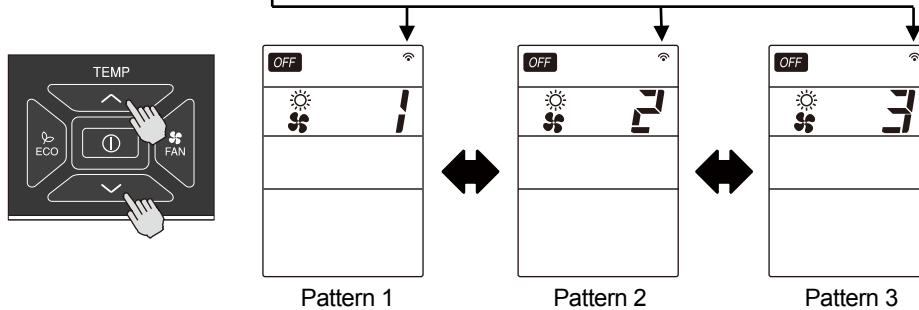

|              | Pattern 1                        | Pattern 2                        | Pattern 3                        |
|--------------|----------------------------------|----------------------------------|----------------------------------|
| Single Model | Continuous                       | 30sec ON / 210sec OFF repeatedly | 50sec ON / 190sec OFF repeatedly |
| Multi Model  | 30sec ON / 210sec OFF repeatedly | 50sec ON / 190sec OFF repeatedly | Continuous                       |

NOTE :



- (1) The indication of the selected intermittent pattern will disappear after 10 seconds.
- (2) The selected intermittent pattern will remain unchanged after the unit is turned off.



## 9.7. FAN SPEED SETTING IN THERMO OFF IN COOLING

The fan speed in Cooling Mode during thermo off can be changed by the remote controller.  
(This procedure shall be implemented strictly by service personnel only.)  
It is possible to return it to the default setting.

### PROCEDURE

Press  [POWERFUL] button and  [TIME ^ (UP)] button simultaneously for about 5 seconds when the remote controller is OFF.

Transmission sign lights up with beep from indoor unit simultaneously.

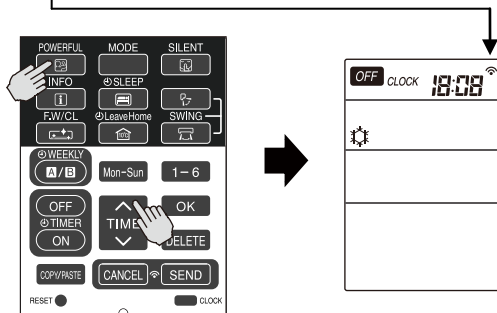



Beep sound pattern :  
 1) Default setting : Short beep  
 2) Changed setting : Double beep

|                 | Fan speed during thermo off                                      |
|-----------------|--|
| Default Setting | Ultra low  |
| Changed Setting | Set fan speed (When auto fan speed is set, the fan speed is low) |

#### NOTE :

- (1) The selected fan speed will remain unchanged after the unit is turned off.
- (2) If Timer reservation has been set, it will be canceled.
- (3) During time setting and timer setting, this operation cannot be set.

## 9.8. ERROR CODE INFORMATION

1. In case failure occurs to the air conditioner, by pressing  (INFO) button, an error code will be displayed.
2. Direct the remote controller towards the receiver of indoor unit (within 2 meters in from of indoor unit) and press  (INFO) button.
3. Wait for 2 seconds for signal transmission and the error code will be displayed.

|         | TIMER LAMP BLINKING | LED301 BLINKING | CODE      | MEANING  |
|---------|---------------------|-----------------|-----------|--|
| INDOOR  | -                   | -               | 000<br>00 | Normal   |
|         | 1 time              | -               | 001<br>00 | Refrigerant cycle fault                              |
|         | 2 times             | -               | -         | Outdoor unit is under forced operation               |
|         | 3 times             | 9 times         | 003<br>00 | Communication error between indoor and outdoor units |
|         | 9 times             | -               | 009<br>00 | Indoor thermistor                                    |
|         | 10 times            | -               | 010<br>00 | Abnormal rotating numbers                            |
|         | 12 times            | -               | 012<br>00 | Communication error between indoor and outdoor units |
|         | 13 times            | -               | 013<br>00 | IC401 data reading error                             |
| OUTDOOR | 4 times             | 2 times         | 002<br>01 | Peak current cut                                     |
|         | 4 times             | 3 times         | 003<br>01 | Compressor abnormal low speed rotation               |
|         | 4 times             | 4 times         | 004<br>01 | Compressor switching failure                         |
|         | 4 times             | 5 times         | 005<br>01 | Overload lower limit cut                             |
|         | 4 times             | 6 times         | 006<br>01 | OH thermistor temperature rise                       |
|         | 4 times             | 7 times         | 007<br>01 | Abnormal outdoor thermistor                          |
|         | 4 times             | 9 times         | 009<br>01 | Communication error                                  |
|         | 4 times             | 10 times        | 010<br>01 | Abnormal power source                                |
|         | 4 times             | 11 times        | 011<br>01 | Fan stop for strong wind                             |
|         | 4 times             | 12 times        | 012<br>01 | Fan motor fault                                      |
|         | 4 times             | 13 times        | 013<br>01 | EEPROM reading error                                 |
|         | 4 times             | 14 times        | 014<br>01 | Active converter defective                           |
|         | 4 times             | 15 times        | 015<br>01 | Abnormal PWB circuit                                 |
|         | 4 times             | 16 times        | 016<br>01 | Hign load stop                                       |

## 9.9. ADDITIONAL FUNCTION VIA DIP-SWITCH SETTINGS

A new DIP Switch is available on the PWBs of the indoor unit that provide additional functions via the settings on the switches.

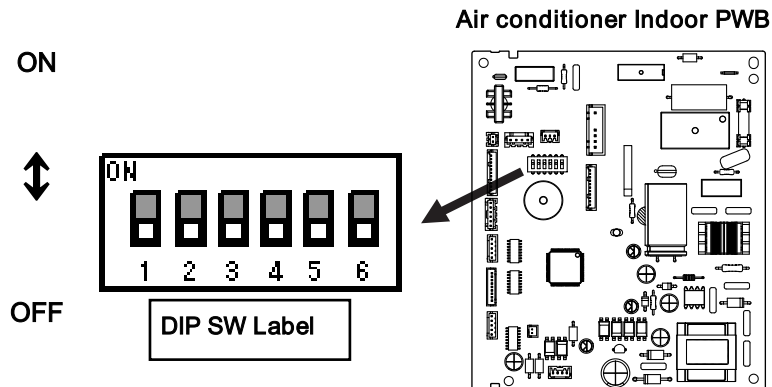

| SW No. | I T E M                          | F U N C T I O N |                   |     |                  |     |              |    |                   |
|--------|----------------------------------|-----------------|-------------------|-----|------------------|-----|--------------|----|-------------------|
| 1      | AUTO RESTART                     | OFF*            | ENABLE            | ON  | DISABLE          |     |              |    |                   |
| 2      | CARD KEY MODE                    | OFF*            | DISABLE           | ON  | ENABLE           |     |              |    |                   |
| 3      | CARD KEY LOGIC SELECT            | OFF*            | INPUT HIGH ACTIVE | ON  | INPUT LOW ACTIVE |     |              |    |                   |
| 4      | HEATING/COOLING ONLY MODE SELECT | OFF*            | HEATING & COOLING | OFF | HEATING ONLY     | ON  | COOLING ONLY | ON | HEATING & COOLING |
| 5      | HEATING/COOLING ONLY MODE SELECT | OFF*            |                   | ON  |                  | OFF |              | ON |                   |
| 6      | REMOCON ID SELECT                | OFF*            | SELECT ID : A     | ON  | SELECT ID : B    |     |              |    |                   |

NOTE:

\* Marking is position of shipping [FACTORY default setting]

### 9.9.1. AUTO RESTART FUNCTION

The AUTO RESTART function can be enabled or disabled by setting Pin No. 1 on the DIP SWITCH above to the ON or OFF position accordingly.





















### 9.9.2. HEATING/COOLING ONLY MODEL SELECTION

When this function is enabled, the operation mode could be locked to either Heating Only (Heating or Fan) or Cooling Only (Cooling, Fan or Dehumidifying) by setting the Pin No. 4 and 5 accordingly.





| LOCKED MODE  | REMARKS  |
|--------------|--|
| HEATING ONLY | Unit will not enter into Cooling mode although cooling mode is selected using the remote controller. |
| COOLING ONLY | Unit will not enter into Heating mode although heating mode is selected using the remote controller. |

## 10 OPTION LIST



### 10.1. WIRED REMOTE CONTROL – SPX-RCDB



|  <p>RAR-5G2 (SPX-RCDB)</p> | BUTTONS   | FUNCTION  |
|--|---|---|
|  |    | <b>MODE Selector</b><br>Use this button to select the operating mode. Every time you press this button, the mode will change from  (AUTO) →  (HEAT) →  (DEHUMIDIFY) →  (COOL) and →  (FAN) cyclically.   |
|  |    | <b>FAN SPEED Selector Button</b><br>This determines the fan speed. Every time you press this button, the airflow rate will change from  (AUTO) →  (HIGH) →  (MED) →  (LOW) →  (SILENT) (This button allows selection of optimal or preferred fan speed for each operation mode). |
|  |    | <b>ON/OFF button</b><br>Press this button to start operation. Press it again to stop operation.   |
|  |    | <b>SLEEP button</b><br>Use this button to set the SLEEP timer.  |
|  |    | <b>SET button</b><br>Timer setting reservation.   |
|  |    | <b>OFF button</b><br>Select the turn OFF timer.   |
|  |    | <b>ON button</b><br>Select the turn ON timer.   |
|  |  | <b>CANCEL button</b><br>Cancel timer reservation.   |
|  |  | <b>AUTO SWING (Vertical) button</b><br>Controls the angle of the horizontal air deflector.  |
|  |  | <b>ROOM TEMPERATURE setting button</b><br>Value will change quicke when keep pressing.  |

#### 10.1.1. SHIFT VALUE

1. Press and hold  (ON/OFF) button and  (ON TIMER) button at the same time while giving a single press on the RESET button until remote controller now enter 'Shift value change mode'.
2. Press  (ON/OFF) button so that the display indicates  (FAN) speed.
3. Select  (FAN SPEED) button to choose Heating Shift or Cooling Shift Mode.

By setting fan speed to HIGH  or MED  , it will go to Cooling Shift mode.

By setting fan speed to LOW  or SILENT  , it will go to Heating Shift mode.



4. Press  (ROOM TEMPERATURE) button to change the shift value (-3°C ~ 0 ~ 3°C).
5. Press  (ON/OFF) button to end 'Shift value setting mode'.



#### NOTE:

1. There are total of 7 shift values ranging from -3 to 3.
2. The changed shift value will remain unchanged after turned off the power.

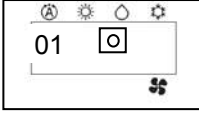
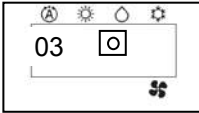
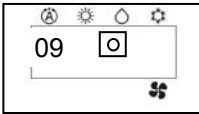
## 10.1.2. ERROR CODE INFORMATION

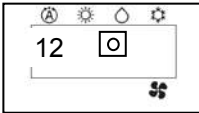
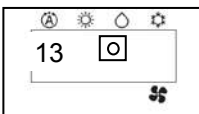
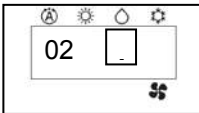
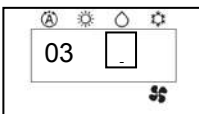
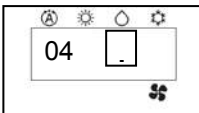
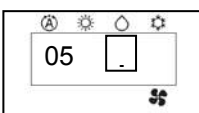
1. In case failure occurs to the air conditioner, the error code will constantly appear on the wired remote controller display.

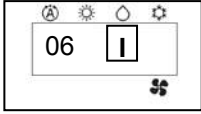
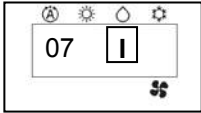
|         | TIMER LAMP BLINKING | LD301 BLINKING | CODE  | MEANING  |
|---------|---------------------|----------------|---|--|
| INDOOR  | -                   | -              | -   | Normal   |
|         | 1 time              | -              |    | Refrigerant cycle fault                              |
|         | 2 times             | -              | -   | Outdoor unit is under forced operation               |
|         | 3 times             | 9 times        |    | Communication error between indoor and outdoor units |
|         | 9 times             | -              |   | Indoor thermistor defective                          |
|         | 10 times            | -              |  | Abnormal rotating numbers                            |
|         | 12 times            | -              |  | Communication error between indoor and outdoor units |
|         | 13 times            | -              |  | IC401 data reading error                             |
| OUTDOOR | 4 times             | 2 times        |  | Peak current cut                                     |
|         | 4 times             | 3 times        |  | Compressor abnormal low speed rotation               |
|         | 4 times             | 4 times        |  | Compressor switching failure                         |
|         | 4 times             | 5 times        |  | Overload lower limit cut                             |

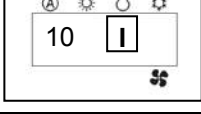
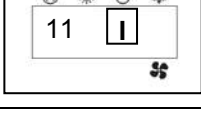
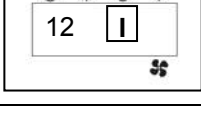
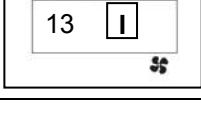
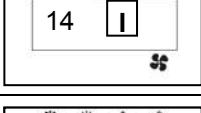
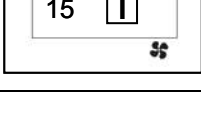
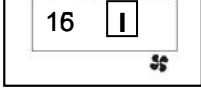
|         | TIMER LAMP BLINKING | LD301 BLINKING | CODE  | MEANING                        |
|---------|---------------------|----------------|---|--------------------------------|
| OUTDOOR | 4 times             | 6 times        |    | OH thermistor temperature rise |
|         | 4 times             | 7 times        |    | Abnormal outdoor thermistor    |
|         | 4 times             | 9 times        |    | Communication error            |
|         | 4 times             | 10 times       |    | Abnormal power source          |
|         | 4 times             | 11 times       |    | Fan stop for strong wind       |
|         | 4 times             | 12 times       |  | Fan motor fault                |
|         | 4 times             | 13 times       |  | EEPROM reading error           |
|         | 4 times             | 14 times       |  | Active converter defective     |
|         | 4 times             | 15 times       |  | Abnormal PWB circuit           |
|         | 4 times             | 16 times       |  | High load stop                 |

## 10.2. H-LINK ADAPTOR – PSC 6RAD

### 10.2.1. SAFETY SUMMARY

**DANGER:**

- DO NOT pour water into the remote control switch (hereafter called “controller”). This product is equipped with electrical parts. This will cause serious electrical shock.

**WARNING:**

- DO NOT perform installation work and electrical wiring connection by yourself. Contact your distributor or dealer of HITACHI and ask them for installation work and electrical wiring by service person. The specified cable should be used to connect (i) room air conditioner and adaptor, and (ii) controller and adaptor.



**CAUTION:**



- DO NOT install the indoor unit, outdoor unit, controller and cable as such places as:
  - where there is oil vapor and dispersion of oil
  - where there is sulfuric environment (near the hot springs)
  - where there is a flammable gas
  - where there is salty environment (near the sea)
- DO NOT install the indoor unit, outdoor unit, controller and cable within approximately 3 meters from strong electromagnetic wave radiators, such as medical equipment. In case that the controller is installed in a place where there is electromagnetic wave direct-radiation, shield the controller and cables by covering with the steel box and running the cable through the metal conduit tube.
- In case that there is electric noise at the power source for the indoor unit, provide a noise filter.

### 10.2.2. INSTALLATION WORK

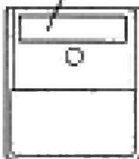
■ Before installation

Check the contents and the number of the accessories in the packing.

|  |  |
|--|--|
| Adaptor                                  |  With two 1.8m cables   |
| 1 piece of cover for hiding the covering |  Attached 2 sided tapes |
| Two-sided tape for attaching to Adaptor  |  110x40x3mm             |

|  |   |             |
|--|---|-------------|
| 2 connectors for H-Link connection     |  |             |
| 2 tapping screws for attaching to wall |  | φ3.0 x 10mm |
| 2 screws for attaching to wooden wall  |  | φ3.1 x 16mm |

- 1) RAC adaptor can be installed to the wall as well as on the air conditioner itself
- 2) Install RAC adaptor in the vertical surface as shown below.

Upper side

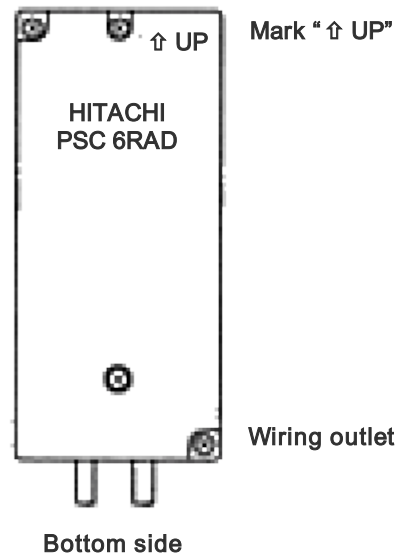

Bottom side

- 3) Installation procedure
  - a) When installing to the wall.
    - i) Fix the adaptor with 2 screws. Tapping screw is for metal surface, and other screw is for wooden surface.

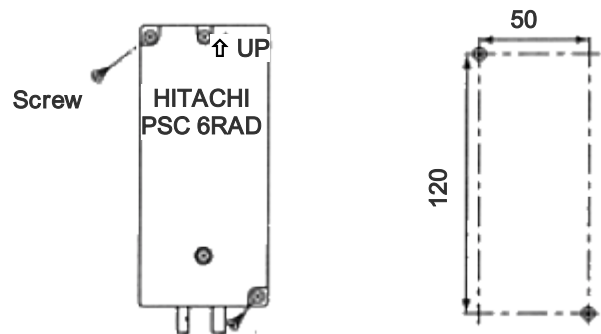

- ii) When using the cover
 

It can be installed at the right and left side of room air conditioner. Fix the cover and RAC adaptor with the two-sided tape (accessory).

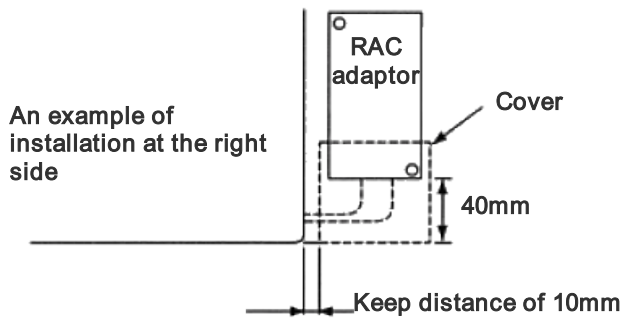

- b) When installing on the room air-conditioner
- In case that it cannot be installed to the wall due to the space or material problem, install the RAC adaptor with the two-sided tape (accessory) on the room air-conditioner.
- Confirm if the piping cover of the unit can be removed when performing the service maintenance, and then fix the RAC adaptor in the side of room air-conditioner with two-sided tape. (Available at the right as well as left side)
  - Clean the surface to be installed with a dry cloth.

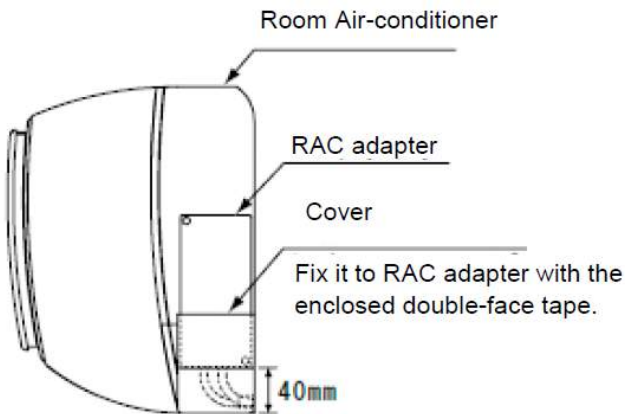
**NOTE:**

- Consider the following points since the adhesiveness changes according to the environmental conditions (temperature, humidity etc)
- The adhesiveness is decreased when there is humidity or oil.
- Warm the adhesive part and installation place of the two-sided tape to avoid the decrease of the adhesiveness in case the ambient temperature is low.
- DO NOT touch the adhesive part by fingers nor re-attach it many times. The adhesiveness has decreased and the RAC adaptor may fall off.
- DO NOT apply any force within 24 hours after installation.

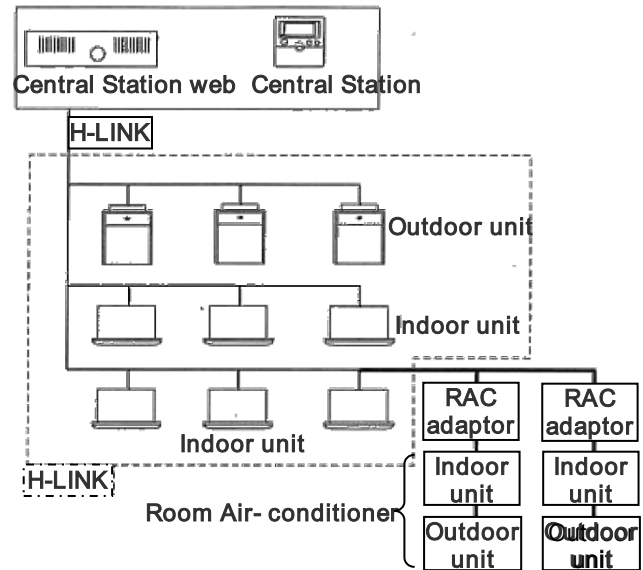
**10.2.3. ELECTRICAL WIRING****■ System configuration****CAUTION:**

- Turn OFF the power supply of the room air-conditioner of the central control device when performing the wiring work
- DO NOT run all the H-LINK cable or power supply cable along the other signal cable, or malfunction may occur due to the noise, etc. If it is required to run along the other transmission cable, separate the cable more than 30cm, or run the cable through the metal tube and earth the tube.
- Follow local codes and regulations when performing electrical wiring and earth wiring.
- Transmissions cable used in H-LINK shall be 2 cores cable ( $0.7\text{mm}^2$  to  $1.25\text{mm}^2$  for model: VCTF, VCT, CVV, MVVX, CVVX, VVR, VVF) or 2 cores twisted pair cable (model: KPEV, KPEV-Spec). Total length of cable shall be below 1000mm.
- DO NOT use wire with more than 3 cores.

**■ Internal components and Wiring connections**

Check the contents and the number of the accessories in the packing.

- Access
- Open the cover by removing the ① and ② screws.



- Wiring Connection
- Connection with Room Air-Conditioner
  - Remove the front cover of the room air-conditioner and the cover of electrical box.
  - The cable attached with the connector of the RAC adaptor shall be connected with the connector of indoor PCB



- iii) Install the electrical box cover paying attention not to clamp the cable. Read the installation manual of each room air-conditioner for confirming how to connect and how to assemble the cable of the RAC adaptor.

**CAUTION:**

- Disconnect the power plug before performing this work
- Turn OFF the break power source in case the power is supplied from the outdoor unit.
- Connection of Transmission Cable  
H-LINK transmission cable connecting to RAC adaptor shall be connected to H-LINK.

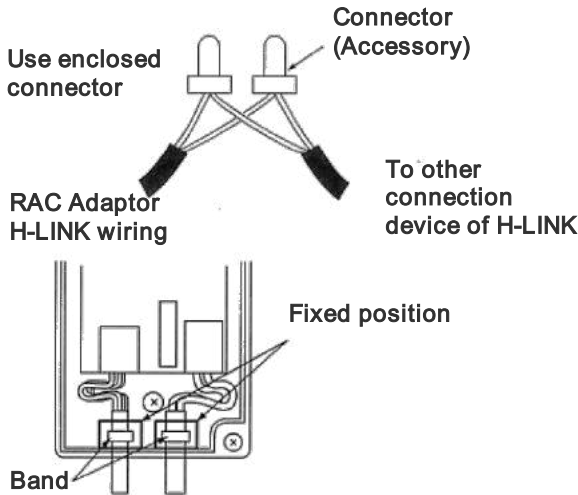

**CAUTION:**

- DO NOT connect incorrect wiring. It may cause the failure of the RAC Adaptor. Especially pay attention not to apply high voltage e.g. AC400/230V.
- DO NOT perform the wiring work while power to the central station or the RAC Adaptor is still being supplied. It may cause malfunction. Turn OFF devices when performing the wiring work.
- The RAC Adaptor side cable should not overload to the connector.
- DO NOT clamp the cable when attaching the RAC adaptor cover.
- Band should not be loose and in fixed position.

**10.2.4. DIP SWITCH SETTING**

- 1) Switch OFF the power of room air conditioner before setting the DIP switch. If the power is ON, the settings are INVALID.
- 2) The position of the DIP switch is shown below.

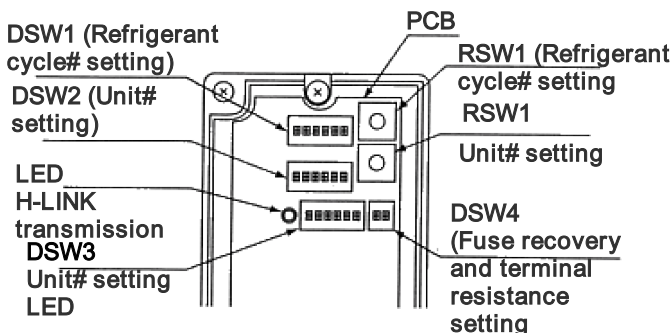

**CAUTION:**

- DO NOT turn ON various pins of DSW1 and DSW2

- 3) Set the refrigerant cycle# by RSW1 and DSW1

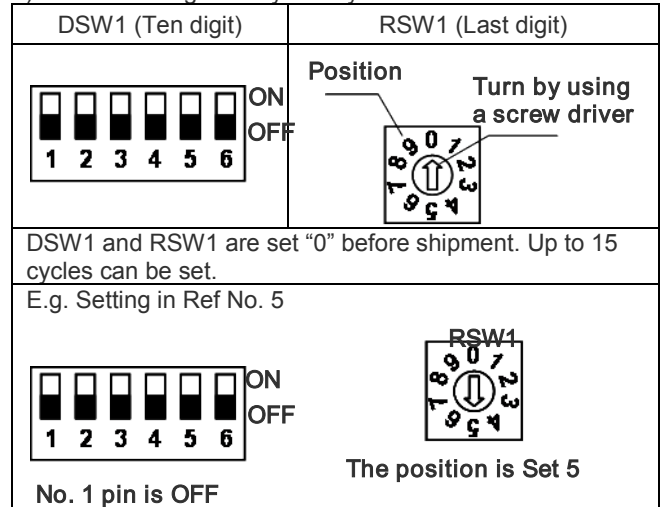

- 4) Set the unit No. by RSW2 and DSW2

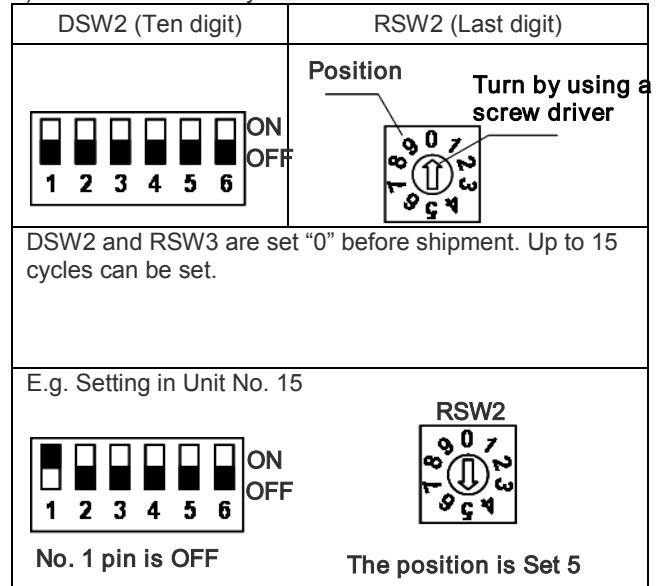

- 5) Slave unit.

In case of setting various RAC adaptors in the same refrigerant cycle, set the RAC adaptor with smallest Unit# as a master unit. In case of setting only one RAC adaptor in a refrigerant system, this adaptor should be a master unit. Set this procedure by DSW3.

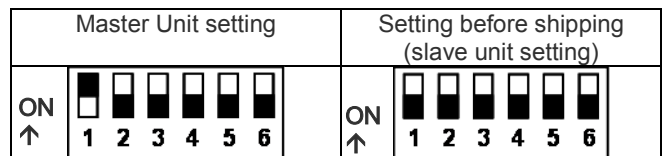

●: Master Unit setting

○: Setting before Shipping (Slave Unit setting)

|                   |   | Indoor Unit# |   |   |   |   |   |   |   |
|-------------------|---|--------------|---|---|---|---|---|---|---|
|                   |   | 0            | 1 | 2 | 3 | 4 | 5 | 6 | 7 |
| Refrigerant Unit# | 0 | ●            | ○ | ○ | ○ | ○ |   |   |   |
|                   | 1 |              |   | ● | ○ | ○ |   |   |   |
|                   | 2 |              |   |   | ● | ○ | ○ | ○ | ○ |
|                   | 3 |              | ● |   |   |   |   |   |   |
|                   | 4 |              |   |   |   |   |   |   |   |

**CAUTION:**

– DO NOT set various main adaptors in the same refrigerant cycle.

- 6) Procedure when applying 200V voltage to H-LINK wiring incorrectly.

In case of applying 200V voltage to H-LINK wiring incorrectly, the fuse installed in a transmission circuit on PCB will blow out. In this case, reconnect the wiring correctly and turn ON No. 2 pin of DSW4 on PCB. The transmission circuit can be recovered. (If applying this error again, the transmission circuit can not be recovered)

**PCB**



Turn ON No.2 pin of DSW4

- 7) Terminating resistance is set in whole H-LINK system.
  - a) If H-LINK connecting devices like package air-conditioner are connected besides the RAC Adaptor, set the terminating resistance by those connecting devices. The terminating resistance should be set ON in only one position in whole H-LINK system.
  - b) In case that H-LINK is connected only by the RAC adaptor, set the terminating resistance by the RAC adaptor. The terminating resistance should be set ON in only one position in whole H-LINK system.

**PCB**

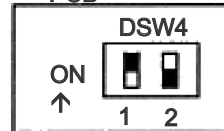

Turn ON No.1 pin of DSW4

**10.2.5. TEST RUN**

Test run should be performed in the following after finishing the installation, wiring and setting. Refer to the installation manuals enclosed with the control system equipment.

- 1) Confirmation of RAC Adaptor Connection
  - Confirm if the RAC adaptor connection is recognized in the control system equipments. In case that it is not confirmed, check the transmission cable, refrigerant cycle #, indoor unit #, terminal resistance setting etc.
- 2) Registration
  - Confirm if the RAC adaptor connection is recognized.
- 3) Confirmation of RUN/STOP Operation.
  - Confirm if the room air-conditioner operate correctly by RUN/STOP from the central control system equipments. Check also if the room air-conditioner operation changes correctly by each setting.

### 10.3. DRY CONTACT (SPX-WDC3) APPLICATION (USING DIP SWITCH)

The dry contact system enables the operation of the air conditioner indoor unit to be controlled by using external dry contacts (with non voltage) such as card-key controller or window for facilities such as hotels.

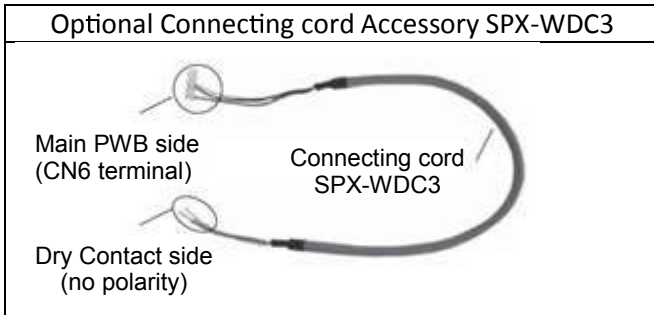

Note:

- 1) AUTO RESTART function set to "Enable" is needed (set pin#1 on the DIP SWITCH SW501 above to OFF position).
- 2) DRY CONTACT function is "Enable" by set pin No. 2 of the DIP SWITCH (DSW1) to ON position.
- 3) Select the proper setting for DRY CONTACT LOGIC INPUT pin No. 3 on DIP SWITCH (DSW1)
  - i) Set to OFF position (Hi Input) if the type of Dry Contact switch to be used (for the CARD KEY UNIT or Window) is of contact type a (Normally Open Type) as shown in below diagram.
  - ii) Set to ON position (Lo Input) if the type of Dry contact switch to be used (for the CARD KEY UNIT or Window) is of contact type b (Normally Close Type) as shown in below diagram.

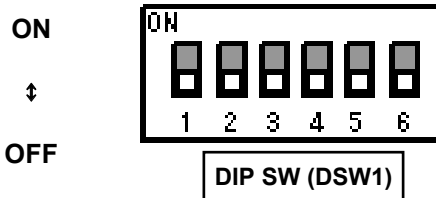

| Pin No. | Function                | Switch Position / Setting |                 |    |                 |
|---------|-------------------------|---------------------------|-----------------|----|-----------------|
|         |                         | OFF                       | Disable         | ON | Enable          |
| 2       | DRY CONTACT function    | OFF                       | Disable         | ON | Enable          |
| 3       | DRY CONTACT Input Logic | OFF                       | HI Input Active | ON | LO Input Active |

- Please decide the type of dry contact you will be using and set the position of the DIP Switch No. 2 and 3 accordingly

[1] CHECK DRY CONTACT OF CARD KEY UNIT

|                | AIR CONDITIONER Standby | AIR CONDITIONER Operating |
|----------------|-------------------------|---------------------------|
|                | CARD KEY (Door Switch)  | REMOVE<br>                |
| Contact type a | OPEN<br>                | CLOSE<br>                 |
| Contact type b | CLOSE<br>               | OPEN<br>                  |

[2] SET THE POSITION OF DIP SWITCH

| POSITION CONDITION OF DIP SWITCH                                |  |
|---|--|
| INITIAL CONDITION (CARD KEY NO USE)<br>No.2 : OFF<br>No.3 : OFF |  |
| HI Input Active<br>No.2 : ON<br>No.3 : OFF                      |  |
| LO Input Active<br>No.2 : ON<br>No.3 : ON                       |  |

After all connection has been done as below diagram, ON the breaker and push ON button of wireless remote controller or wired remote controller to operate the air conditioner unit.

- When the CARD KEY is in insert condition, the air conditioner operation is allowable by remote controller.
- When the dry contact switch on the Card Key Unit is open (refer to diagram below for contact type a), the unit stops to operate (it takes 10 seconds to stop the unit operation after the dry contact switch on the card key turns off) and vice versa.
- When the card key is removed from the Card Key Unit, the wireless remote controller cannot be used.
- When the card key is removed from the Card Key Unit, the wired remote controller LCD display is activated; however it has no control over the unit.
- The suitable accessory Connecting Cord (accessory code#: SPX-WDC3) need to be used to connect the Card Key Unit's dry contact switch to the connector on the control board of the indoor unit. Please refer to Table 1 to select suitable accessory code# for the concerning indoor model.

Example of wiring connection to Card Key Unit will be as below (reference only)

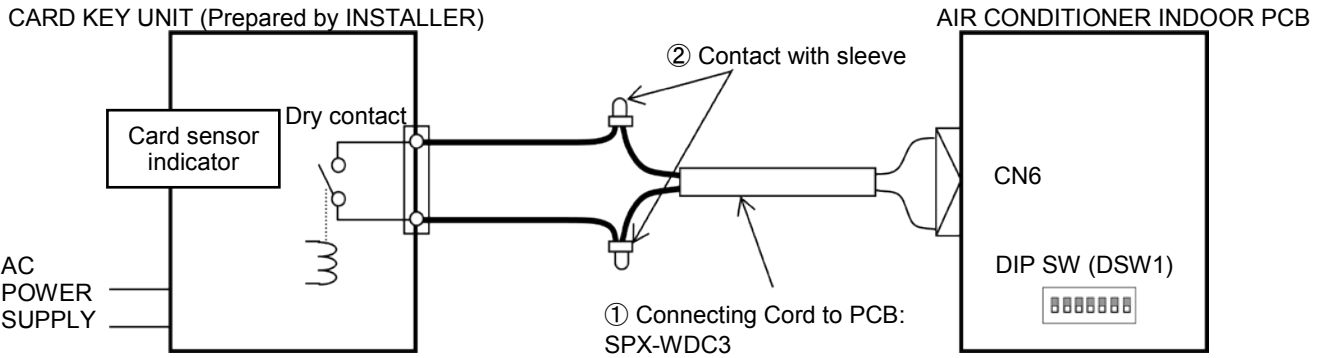

• CONNECTION EXAMPLE

i. Pin No. 3 of DIP SWITCH is set to OFF position (HI Input Active) for Dry Contact Type a

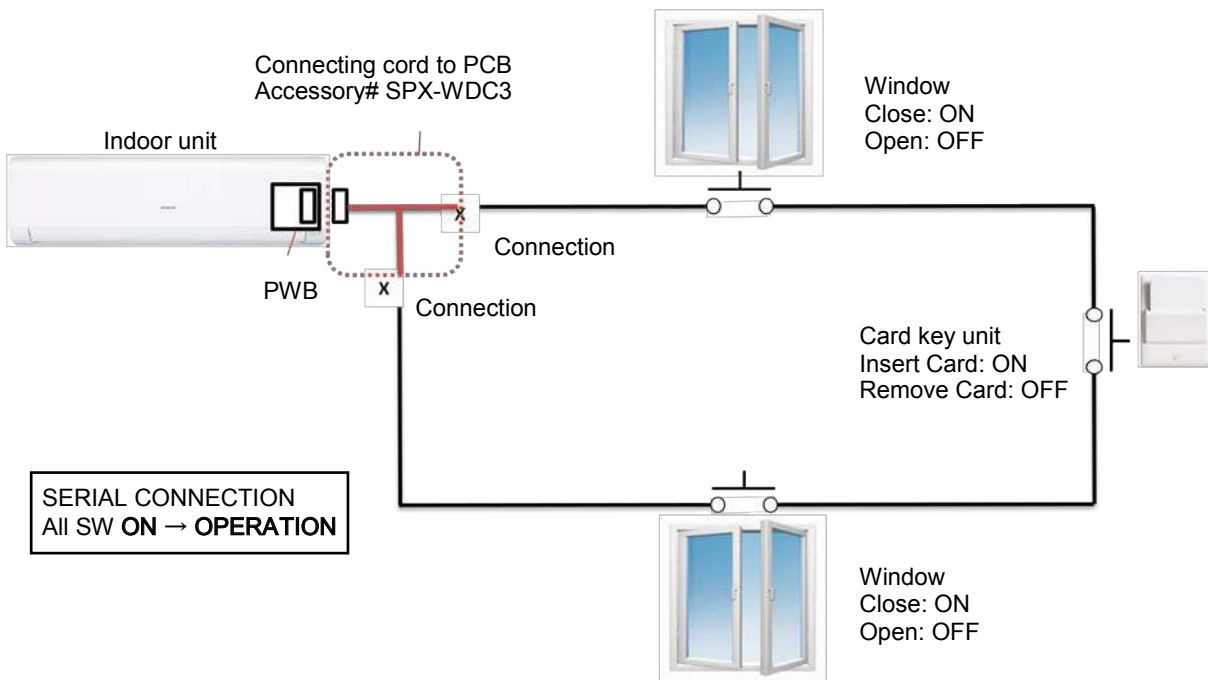

ii. Pin No. 3 of DIP SWITCH is set to ON position (LO Input Active) for Dry Contact Type b

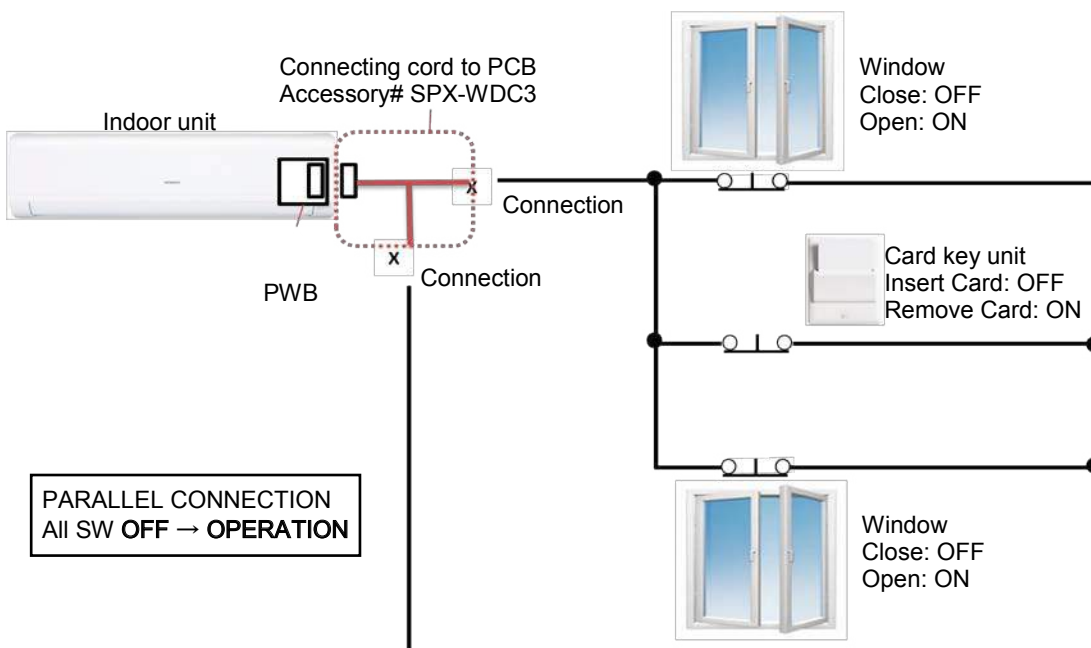

Please refer to the actual manual supplied with the optional connecting cords SPX-WDC3 for more details.

### 10.4. DISTRIBUTOR – SPX-DST1

The optional distributor is to be used together with the wired remote controller when there is a need to centralize the control of multiple indoor units using only a single wired remote controller.

A single distributor could be connected further to 3 separate distributors so that up to 13 units of indoor could be controlled by a single wired remote controller.

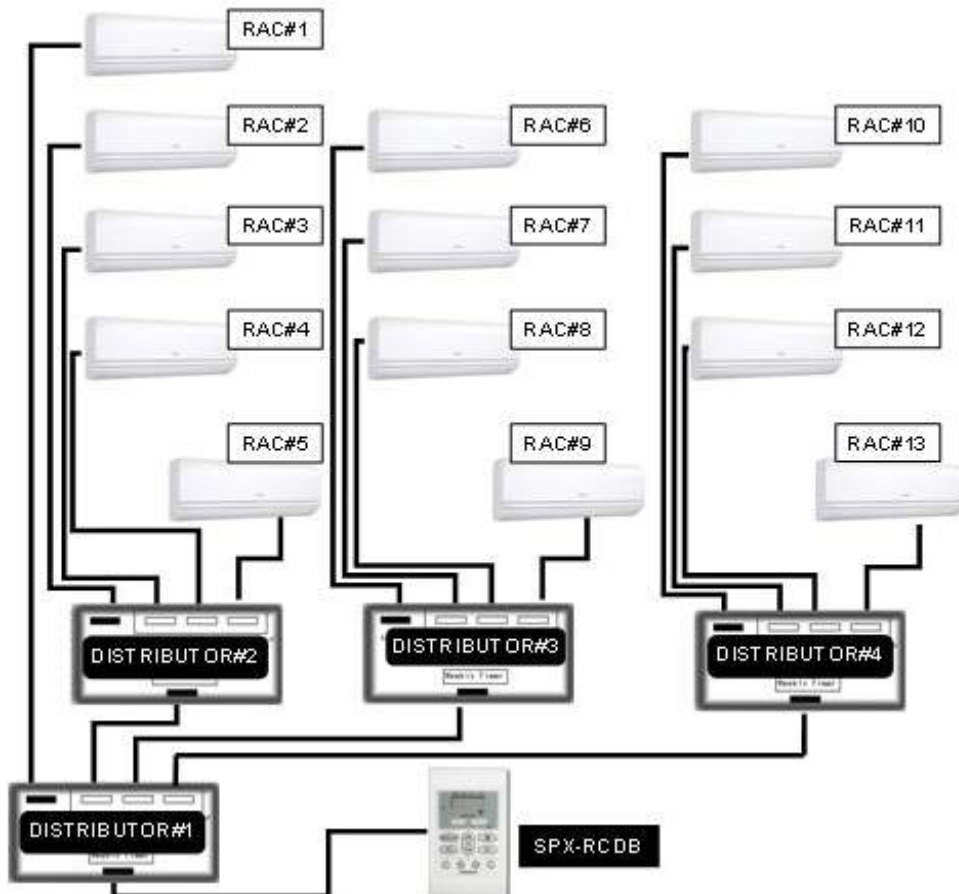
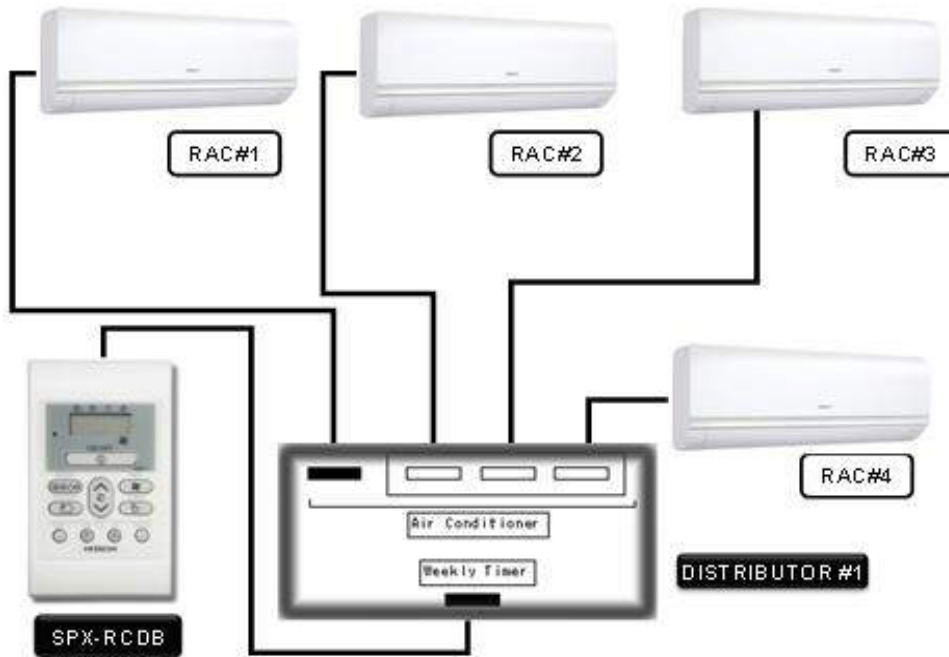

---

# HITACHI

## TC-ERP-Model (2019.02)

### INDOOR

RAK-18RPE  
RAK-25RPE  
RAK-35RPE  
RAK-42RPE  
RAK-50RPE

### OUTDOOR

RAC-18WPE  
RAC-25WPE  
RAC-35WPE  
RAC-42WPE  
RAC-50WPE